

May 2022 - CA



***Cleaning Products
For Professionals
Produits de nettoyage
pour professionnels***

Now Shipping Around the World.



When buying Canadian, rest assured that the products are subject to rigorous health and safety standards.

We have over 40 years of experience, manufacturing a wide range of products to service the entire Janitorial, Sanitation & Industrial markets.

















We stock our entire product line in our 90,000 sq. ft. facility, to ensure quick delivery and great customer service.

Gabriel Marino

Gabriel Marino



INDEX

| | | |
|---|--|------------|
|  | Buckets & Wringers / Seaux &essoreuses Janitor Carts, Utility Carts, Pails, Caution Signs Chariot de ménage, chariot utilitaire, seaux, panneaux d'avertissement..... | 2 |
|  | Waste Management / Gestion des déchets Waste Containers, Litter Scoop, Lobby Dust Pans Contenants à déchets, pelles à litière, promenoir-poussoir..... | 16 |
|  | Magnetic, Angle and Corn Brooms / Balais magnétique, en angle, de maïs Venus, Pluto, Cupid, Hercules, Track Brooms Venus, Pluto, Cupid, Hercules, balais ferroviaires..... | 25 |
|  | Brushes / Brosses Carpet, Utility Deck, Hand Scrubs, Pot, Counter, Window, Masonry, Wire, Scrubs and Specialty Tapis, de pont utilitaire, à main, à casseroles, de comptoir, à vitres, de maçonnerie, à fils d'acier, de récurage et utilitaires..... | 31 |
|  | Push Brooms / Balais-poussoir Ryno, Fine, Medium and Coarse Sweep, Handles Ryno, Brins fins, moyens, grossiers et manches..... | 38 |
|  | Floor Squeegees / Raclettes à plancher Moss Floor Squeegee, Metal Racloir à plancher "Moss", métal..... | 50 |
|  | Wet Mops / Vadrouilles humides Super Looper, Swinger, Swipe, Microfiber, Synray, Cotton Yacht and Specialty Super Looper, Swinger, Swipe, microfibre, Synray, Yacht en coton et spécialité..... | 54 |
|  | Wet Mop Handles / Manches de vadrouilles humides Step-N-Go, Quick Change and Jaw Style Step-N-Go, changement rapide, style mâchoire..... | 75 |
|  | Dust Mops / Vadrouilles à poussière Static-H, M-Tech, G-Stat, Micro-PET, Static-A, Cotton and Handles Static-H, M-Tech, G-Stat, Micro-Pet, Static-A, Coton, et les Manches..... | 77 |
|  | Wall Washing / Lavage des murs Doodle Bug, Dusters Doodle Bug, lavette..... | 85 |
|  | Washroom Care / Entretien des salles d'eau Trigger Sprayers, Bottles, Jugs, Air Deodorizers, Soap Dispensers, Brushes, Urinal, Pulvérisateur à gachette, bouteilles, bidons, purificateur d'air, distributeur de savon, brosses, tamis d'urinoir..... | 89 |
|  | Wiping / Essuyage Microfiber Cloths, Sponges and Scouring Pads Chiffons microfibre, éponges, tampons à récurer..... | 97 |
|  | Window Cleaning / Lavage des fenêtres Handles, T-Bar, Sleeves, Tool Holders, Buckets Poignées, Lames en caoutchouc, support en T, Rechanges, porte-outils, seau à vitres..... | 103 |
|  | Flat Mopping / Tampons plats Slide & Lock, MicroPad, Olympic Frame, Moppads, Buckets & Wringers Slide & Lock, tampons microfibre, chassis Olympic, tampons, seaux etessoreuses..... | 110 |
|  | Food Foodservice / Industrie de l'alimentation Foodservice Pushbrooms, Food Processing (HACCP) Balais-poussoir d'alimentation, transformation des aliments (HACCP)..... | 126 |
|  | M2 Retail / M2 vente au détail Magnetic Brooms, Corn Brooms, Detachable Mops & Buckets, Dish Brushes Balais Magnétiques, Balais De Maïs, Vadrouilles et seaux détachables, Brosse à vaisselle..... | 139 |

THE ELEPHANT FOOT/ LE SYSTÈME PIED D'ÉLÉPHANT

ELEPHANT FOOT COMBOS

- Professional grade mop bucket ideal for the toughest and largest messes
- High grade polypropylene construction prevents corrosion and cracking
- Easy pour spout makes it easy to clean and store
- 3" non-marking casters make it easy to maneuver on any surface and prevents scuffs
- Designed to accommodate any Down Press, Side Press and roller wringer
- High grade polypro Down Press wringer can support a variety of mop sizes
- Reinforced gears improve lifespan of wringer compared to low quality imports

- Seau à vadrouille de qualité professionnelle idéal pour les gros dégâts.
- La construction de polypropylène à haute teneur empêche la corrosion et la fissuration.
- Le bec verseur facile le rend facile à nettoyer et à ranger
- Les roulettes non marquantes de 3" facilitent la manoeuvre sur toutes les surfaces et évitent les éraflures.
- Conçu pour accommoder toutes les essoreuses à pression latérale, descendante ou à rouleau.
- L'essoreuse à pression descendante peut supporter une variété de tailles de vadrouille.
- Les engrenages renforcés améliorent la durée de vie de l'essoreuse par rapport aux importations de faible qualité.



| M2 Code Code M2 | Description | Pack Wt LB (S) Poids (lb) (S) | Pack Wt KG Poids (kg) | Cubic Ft Pi3 | Pack Contenu | List Price Liste des prix |
|--------------------|---|----------------------------------|--------------------------|-----------------|-----------------|------------------------------|
| BW-D41100 - GN | 40 Qt./37L Down Press Elephant Foot Combo - Green / Ensemble d'essoreuse descendante Éléphant, 40 ptes - vert | 18.2 | 8.25 | 3.58 | 1 | \$ 217.49 |
| BW-D41100 - BL | 40 Qt./37L Down Press Elephant Foot Combo - Blue / Ensemble d'essoreuse descendante Éléphant, 40 ptes - bleu | 18.2 | 8.25 | 3.58 | 1 | \$ 217.49 |
| BW-D41100 - RD | 40 Qt./37L Down Press Elephant Foot Combo Red/ Ensemble d'essoreuse descendante Éléphant, 40 ptes - rouge | 18.2 | 8.25 | 3.58 | 1 | \$ 217.49 |
| BW-D41100 - YE | 40 Qt./37L Down Press Elephant Foot Combo - Yellow / Ensemble d'essoreuse descendante Éléphant, 40 ptes - jaune | 18.2 | 8.25 | 3.58 | 1 | \$ 217.49 |
| BW-D41100 - GY | 40 Qt./37L Down Press Elephant Foot Combo Grey / Ensemble d'essoreuse descendante Éléphant, 40 ptes - Gris | 18.2 | 8.25 | 3.58 | 1 | \$ 217.49 |



1YEAR
Warranty On All Grizzly
& Elephant Foot Combos
Garanti D'un An Sur Les
Ensembles Grizzly Et
Éléphant

GRIZZLY / LE SYSTÈME GRIZZLY

GRIZZLY DOWN PRESS COMBOS

- High grade polypropylene construction prevents corrosion and cracking
- 3" non-marking casters make it easy to maneuver on any surface and prevents scuffs
- Designed to accommodate any Down Press, Side Press and roller wringer
- High grade polypro Down Press wringer can support a variety of mop sizes

- La construction de polypropylène à haute teneur empêche la corrosion et la fissuration.
- Les roulettes non marquantes de 3" facilitent la manoeuvre sur toutes les surfaces et évitent les éraflures.
- Conçu pour accommoder toutes lesessoreuses à pression latérale, descendante ou à rouleau.
- L'essoreuse à pression descendante peut supporter une variété de tailles de vadrouille.



| M2 Code Code M2 | Description | Pack Wt LB (S) Poids (lb) (S) | Pack Wt KG Poids (kg) | Cubic Ft Pi3 | Pack Contenu | List Price Liste des prix |
|--------------------|--|----------------------------------|--------------------------|-----------------|-----------------|------------------------------|
| BW-D33100 - GN | 32 Qt Grizzly Down Press Combo – Green / Ensembleseau-essoreuse descendante, 32 pte – vert | 25 | 11.3 | 2.4 | 1 | \$ 174.63 |
| BW-D33100 - BL | 32 Qt Grizzly Down Press Combo – Blue / Ensembleseau-essoreuse descendante, 32 pte – bleu | 25 | 11.3 | 2.4 | 1 | \$ 174.63 |
| BW-D33100 - RD | 32 Qt Grizzly Down Press Combo – Red / Ensembleseau-essoreuse descendante, 32 pte – rouge | 25 | 11.3 | 2.4 | 1 | \$ 174.63 |
| BW-D33100 - YE | 32 Qt Grizzly Down Press Combo – Yellow / Ensembleseau-essoreuse descendante, 32 pte – jaune | 25 | 11.3 | 2.4 | 1 | \$ 174.63 |
| BW-D33100 - GY | 32 Qt Grizzly Down Press Combo – Grey / Ensembleseau-essoreuse descendante, 32 pte – Gris | 25 | 11.3 | 2.4 | 1 | \$ 174.63 |

GRIZZLY SIDE PRESS COMBOS /



| | | | | | | |
|----------------|--|----|------|-----|---|-----------|
| BW-S34100 - GN | 32 Qt/30L Grizzly Side Press Combo – Green / Ensembleseauessoreuse latérale, 32 pte/30L – vert | 25 | 11.3 | 2.4 | 1 | \$ 168.69 |
| BW-S34100 - BL | 32 Qt/30L Grizzly Side Press Combo – Blue / Ensembleseauessoreuse latérale 32 pte/30L – bleu | 25 | 11.3 | 2.4 | 1 | \$ 168.69 |
| BW-S34100 - RD | 32 Qt/30L Grizzly Side Press Combo – Red / Ensembleseauessoreuse latérale 32 pte/30L – rouge | 25 | 11.3 | 2.4 | 1 | \$ 168.69 |
| BW-S34100 - YE | 32 Qt/30L Grizzly Side Press Combo – Yellow / Ensembleseauessoreuse latérale, 32 pte/30L – jaune | 25 | 11.3 | 2.4 | 1 | \$ 168.69 |
| BW-S34100 - GY | 32 Qt/30L Qt Grizzly Side Press Combo – Grey / Ensembleseauessoreuse latérale, 32 pte/30L – Gris | 25 | 11.3 | 2.4 | 1 | \$ 168.69 |



1 YEAR
Warranty On All Grizzly
& Elephant Foot Combos
Garanti D'un An Sur Les
Ensembles Grizzly Et
Éléphant



40QT / 37L LARGE CHAMP DOWN PRESS BUCKETS & WRINGER COMBOS / SEAUX ET ESSOREUSES CHAMP 40QT / 37L

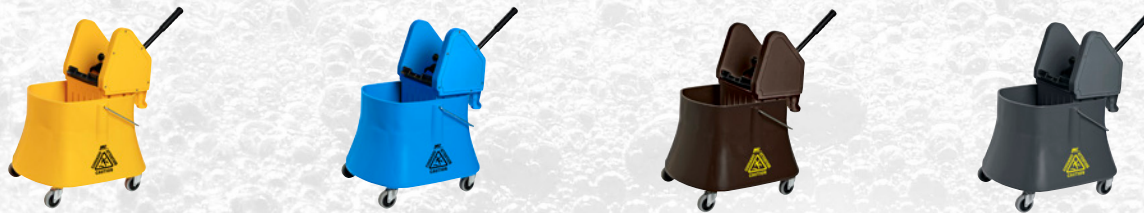

| M2 Code Code M2 | Description | Pack Wt LB (S) Poids (lb) (S) | Pack Wt KG Poids (kg) | Cubic Ft Pi3 | Pack Contenu | List Price Liste des prix |
|--------------------|---|----------------------------------|--------------------------|-----------------|-----------------|------------------------------|
| BW-D1232-40 - YE | 40 Qt./37L Champ Heavy Duty Down Press Combo - Large - Yellow | 18.2 | 8.25 | 3.58 | 1 | \$ 284.67 |
| BW-D1232-40 - BL | 40 Qt./37L Champ Heavy Duty Down Press Combo - Large - Blue | 18.2 | 8.25 | 3.58 | 1 | \$ 284.67 |
| BW-D1232-40 - BR | 40 Qt./37L Champ Heavy Duty Down Press Combo - Large - Brown | 18.2 | 8.25 | 3.58 | 1 | \$ 284.67 |
| BW-D1232-40 - GY | 40 Qt./37L Champ Heavy Duty Down Press Combo - Large - Grey | 18.2 | 8.25 | 3.58 | 1 | \$ 284.67 |

40QT / 37L LARGE CHAMP SIDE PRESS BUCKETS & WRINGER COMBOS / SEAUX ET ESSOREUSES CHAMP 40QT / 37L



| | | | | | | |
|---------------|---|------|------|------|---|-----------|
| BW-S1140 - YE | 40 Qt./37L Champ Heavy Duty Side Press Combo - Large - Yellow | 18.2 | 8.25 | 3.58 | 1 | \$ 216.52 |
| BW-S1140 - BL | 40 Qt./37L Champ Heavy Duty Side Press Combo - Large - Blue | 18.2 | 8.25 | 3.58 | 1 | \$ 216.52 |
| BW-S1140 - BR | 40 Qt./37L Champ Heavy Duty Side Press Combo - Large - Brown | 18.2 | 8.25 | 3.58 | 1 | \$ 216.52 |
| BW-S1140 - GY | 40 Qt./37L Champ Heavy Duty Side Press Combo - Large - Grey | 18.2 | 8.25 | 3.58 | 1 | \$ 216.52 |

26-30 QT SMALL CHAMP DOWN PRESS BUCKETS & WRINGER COMBOS / SEAUX ET ESSOREUSES CHAMP 26-30 QT



| | | | | | | |
|---------------|---|----|------|-----|---|-----------|
| BW-D2633 - YE | 30 Qt./29L Junior Champ Down Press Combo - Yellow | 25 | 11.3 | 2.4 | 1 | \$ 203.47 |
| BW-D2633 - BL | 30 Qt./29L Junior Champ Down Press Combo - Blue | 25 | 11.3 | 2.4 | 1 | \$ 203.47 |
| BW-D2633 - BR | 30 Qt./29L Junior Champ Down Press Combo - Brown | 25 | 11.3 | 2.4 | 1 | \$ 203.47 |
| BW-D2633 - GY | 30 Qt./29L Junior Champ Down Press Combo - Grey | 25 | 11.3 | 2.4 | 1 | \$ 203.47 |

26-30 QT SMALL CHAMP SIDE PRESS BUCKETS & WRINGER COMBOS / SEAUX ET ESSOREUSES CHAMP 26-30 QT



| | | | | | | |
|---------------|--|----|------|-----|---|-----------|
| BW-S1133 - YE | 30 Qt./29L Junior Champ Heavy Duty Side Press Combo - Yellow | 25 | 11.3 | 2.4 | 1 | \$ 116.52 |
| BW-S1133 - BL | 30 Qt./29L Junior Champ Heavy Duty Side Press Combo - Blue | 25 | 11.3 | 2.4 | 1 | \$ 116.52 |
| BW-S1133 - BR | 30 Qt./29L Junior Champ Heavy Duty Side Press Combo - Brown | 25 | 11.3 | 2.4 | 1 | \$ 116.52 |
| BW-S1133 - GY | 30 Qt./29L Junior Champ Heavy Duty Side Press Combo - Grey | 25 | 11.3 | 2.4 | 1 | \$ 116.52 |

ELEPHANT FOOT BUCKET / SEAUX ÉLÉPHANT SUR PIED



| M2 Code Code M2 | Description | Pack Wt LB (S) Poids (lb) (S) | Pack Wt KG Poids (kg) | Cubic Ft Pi3 | Pack Contenu | List Price Liste des prix |
|--------------------|--|----------------------------------|--------------------------|-----------------|-----------------|------------------------------|
| BW-D41102 - GN | 40 Qt./37L Elephant Foot - Bucket Only - Green / Seau Éléphant, 40 ptes/37L- vert | 10.6 | 4.8 | 2.40 | 1 | \$ 114.25 |
| BW-D41102 - BL | 40 Qt./37L Elephant Foot - Bucket Only - Blue / Seau Éléphant, 40 ptes/37L- bleu | 10.6 | 4.8 | 2.40 | 1 | \$ 114.25 |
| BW-D41102 - RD | 40 Qt./37L Elephant Foot - Bucket Only - Red/ Seau Éléphant, 40 ptes/37L- rouge | 10.6 | 4.8 | 2.40 | 1 | \$ 114.25 |
| BW-D41102 - YE | 40 Qt./37L Elephant Foot - Bucket Only - Yellow / Seau Éléphant, 40 ptes/37L-jaune | 10.6 | 4.8 | 2.40 | 1 | \$ 114.25 |
| BW-D41102 - GY | 40 Qt./37L Elephant Foot - Bucket Only - Grey / Seau Éléphant, 40 ptes/37L- Gris | 10.6 | 4.8 | 2.40 | 1 | \$ 114.25 |

GRIZZLY BUCKET / SEAUX GRIZZLY



| | | | | | | |
|----------------|---|---|---|-----|---|----------|
| BW-S32102 - GN | 32 Qt/30L Grizzly - Bucket Only - Green / Seau, 32 pte/30L - vert | 7 | 3 | 2.4 | 1 | \$ 82.33 |
| BW-S32102 - BL | 32 Qt/30L Grizzly - Bucket Only - Blue / Seau, 32 pte/30L - bleu | 7 | 3 | 2.4 | 1 | \$ 82.33 |
| BW-S32102 - RD | 32 Qt/30L Grizzly - Bucket Only - Red / Seau, 32 pte/30L - rouge | 7 | 3 | 2.4 | 1 | \$ 82.33 |
| BW-S32102 - YE | 32 Qt/30L Grizzly - Bucket Only - Yellow / Seau, 32 pte/30L - jaune | 7 | 3 | 2.4 | 1 | \$ 82.33 |
| BW-S32102 - GY | 32 Qt/30L Grizzly - Bucket Only - Grey / Seau, 32 pte/30L - Gris | 7 | 3 | 2.4 | 1 | \$ 82.33 |

40QT / 37L LARGE CHAMP BUCKETS /



| | | | | | | |
|---------------|--|------|------|------|---|-----------|
| BW-D2640 - YE | 40 Qt./37L Champ Heavy Duty - Bucket Only - Yellow | 18.2 | 8.25 | 3.58 | 1 | \$ 130.63 |
| BW-D2640 - BL | 40 Qt./37L Champ Heavy Duty - Bucket Only - Blue | 18.2 | 8.25 | 3.58 | 1 | \$ 130.63 |
| BW-D2640 - BR | 40 Qt./37L Champ Heavy Duty - Bucket Only - Brown | 18.2 | 8.25 | 3.58 | 1 | \$ 130.63 |
| BW-D2640 - GY | 40 Qt./37L Champ Heavy Duty - Bucket Only - Grey | 18.2 | 8.25 | 3.58 | 1 | \$ 130.63 |

26-30 QT SMALL CHAMP BUCKETS /

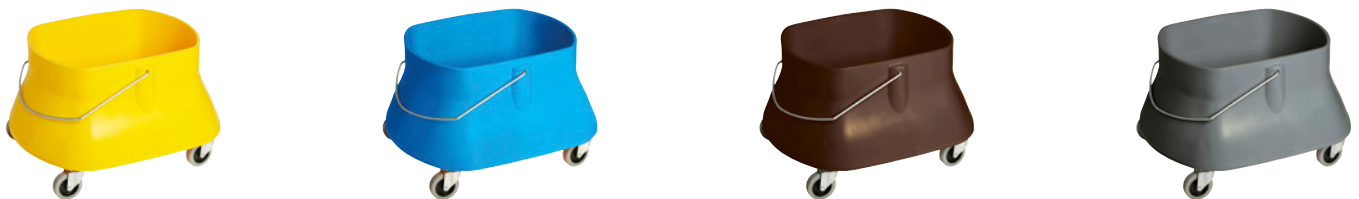

| | | | | | | |
|---------------|---|----|------|-----|---|----------|
| BW-D2632 - YE | 30 Qt./29L Junior Champ Heavy Duty - Bucket Only - Yellow | 25 | 11.3 | 2.4 | 1 | \$ 91.58 |
| BW-D2632 - BL | 30 Qt./29L Junior Champ Heavy Duty - Bucket Only - Blue | 25 | 11.3 | 2.4 | 1 | \$ 91.58 |
| BW-D2632 - BR | 30 Qt./29L Junior Champ Heavy Duty - Bucket Only - Brown | 25 | 11.3 | 2.4 | 1 | \$ 91.58 |
| BW-D2632 - GY | 30 Qt./29L Junior Champ Heavy Duty - Bucket Only - Grey | 25 | 11.3 | 2.4 | 1 | \$ 91.58 |



ELEPHANT FOOT & GRIZZLY DOWN PRESS WRINGERS / FRENCH

- Wrings out mops faster than side squeeze wringers
- More efficient wringing
- avoids water splashing on the floor.

- Plus rapide que la presse d'essorage latérale
- Essorage très efficace
- Pas d'éclaboussures d'eau sur le plancher

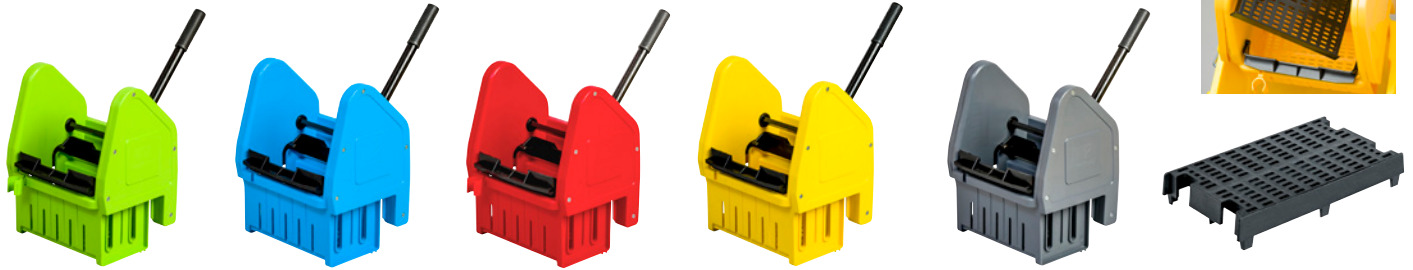

| M2 Code Code M2 | Description | Pack Wt LB (S) Poids (lb) (S) | Pack Wt KG Poids (kg) | Cubic Ft Pi3 | Pack Contenu | List Price Liste des prix |
|--------------------|--|----------------------------------|--------------------------|-----------------|-----------------|------------------------------|
| BW-D33101-GN | Down Press Wringer – Green / Essoreuse pression descendante – vert | 11 | 5 | 2.5 | 1 | \$ 112.06 |
| BW-D33101-BL | Down Press Wringer – Blue / Essoreuse pression descendante – bleu | 11 | 5 | 2.5 | 1 | \$ 112.06 |
| BW-D33101-RD | Down Press Wringer – Red / Essoreuse pression descendante – rouge | 11 | 5 | 2.5 | 1 | \$ 112.06 |
| BW-D33101-YE | Down Press Wringer – Yellow / Essoreuse pression descendante – jaune | 11 | 5 | 2.5 | 1 | \$ 112.06 |
| BW-D33101-GY | Down Press Wringer – Grey / Essoreuse pression descendante – Gris | 11 | 5 | 2.5 | 1 | \$ 112.06 |
| BW-AC3310 | Wringer Insert - Black / Réducteur de presse d'essorage (noir) | | | | 1 | \$ 22.54 |

CHAMP DOWN PRESS WRINGERS /

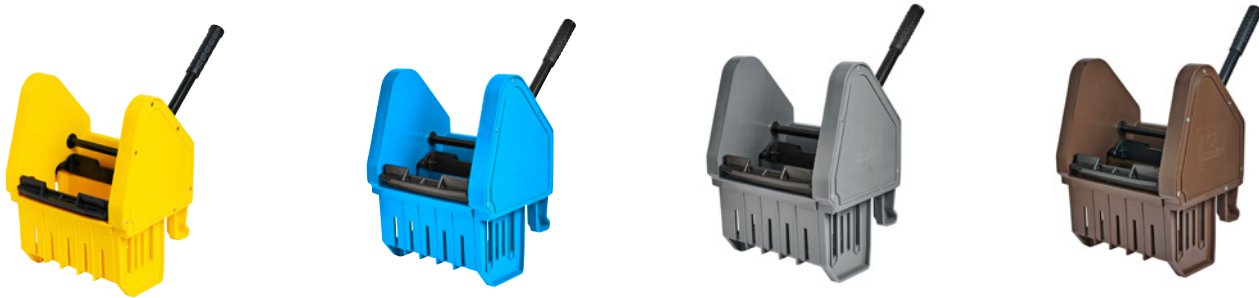

| | | | | | | |
|-------------|--|----|---|-----|---|-----------|
| BW-D1232-YE | Champ Down Press Wringer – Yellow / Essoreuse pression descendante Champ – jaune | 11 | 5 | 2.5 | 1 | \$ 123.73 |
| BW-D1232-BL | Champ Down Press Wringer – Blue / Essoreuse pression descendante Champ – bleu | 11 | 5 | 2.5 | 1 | \$ 123.73 |
| BW-D1232-GY | Champ Down Press Wringer – Grey / Essoreuse pression descendante Champ – gris | 11 | 5 | 2.5 | 1 | \$ 123.73 |
| BW-D1232-BN | Champ Down Press Wringer – Brown / Essoreuse pression descendante Champ – brun | 11 | 5 | 2.5 | 1 | \$ 123.73 |

CHAMP SIDE PRESS WRINGERS /



| | | | | | | |
|--------------|---|----|---|-----|---|----------|
| BW-S73500-GN | Side Press Wringer – Green / Essoreuse pression latérale – vert | 11 | 5 | 2.5 | 1 | \$ 90.88 |
| BW-S73500-BL | Side Press Wringer – Blue / Essoreuse pression latérale – bleu | 11 | 5 | 2.5 | 1 | \$ 90.88 |
| BW-S73500-RD | Side Press Wringer – Red / Essoreuse pression latérale – rouge | 11 | 5 | 2.5 | 1 | \$ 90.88 |
| BW-S73500-YE | Side Press Wringer – Yellow / Essoreuse pression latérale – jaune | 11 | 5 | 2.5 | 1 | \$ 90.88 |
| BW-S73500-GY | Side Press Wringer – Grey / Essoreuse pression latérale – Gris | 11 | 5 | 2.5 | 1 | \$ 90.88 |

SPECIALTY COMBOS / ENSEMBLES SPÉCIAUX

22 QT JUNIOR SIDE PRESS COMBOS / ENSEMBLES COMPACT SEAU-ESSOREUSE LATÉRALE, 22 PINTES

- 22 qt. capacity for smaller areas
- economical alternative design
- ideal for small areas or homes
- 22 pintes, pour de petites superficies
- Conception économique
- Idéal pour les petites superficies et chez soi

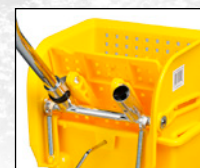

| M2 Code | Description | Pack Qty | Unit Qty | Volume (L) | Volume (qt) | List Price |
|---------------|--|----------|----------|------------|-------------|------------|
| BW-S1011 - YE | 22 Qt Junior Side Press Bucket Combo - Yellow / Ensemble compact seau-essoreuse latérale, 22 pte - jaune | 9 | 4 | 1.3 | 1 | \$ 88.76 |
| BW-S1011 - BL | 22 Qt Junior Side Press Bucket Combo - Blue / Ensemble compact seau-essoreuse latérale, 22 pte - bleu | 9 | 4 | 1.3 | 1 | \$ 88.76 |

26 QT SIDE PRESS COMBO YELLOW / ENSEMBLE ESSOREUSE LATÉRALE, 26 PTES – JAUNE



35 QT BUCKET WITH FUNNEL WRINGER AND WHEELS / 35 PINTES SEAU AVEC ESSOREUSE EN ENTONNOIR



| M2 Code | Description | Pack Wt LB (S) | Pack Wt KG | Cubic Ft | Pack | List Price |
|-----------|---|----------------|------------|----------|---------|----------------|
| Code M2 | | Poids (lb) (S) | Poids (kg) | PI3 | Contenu | Liste des prix |
| BW-S26000 | 26 Qt Side Press Combo / Ensembleessoreuse latérale, 26 ptes-jaune | | | | 1 | \$ 103.13 |
| BW-FU3500 | 35 Qt Bucket with Funnel Wringer and Wheels / 35 pintes Seau avecessoreuse en entonnoir | | | | 1 | \$ 161.96 |

SPECIALTY COMBOS / ENSEMBLES SPÉCIAUX

Deluxe 40 qt. Side Press combo with dirty water
Ensembleessoreuse descendante de luxe 40 pintes avec séparateur d'eau sale.



| M2 Code | Description | Pack Wt LB (S) | Pack Wt KG | Cubic Ft | Pack | List Price |
|--------------|---|----------------|------------|----------|---------|----------------|
| Code M2 | | Poids (lb) (S) | Poids (kg) | PI3 | Contenu | Liste des prix |
| BW-S41000 | Deluxe 40 Qt. Side Press Combo with Dirty Water Divider / Ensembleessoreuse descendante de luxe 40 pintes avec séparateur d'eau sale. | 16.3 | 7.4 | 4.1 | 1 | \$ 162.75 |
| BW-S42202-YE | Deluxe 40 Qt. Bucket for Dirty Water with Divider / | | | | 1 | \$ 162.75 |



BUCKETS & PAILS / SEAUX ET SEAUX



12 L HEAVY DUTY BUCKET WITH CONE WRINGER

- High impact bucket
- Removable Cone Wringer

SEAU ROBUSTE 12 L AVEC ESSOREUSE EN ENTONNOIR

- Seau très résistant
- Essoreuse en entonnoir amovible



7.5 L Each Side /
7.5 L chaque côté

15 L HEAVY DUTY DOUBLE BUCKET WITH CONE WRINGER

- High impact bucket
- Heavy Duty Removable Large Cone Wringer
- Separates Clean & Dirty Water

DOUBLE SEAU ROBUSTE 15 L AVEC ESSOREUSE EN ENTONNOIR

- Seau très résistant
- Grande essoreuse en entonnoir très résistante
- * Séparateur d'eau propre et sale

| M2 Code Code M2 | Description | Pack Wt LB (S) Poids (lb) (S) | Pack Wt KG Poids (kg) | Cubic Ft Pi3 | Pack Contenu | List Price Liste des prix |
|--------------------|--|----------------------------------|--------------------------|-----------------|-----------------|------------------------------|
| PA-M1082 | 12 L Heavy Duty Bucket with Cone Wringer - Blue / 12 L Seau robuste avec essoreuse en entonnoir - bleu | 15.5 | 7 | 3 | 10/1 | \$ 31.94 |
| PA-M1083 | 15 L Heavy Duty Double Bucket with Cone Wringer - Blue / 15 L Double seau robuste avec essoreuse en entonnoir - bleu | 26.7 | 12 | 4 | 10/1 | \$ 46.46 |

MOP CONE PAIL

- High impact bucket
- Fold down handle and cone wringer

SEAU AVEC ESSOREUSE EN FORME D'ENTONNOIR

- Seau très résistant
- Anse rabattable et essoreuse en forme d'entonnoir

DOUBLE BUCKET WITH CONE WRINGER DOUBLE SEAU AVEC ESSOREUSE EN FORME D'ENTONNOIR

DOUBLE BUCKET WITH CONE WRINGER DOUBLE SEAU AVEC ESSOREUSE EN FORME D'ENTONNOIR



Wringer Slides from Side-to-Side
L'essoreuse glisse d'un côté à l'autre



| | | | | | | |
|-------------|--|------|-----|-----|------|----------|
| PA-M1070 | Mop Cone Pail - Blue / Seau avec essoreuse en forme d'entonnoir - bleu | 17 | 8 | 5 | 10/1 | \$ 16.57 |
| PA-M1080 | Double Bucket with Cone Wringer - Yellow / Double seau avec essoreuse en forme d'entonnoir - jaune | 15 | 7 | 2.6 | 5/1 | \$ 38.27 |
| PA-UT1012-2 | 12L Pail with Cone Wringer - Blue / 12L seau avec essoreuse conique - bleu | 10.8 | 4.9 | 1.6 | 10 | \$ 14.44 |
| PA-UT1015 | 15L Pail with Cone Wringer - Blue / 15L seau avec essoreuse conique - bleu | 15 | 6.8 | 3.1 | 12 | \$ 14.68 |

12 L PAIL WITH HANDLE 12L SEAU AVEC POIGNÉE

10 QT PAIL WITH SPOUT SEAU AVEC BEC VERSEUR, 10 PINTES

14 QT HEAVY DUTY PAIL WITH SPOUT SEAU ROBUSTE AVEC BEC VERSEUR, 14 PINTES

15 L HEAVY DUTY PAIL - RED/BLUE SEAU ROBUSTE 15 L - ROUGE/BLEU

16 QT. DOUBLE BUCKET - LARGE/ 16 PTS SEAU DOUBLE - GRAND



| | | | | | | |
|---------------|---|------|-----|-----|------|----------|
| PA-UT1012 | 12L Pail with Handle - Blue / seau bleu seulement avec poignée 12L - bleu | 1.0 | .5 | 2.6 | 24/1 | \$ 11.14 |
| PA-UT10 | 10 Qt Heavy Duty Utility Pail - Red / Seau très résistant, 10 pte - rouge | 10 | 4.5 | 1.8 | 12 | \$ 16.32 |
| PA-UT14 | 14 Qt Heavy Duty Utility Pail - Grey / Seau très résistant, 10 pte - Gris | | | | 12 | \$ 22.00 |
| EFM-PA1015-BL | 15 L Heavy Duty Pail - Blue / Seau robuste 15L bleu | .99 | .44 | 2.6 | 15/1 | \$ 43.57 |
| EFM-PA1015-RD | 15 L Heavy Duty Pail - Red / Seau robuste 15L rouge | .99 | .44 | 2.6 | 15/1 | \$ 43.57 |
| DB-8216 | 16 Qt. Double Bucket - Large / 16 pts Seau double - grand | 19.4 | 8.8 | 3.5 | 5/1 | \$ 32.27 |



| M2 Code Code M2 | Description | Pack Wt LB (S) Poids (lb) (S) | Pack Wt KG Poids (kg) | Cubic Ft Pi3 | Pack Contenu | List Price Liste des prix |
|--------------------|------------------------------------|----------------------------------|--------------------------|-----------------|-----------------|------------------------------|
| PA-3603G | 3 Qt Cleaning Pail - Green | 4 | 1.8 | 7.8 | 1 | \$ 11.83 |
| PA-3603R | 3 Qt Sanitizer Cleaning Pail - Red | 4 | 1.8 | 7.8 | 1 | \$ 11.83 |
| PA-3606G | 6 Qt Cleaning Pail - Green | 3.95 | 2.69 | 9 | 1 | \$ 17.74 |
| PA-3606R | 6 Qt Sanitizer Cleaning Pail - Red | 3.95 | 2.69 | 9 | 1 | \$ 17.74 |

M2 360° EASY SPINMOP - EXPRESS

THE MOP THAT ADDS A "NEW" SPIN TO CLEANING!

- Clean any hard surface with ease!
- Patented bucket with centrifugal technology
- Control the level of moisture in the mop
- Wash & dry the super-absorbent mop in the same bucket!

LA VADROUILLE ROTATIVE RÉVOLUTIONNAIRE!

- Nettoyez toute surface lisse et solide très facilement!
- Seau breveté avec technologie centrifuge
- Contrôlez le niveau d'eau dans la vadrouille
- Lavez et asséchez la vadrouille super-absorbante dans le même deau!

2 Refills With Each Kit
2 Recharges Avec Chaque Kit



CARACTÉRISTIQUES

- Vadrouille lavable en microfibre qui ne laisse aucune égratignure et retient jusqu'à 10 fois son poids!

FEATURES

- Washable microfiber that leaves no scratches & holds up 10 times its weight!

| M2 Code Code M2 | Description | Pack Wt LB (S) Poids (lb) (S) | Pack Wt KG Poids (kg) | Cubic Ft Pi3 | Pack Contenu | List Price Liste des prix |
|--------------------|--|----------------------------------|--------------------------|-----------------|-----------------|------------------------------|
| PA-SM3800 | 360° EasySpin Mop Combo - Black/Red / Ensemble vadrouille "Spin mop" - noir/rouge | 20.7 | 9.3 | 1.2 | 3/1 | \$ 81.75 |
| PA-SM3601 | 360° EasySpin Mop Refill Only - Short / Recharge vadrouille "Easy Spin" courte seulement | .25 | .15 | .03 | 1 | \$ 6.72 |

ROLLER SPONGE MOP / VADROUILLE ÉPONGE RONDE

- Double bucket allows you to separate cleaning solution from dirty water
- Wide spout allows for easier pouring of liquids.
- Comfort grip handle for carrying
- Can be used with the roller sponge mop
- Great for office and small clean ups

- . Le double seau permet de séparer la solution nettoyante de l'eau sale.
- . Le bec large permet un coulage plus facile des liquides.
- . Poignée de maintien confortable pour le transport.
- . Peut être utilisé avec la vadrouille à rouleau.
- . Idéal pour le bureau et les petits nettoyages.

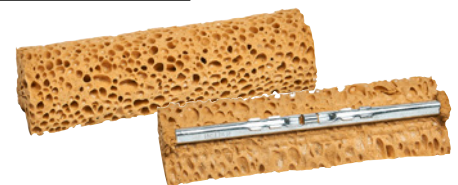

| M2 Code Code M2 | Description | Pack Wt LB (S) Poids (lb) (S) | Pack Wt KG Poids (kg) | Cubic Ft Pi3 | Pack Contenu | List Price Liste des prix |
|--------------------|---|----------------------------------|--------------------------|-----------------|-----------------|------------------------------|
| SM-R1025 | 10" /25cm Roller Sponge mop / Vadrouille éponge ronde 10"/25cm | 11.5 | 5.2 | 4.3 | 12 | \$ 56.58 |
| SM-R1025R | 10" /25cm Roller Sponge mop Refill / Recharge de vadrouille éponge ronde 10"/25cm | 6 | 2.72 | 3.56 | 24 | \$ 23.56 |



WAXING BUCKET WITH SIEVE / SEAU AVEC TAMIS POUR APPLIQUER LA CIRE



- High impact bucket with waxing sieve
- Durable handle for easy carrying
- Sieve can be used with Microfiber mops for floor finish applications
- Removable cap for water drainage on opposite side of bucket
- Swivel casters

- Seau résistant avec tamis pour appliquer la cire
- Transport facile grâce à l'anse durable
- Tamis utilisable avec des vadrouilles en microfibrés pour l'application d'un fini à plancher
- Bouchon de vidange amovible sur l'autre paroi du seau
- Roulettes pivotantes



Refer to page ----- for Duo Microfiber mop
Se reporter à la page 139 pour la vadrouille Duo en microfibre

| M2 Code Code M2 | Description | Pack Wt LB (S) Poids (lb) (S) | Pack Wt KG Poids (kg) | Cubic Ft Pi3 | Pack Contenu | List Price Liste des prix |
|--------------------|---|----------------------------------|--------------------------|-----------------|-----------------|------------------------------|
| PA-WX1100 | Waxing Mop Bucket / Seau pour appliquer la cire | 16.5 | 7.5 | 4.7 | 2/1 | \$ 107.25 |

WINDOW BUCKET /SEAU À VITRES



25 L / 6 US GALLON CAPACITY / CAPACITÉ

- Durable handle for easy carrying
- Swivel wheels for easy maneuverability

- Transport facile grâce à l'anse durable
- Roulettes pivotantes pour une grande maniabilité

| M2 Code Code M2 | Description | Pack Wt LB (S) Poids (lb) (S) | Pack Wt KG Poids (kg) | Cubic Ft Pi3 | Pack Contenu | List Price Liste des prix |
|--------------------|---|----------------------------------|--------------------------|-----------------|-----------------|------------------------------|
| PA-W1120 | Window Bucket with Caddy and Wheels – Yellow / Seau à vitres, jaune | 26.5 | 12 | 3.7 | 5 | \$ 45.37 |

WINDOW BUCKET /SEAU À VITRES

25 L / 6 US GALLON CAPACITY / CAPACITÉ WATERTIGHT SEAL / JOINT ÉTANCHE À L'EAU



| M2 Code Code M2 | Description | Pack Wt LB (S) Poids (lb) (S) | Pack Wt KG Poids (kg) | Cubic Ft Pi3 | Pack Contenu | List Price Liste des prix |
|--------------------|---|----------------------------------|--------------------------|-----------------|-----------------|------------------------------|
| EFM-PS-10100-BL | Window Bucket - Blue / Seau à vitres - bleu | 68.3 | 31 | 1.5 | 10/1 | \$ 53.80 |
| EFM-PS-10101-BL | Window Bucket Lid - Blue / Couvercle pour seau à vitres - bleu | | | | 1 | \$ 28.74 |
| EFM-PS-10102-RD | Window Bucket - Red / Seau à vitres - rouge | 68.3 | 31 | 1.5 | 10/1 | \$ 53.80 |
| EFM-PS-10103-RD | Window Bucket Lid - Red / Couvercle pour seau à vitres - rouge | | | | 1 | \$ 28.74 |
| EFM-PS-10104 | Presoak Bucket Wheels Only (Set of 4) / Roues pour seau de pré-trempage seulement (pq de 4) | | | | 1 | \$ 32.06 |

CARTS / CHARIOTS



CA-M1000
STANDARD
JANITOR CART /
NORME
CHARIOT DE NETTOYAGE -



LARGE JANITOR'S CART

- Front platform holds mop buckets & circular garbage cans
- Easy-to-clean surface
- Reinforced base with heavy duty casters will withstand rugged use
- Multiple hooks for holding dustpans, floor signs, mop handles, caution signs and broom tools
- 3" Casters on the front for easy maneuvering around corners
- Large 8" caster on the back for rugged surfaces
- Includes a heavy duty zippered bag which allows for easy removal of waste

CHARIOT DE NETTOYAGE

- Plateforme avant pour les seaux et les poubelles rondes
- Surface facile à nettoyer
- Base renforcée dotée de roues extra robustes résistant aux usages intensifs
- Plusieurs crochets pour les porte-poussière, les enseignes, les manches de vadrouilles, les panneaux d'avertissement, les vadrouilles et les accessoires
- Roues avant de 3 po pour manœuvrer facilement le chariot dans les coins
- Roues arrière de 8 po pour les surfaces rugueuses
- Comprend un sac robuste à glissière qui permet de retirer facilement les déchets

| M2 Code Code M2 | Description | Pack Wt LB (S) Poids (lb) (S) | Pack Wt KG Poids (kg) | Cubic Ft Pi3 | Pack Contenu | List Price Liste des prix |
|----------------------------------|---|----------------------------------|--------------------------|-----------------|-----------------|------------------------------|
| JAN CART DELUXE / DE LUXE | | | | | | |
| CA-M1000 | Standard Janitor Cart / Chariot de nettoyage. norme | 31 | 14 | 4.7 | 1 | \$ 276.58 |
| CA-M1001 | 70L Deluxe Zippered Janitor Cart Bag Only - 13"x 9"x 30" (35 x 25 x 78cm) 70L Chariot de nettoyage, zippered sac seulement - 13"x 9"x 30" (35 x 25 x 78cm) | 1 | .4 | | 1 | \$ 44.73 |

LARGE JANITOR CART/ CHARIOT DE NETTOYAGE GRAND



| M2 Code Code M2 | Description | Pack Wt LB (S) Poids (lb) (S) | Pack Wt KG Poids (kg) | Cubic Ft Pi3 | Pack Contenu | List Price Liste des prix |
|-------------------------------------|---|----------------------------------|--------------------------|-----------------|-----------------|------------------------------|
| JAN CART / CHARIOT TRADITION | | | | | | |
| CA-M2000 | Large Janitors Cart with Zippered Bag - Yellow / Chariot de nettoyage avec sac à fermeture éclair - jaune | 31 | 14 | 4.7 | 1 | \$ 334.93 |
| CA-M2001 | 65L Large Janitors Cart with Zipper - Bag Only - Yellow - 15"x 10"x 27" (39 x 27 x 70cm) Chariot de nettoyage avec sac à fermeture éclair - Sac seulement - jaune - 15"x 10"x 27" (39 x 27 x 70cm) | 2.30 | 1 | 1 | 1 | \$ 52.11 |



LARGE JANITOR'S CART WITH ZIPPERED BAG & LOCKING CABINET



| M2 Code Code M2 | Description | Pack Wt LB (S) Poids (lb) (S) | Pack Wt KG Poids (kg) | Cubic Ft Pi3 | Pack Contenu | List Price Liste des prix |
|---|--|----------------------------------|--------------------------|-----------------|-----------------|------------------------------|
| LARGE JANITOR CART WITH ZIPPERED BAG & LOCKING CABINET | | | | | | |
| CA-M2200 | Large Black Janitor Cart with Zippered Bag Locking Cabinet - Black / | 33.9 | 15.4 | 5 | 1 | \$ 404.50 |

LAUNDRY COLLECTION CART / CHARIOT PLIANT



- Strong durable X-frame molded with high density plastic
- Easy collapsible frame makes it convenient to store
- Non marking casters for easy movement of cart

- Cadre en X robuste et durable moulé dans du plastique ultra-résistant
- Cadre pliable pour un entreposage facile
- Roues qui ne laissent pas de traces pour déplacer facilement le chariot

| M2 Code Code M2 | Description | Pack Wt LB (S) Poids (lb) (S) | Pack Wt KG Poids (kg) | Cubic Ft Pi3 | Pack Contenu | List Price Liste des prix |
|--------------------|---|----------------------------------|--------------------------|-----------------|-----------------|------------------------------|
| CA-M1800 | X-Cart Mobile Trolley / Chariot mobile pliant, cadre en X | 23.5 | 10.7 | 4.5 | 1 | \$ 283.04 |
| CA-M1801 | X-Cart – Bag Only - 20 x 22 x 28" / 50 x 56 x 72cm / Chariot, cadre en X, sac seulement | 1 | .5 | | 1 | \$ 91.18 |

LARGE HOUSEKEEPING CART



LARGE HOUSEKEEPING CART

Product size:

58.2" x 21.6" x 51.18"
(148cm x 55cm x 130cm)

- 2 large moveable shelves that are smooth and easy to clean
- Molded with high density plastic for extra durability
- Handles on both ends with bag accommodation
- Non-marking wheels, allow for easy movement especially in tight areas

GRAND CHARIOT DE MÉNAGE

Product size:

58.2" x 21.6" x 51.18" (148cm x 55cm x 130cm)

- Deux grandes tablettes mobiles qui sont lisses et faciles à nettoyer
- Moulé avec du plastique haute densité pour une durabilité accrue
- Poignées aux deux extrémités avec logement de sac.
- Des roues non marquantes, permettent un mouvement facile en particulier dans les zones étroites.

| | | | | | | |
|-----------|--|-------|----|------|---|-----------|
| CA-HK5813 | Large HouseKeeping Cart / Grand charriot de ménage | 103.6 | 47 | 10.1 | 1 | \$ 747.44 |
|-----------|--|-------|----|------|---|-----------|

HIGH SECURITY JANITOR CART



HIGH SECURITY JANITOR CART

Product size:

52.5" x 23.6" x 54.3"
(133 x 60 x 138cm)

- Locking cabinet doors and locking security hood
- Bi-directional retractable door to improve the work efficiency

CHARIOT DE MÉNAGE HAUTE SÉCURITÉ

Taille du produit:

52.5" x 23.6" x 54.3"
(133 x 60 x 138cm)

- Porte de cabinet avec barrure penture sécuritaire
- Porte bi-directionnelle retractable pour améliorer l'efficacité du travail

DOOR WITH KEY LOCK / PORTE AVEC SERRURE À CLÉ

| | | | | | | |
|-----------|--|------|----|------|---|-------------|
| CA-HS4800 | High Security Janitor Cart / Chariot de concierge Haute-sécurité | 79.3 | 36 | 11.6 | 1 | \$ 1,244.66 |
| CA-HS4801 | Bag Only for High Security Janitor Cart | | | | 1 | \$ 106.95 |

COLLECTION TROLLEY WITH LOCK



COLLECTION TROLLEY WITH LOCK

Product size:

56.6" x 23.6 x 45.2"
(144 x 60 x 115cm)

- Large Capacity Collection Cart.
- Bag can hold up to 34 Gal. of rubbish

CHARIOT DE COLLECTION AVEC SERRURE

Taille du produit:

56.6" x 23.6 x 45.2"
(144 x 60 x 115cm)

- Chariot de marque Collection grande capacité
- Sac pouvant contenir plus de 34 livres de déchets

| | | | | | | |
|-----------|--|------|------|-----|---|-------------|
| CA-CT4900 | Collection Trolley With Lock / Chariot de ramassage avec serrure | 80.4 | 36.5 | 4.9 | 1 | \$ 1,171.14 |
|-----------|--|------|------|-----|---|-------------|



INDUSTRIAL CART / CHARIOT PLATE-FORME

The M2 Service Utility Cart is ideal for use in a warehouse, the garage, foodservice facilities, perfect for Industrial or medical use or any place a rugged cart is needed. Lightweight design allows this cart to be easily maneuvered on 5" non marking casters.

Les chariots utilitaires de M2 sont idéaux pour être utilisés dans un entrepôt, le garage, le chargement de nourriture, pour un usage industriel ou médical, parfait où tout chariot est nécessaire. La conception légère permet de manutentionner facilement ce chariot sur des roulettes non marquantes de 5".



**Easy assembly.
Assemblage facile.**

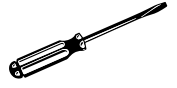

Fixed Front /
Roues fixes à l'avant

Swivel Back /
Roues pivotantes à l'arrière



Casters Included: / Roulettes incluses :
5" x 1 1/4" non marking / non marquantes

| M2 Code Code M2 | Description | Pack Wt LB (S) Poids (lb) (S) | Pack Wt KG Poids (kg) | Cubic Ft Pi3 | Pack Contenu | List Price Liste des prix |
|--------------------|---|----------------------------------|--------------------------|-----------------|-----------------|------------------------------|
| CA-UT1900 | Small Utility Cart / Petit chariot utilitaire - L 34.4" x P 17.5" x H 32.6" (87cm x 44cm x 83cm) | 40.8 | 18.5 | 3.5 | 1 | \$ 283.76 |
| CA-UT1950 | Large Utility Cart / Grand chariot utilitaire - L 40.4" x P 25.5" x H 32.6" (103cm x 65cm x 83cm) | 51.9 | 23.5 | 5.9 | 1 | \$ 348.97 |

SMALL UTILITY CART / PETIT CHARIOT DE SERVICE



**Shelf Weight Capacity 55 lb / 25 kg
Étagère - Capacité de charge 55 lbs/25Kg**

LARGE UTILITY CART / GRAND CHARIOT DE SERVICE



**Shelf Weight Capacity 55 lb / 25 kg
Étagère - Capacité de charge 55 lbs/25 Kg**

DELUXE UTILITY CART / CHARIOT DE SERVICE DE LUXE



**Shelf Weight Capacity 55 lb / 25 kg
Étagère - Capacité de charge 55 lbs/25 Kg**

- Durable handles at both ends • 3 Strong shelves
- Easy to maneuver in tight areas garbage cans
- Assembly required

- Poignées robustes et durables • Trois étagères robustes et durables
- Facile à manœuvrer dans des espaces exigus
- Assemblage requis

| | | | | | | |
|-----------|---|----|------|-----|---|-----------|
| CA-UT1840 | Small Utility Cart / Petit chariot de service | 22 | 10 | 2.6 | 1 | \$ 229.82 |
| CA-UT1850 | Large Utility Cart / Grand chariot de service | 35 | 16 | 4 | 1 | \$ 328.31 |
| CA-UT1860 | Large Deluxe Utility Cart - Black / Grand chariot de service Deluxe, noir | 34 | 15.5 | 6 | 1 | \$ 348.97 |

INDUSTRIAL CART / CHARIOT PLATE-FORME

- Durable frame molded with high density plastic
- Easy collapsible handle makes it convenient to store
- Non marking casters for easy movement of cart
- Cadre durable moulé avec du plastique ultra-résistant
- Poignée rabattable pour un entreposage facile
- Roues qui ne laissent pas de traces pour manœuvrer facilement le chariot.



**250 LB. WEIGHT
CAPACITY 113.4 KG /
Capacité de charge
250 Lbs / 113.4 Kg**



| | | | | | | |
|----------|---|----|----|---|---|-----------|
| CA-13100 | Industrial Box Cart / Chariot plate-forme pour le transport de boîtes | 23 | 11 | 2 | 1 | \$ 211.13 |
|----------|---|----|----|---|---|-----------|

MAID CADDY/TOTES / BOÎTES DE RANGEMENT AVEC POIGNÉE

- Strong durable and lightweight
- Can hold a wide variety of cleaning tools
- Will fit most hotel and janitorial carts
- Robuste, durable et légère
- Peut contenir une vaste gamme de produits de nettoyage
- S'adapte à la plupart des chariots d'hôtel et de ménage

MEDIUM / MOYENNE



LARGE / GRANDE



| | | | | | | |
|--------|--|----|---|-----|------|----------|
| TO-P11 | All Purpose Caddy - Medium - 15"W x 9"D x 5"H / Boîte de rangement tout usage, moyenne, 15 x 9 x 5 (L x P x H) | 18 | 8 | 3.2 | 15/1 | \$ 19.91 |
| TO-P12 | All Purpose Caddy - Large - 16"W x 11"D x 5"H / Boîte de rangement tout usage, grande, 16 x 11 x 5 (L x P x H) | 20 | 9 | 3.5 | 15/1 | \$ 20.08 |

CAUTION WET FLOOR SIGNS 28"/71CM / PANNEAUX «ATTENTION, PLANCHER MOUILLÉ» 28"/71CM

The new pinch free hinge system and taller design makes them stronger, preventing them from flattening out. The four point stance prevents them from leaving marks on waxed floors.

En raison de leur nouveau système de charnières et de leur hauteur, les panneaux sont plus robustes et ne peuvent plus s'affaisser. Les quatre points d'appui permettent qu'ils ne laissent pas de traces sur les planchers cirés.



| M2 Code Code M2 | Description | Pack Wt LB (S) Poids (lb) (S) | Pack Wt KG Poids (kg) | Cubic Ft Pi3 | Pack Contenu | List Price Liste des prix |
|--------------------|--|----------------------------------|--------------------------|-----------------|-----------------|------------------------------|
| WF-7000 | Floor Sign – Blank / Panneau – vide | 12 | 5.5 | 2 | 6 | \$ 21.97 |
| WF-7003-BK | BLACK - "Recycled" Caution Wet Floor – Eng// Fr / Panneau « Attention, plancher mouillé » noir recyclé - anglais / français | 12 | 5.5 | 2 | 6 | \$ 20.39 |
| WF-7003 | Floor Sign "Caution Wet Floor" – Eng/Fr/Sp / Panneau « Attention, plancher mouillé », anglais / français / espagnole | 12 | 5.5 | 2 | 6 | \$ 22.40 |
| WF-7005 | Floor Sign "Caution Wet Floor" – English / Panneau « Caution Wet Floor », anglais | 12 | 5.5 | 2 | 6 | \$ 22.40 |
| WF-7006 | Floor Sign "Closed" – English/French/Spanish / Panneau « Fermé », anglais / français / espagnol | 12 | 5.5 | 2 | 6 | \$ 22.40 |



| | | | | | | |
|---------|---|----|-----|---|---|----------|
| WF-7007 | Floor Sign "Caution Wet Floor" – English/Spanish / Panneau « Caution Wet Floor », anglais / espagnol | 12 | 5.5 | 2 | 6 | \$ 22.40 |
| WF-7008 | Floor Sign "No Entry Restroom Closed" – English / Panneau « Pas d'entrée - toilettes fermées », anglais | 12 | 5.5 | 2 | 6 | \$ 22.40 |
| WF-7011 | Floor Sign "Caution Wet Floor" - French/English | 12 | 5.5 | 2 | 6 | \$ 22.40 |
| WF-7012 | Floor Sign "Cleaning in Progress" - French/English | 12 | 5.5 | 2 | 6 | \$ 22.40 |

SPECIALTY CAUTION SIGNS / ENSEIGNES D'AVERTISSEMENT SPÉCIALISÉES



SAFETY POP-UP SIGN

Product size:
28" x 14" (70 x 35cm)

ENSEIGNE DE SÉCURITÉ "POP-UP"

Taille du produit:
28" x 14" (70 x 35cm)

SAFETY PYLON SIGN

Product size: 30" (76 cm)
Create an obstacle course, mark boundaries, or practice agility with the Hi-Visibility Fluorescent Poly Cone.

PYLÔNE DE SÉCURITÉ

Taille du produit: 30" (76 cm)
Créez un parcours d'obstacles, marquez les limites ou pratiquez l'agilité avec le pylône fluorescent.

| | | | | | | |
|-------------|---|----|---|-----|------|----------|
| WF-C9020 | 4 Sided Safety Caution Sign – Small / Panneau de sécurité à 4 faces - petit | | | | 10/1 | \$ 53.56 |
| WF-C9021 | 4 Sided Safety Caution Sign – Large - Eng/Fr / Panneau de sécurité à 4 faces - grand | | | | 10/1 | \$ 59.45 |
| WF-C9021-SP | 4 Sided Safety Caution Sign – Large - Eng/Sp / Panneau de sécurité à 4 faces - grand | | | | 10/1 | \$ 59.45 |
| WF-D9002 | Hanging Door Sign "Closed for Cleaning" - English / French Enseigne de porte suspendu "Fermé pour le nettoyage" - anglais / français | 11 | 5 | 1.7 | 12/1 | \$ 38.70 |
| WF-P2020 | Safety Pop-Up Sign / Enseigne de sécurité "Pop-up" | | | | 12 | \$ 29.84 |
| WF-C2828 | Safety Pylon Cone Sign 28"(70cm) - Orange / Pylône de sécurité orange 28" (70cm) | | | | 6 | \$ 58.44 |

* All Artwork, Plates and Screens are at addition costs. ** Minimum quantity required. Inquire with your sales representative.
* Les illustrations et les plaques d'impression sont disponibles moyennant le paiement de frais supplémentaires. ** Quantité minimale requise. Se renseigner auprès du représentant des ventes à ce propos.



FOOD SERVICE - COLOUR WASTE CONTAINERS / CONTENEURS DE DÉCHETS COULEURS



| WHITE / BLANC | | | | | | |
|---------------------------------|--|------|-----|-----|-----|-----------|
| WM-PRH1010-WH | 10 Gal. / 38L Ice Bucket – White / Seau à glace, 10 gal./ 38 L , blanc | 6 | 2.8 | 6/1 | | \$ 49.65 |
| WM-PRH2020-WH | 20 Gal. / 75 L Heavy Duty Waste Container – White / Poubelle, 20 gal./ 75 L , blanc | 6 | 2.8 | 6/1 | | \$ 61.51 |
| WM-PRH3232-WH | 32 Gal. / 121 L Heavy Duty Waste Container – White / Poubelle, 32 gal. / 121 L , blanc | 8 | 3.8 | 4/1 | | \$ 82.68 |
| WM-PRH4444-WH | 44 Gal. / 166 L Heavy Duty Waste Container – White/ Poubelle, 44 gal./ 166 L , blanc | 13 | 6 | 3/1 | | \$ 123.59 |
| GREY / GRIS | | | | | | |
| WM-PRH1010-GY | 10 Gal. / 38L Ice Bucket – Grey / Seau à glace, 10 gal./ 38 L , gris | 6 | 2.8 | 6/1 | | \$ 49.65 |
| WM-PRH2020-GY | 20 Gal. / 75 L Heavy Duty Waste Container – Grey / Poubelle, 20 gal./ 75 L , gris | 6 | 2.8 | 6/1 | | \$ 61.51 |
| WM-PRH3232-GY | 32 Gal. / 121 L Heavy Duty Waste Container – Grey / Poubelle, 32 gal. / 121 L , gris | 8 | 3.8 | 4/1 | | \$ 73.13 |
| WM-PRH4444-GY | 44 Gal. / 166 L Heavy Duty Waste Container – Grey/ Poubelle, 44 gal./ 166 L , gris | 13 | 6 | 3/1 | | \$ 109.70 |
| WM-PRH5555-GY | 55 Gal. / 208L Heavy Duty Waste Container – Grey/ Poubelle, 55 gal./ 208 L , gris | 15.3 | 7 | 3.2 | 2/1 | \$ 246.41 |
| GREEN / VERT | | | | | | |
| WM-PRH2020-GN | 20 Gal. / 75 L Heavy Duty Waste Container – Green / Poubelle, 20 gal./ 75 L , vert | 6 | 2.8 | 6/1 | | \$ 61.51 |
| WM-PRH3232-GN | 32 Gal. / 121 L Heavy Duty Waste Container – Green / Poubelle, 32 gal. / 121 L , vert | 8 | 3.8 | 4/1 | | \$ 82.68 |
| WM-PRH4444-GN | 44 Gal. / 166 L Heavy Duty Waste Container –Green/ Poubelle, 44 gal./ 166 L , vert | 13 | 6 | 3/1 | | \$ 123.59 |
| BLUE / BLEU | | | | | | |
| WM-PRH2020-BL | 20 Gal. / 75 L Heavy Duty Waste Container – Blue / Poubelle, 20 gal./ 75 L , bleu | 6 | 2.8 | 6/1 | | \$ 61.51 |
| WM-PR2020-BL-RYC | 20 Gal. / 75 L Heavy Duty Recycled Waste Container – Blue / Poubelle, 20 gal./ 75 L , gris | 6 | 2.8 | 6/1 | | \$ 73.83 |
| WM-PRH3232-BL | 32 Gal. / 121 L Heavy Duty Waste Container –Blue/ Poubelle, 32 gal. / 121 L , bleu | 8 | 3.8 | 4/1 | | \$ 82.68 |
| WM-PR3232-BL-RYC | 32 Gal. / 121 L Heavy Duty Recycled Waste Container – Blue / Poubelle, 32 gal. / 121 L gris | 8 | 3.8 | 3/1 | | \$ 99.21 |
| WM-PRH4444-BL | 44 Gal. / 166 L Heavy Duty Waste Container –Blue/ Poubelle, 44 gal./ 166 L , bleu | 13 | 6 | 3/1 | | \$ 123.59 |
| WM-PR4444-BL-RYC | 44 Gal. / 166 L Heavy Duty Waste Recycled Container – Blue / Poubelle, 44 gal. / 166 L gal, gris | 13 | 6 | 3/1 | | \$ 136.01 |
| RED / ROUGE | | | | | | |
| WM-PRH2020-RD | 20 Gal. / 75 L Heavy Duty Waste Container – Red / Poubelle, 20 gal./ 75 L , rouge | 6 | 2.8 | 6/1 | | \$ 61.51 |
| WM-PRH3232-RD | 32 Gal. / 121 L Heavy Duty Waste Container –Red / Poubelle, 32 gal. / 121 L , rouge | 8 | 3.8 | 4/1 | | \$ 82.68 |
| WM-PRH4444-RD | 44 Gal. / 166 L Heavy Duty Waste Container –Red / Poubelle, 44 gal./ 166 L , rouge | 13 | 6 | 3/1 | | \$ 123.59 |
| YELLOW / JAUNE | | | | | | |
| WM-PRH2020-YE | 20 Gal. / 75 L Heavy Duty Waste Container – Yellow / Poubelle, 20 gal./ 75 L , jaune | 6 | 2.8 | 6/1 | | \$ 61.51 |
| WM-PRH3232-YE | 32 Gal. / 121 L Heavy Duty Waste Container –Yellow/ Poubelle, 32 gal. / 121 L , Jaune | 8 | 3.8 | 4/1 | | \$ 82.68 |
| WM-PRH4444-YE | 44 Gal. / 166 L Heavy Duty Waste Container – Yellow / Poubelle, 44 gal./ 166 L , jaune | 8 | 3.8 | 3/1 | | \$ 123.59 |
| PURPLE / VIOLET - SPECIAL ORDER | | | | | | |
| WM-PRH2020-RD | 20 Gal. / 75 L Heavy Duty Waste Container – Purple / Poubelle, 20 gal./ 75 L , violet | 6 | 2.8 | N/S | | \$ 61.51 |
| WM-PRH3232-RD | 32 Gal. / 121 L Heavy Duty Waste Container –Purple / Poubelle, 32 gal. / 121 L , violet | 8 | 3.8 | N/S | | \$ 82.68 |
| WM-PRH4444-RD | 44 Gal. / 166 L Heavy Duty Waste Container – Purple / Poubelle, 44 gal./ 166 L , violet | 13 | 6 | N/S | | \$ 123.59 |

COLOUR WASTE CONTAINERS LIDS / COUVERTS DE CONTENEURS DE DÉCHETS COULEURS



| M2 Code Code M2 | Description | Pack Wt LB (S) Poids (lb) (S) | Pack Wt KG Poids (kg) | Cubic Ft Pi3 | Pack Contenu | List Price Liste des prix |
|--|---|----------------------------------|--------------------------|-----------------|-----------------|------------------------------|
| WHITE / BLANC | | | | | | |
| WM-PRH1010-L-WH | 10 Gal. / 75 L Waste Container Lid – Heavy Duty - White /Couvercle de poubelle, 10 gal./ 75 L, blanc | 8.8 | 4 | 1.7 | 6/1 | \$ 24.17 |
| WM-PRH2020-L-WH | 20 Gal. / 75 L Waste Container Lid – Heavy Duty - White/ Couvercle de poubelle, 20 gal./ 75 L, blanc | 8.8 | 4 | 1.7 | 4/1 | \$ 27.00 |
| WM-PRH3232-L-WH | 32 Gal. / 121 L Waste Container Lid – Heavy Duty - White / Couvercle de poubelle, 32 gal. / 121 L, blanc | 13 | 6 | 2.2 | 4/1 | \$ 43.66 |
| WM-PRH4444-L-WH | 44 Gal. / 166 L Waste Container – Heavy Duty - White/ Couvercle de poubelle, 44 gal./ 166 L, blanc | 15.3 | 7 | 3.2 | 3/1 | \$ 77.93 |
| GREY / GRIS | | | | | | |
| WM-PRH1010-L-WH | 10 Gal. / 75 L Waste Container Lid – Heavy Duty - Grey /Couvercle de poubelle, 10 gal./ 75 L, gris | 8.8 | 4 | 1.7 | 6/1 | \$ 24.17 |
| WM-PRH2020-L-WH | 20 Gal. / 75 L Waste Container Lid – Heavy Duty - Grey/ Couvercle de poubelle, 20 gal./ 75 L, gris | 8.8 | 4 | 1.7 | 4/1 | \$ 27.00 |
| WM-PRH3232-L-WH | 32 Gal. / 121 L Waste Container Lid – Heavy Duty - Grey / Couvercle de poubelle, 32 gal. / 121 L, gris | 13 | 6 | 2.2 | 4/1 | \$ 43.66 |
| WM-PRH4444-L-WH | 44 Gal. / 166 L Waste Container – Heavy Duty - Grey/ Couvercle de poubelle, 44 gal./ 166 L, gris | 15.3 | 7 | 3.2 | 3/1 | \$ 77.93 |
| WM-PRH5555-L-WH | 55 Gal. / 208 L Waste Container – Heavy Duty - Grey/ Couvercle de poubelle, 55 gal./ 208 L, gris | 15.3 | 7 | 3.2 | 2/1 | \$ 109.09 |
| GREEN / VERT | | | | | | |
| WM-PRH2020-L-GN | 20 Gal. / 75 L Waste Container Lid – Heavy Duty - Green/ Couvercle de poubelle, 20 gal./ 75 L, vert | 8.8 | 4 | 1.7 | 4/1 | \$ 27.00 |
| WM-PRH3232-L-GN | 32 Gal. / 121 L Waste Container Lid – Heavy Duty - Green / Couvercle de poubelle, 32 gal. / 121 L, vert | 13 | 6 | 2.2 | 4/1 | \$ 43.66 |
| WM-PRH4444-L-GN | 44 Gal. / 166 L Waste Container – Heavy Duty - Green/ Couvercle de poubelle, 44 gal./ 166 L, vert | 15.3 | 7 | 3.2 | 3/1 | \$ 77.93 |
| BLUE / BLEU | | | | | | |
| WM-PRH2020-L-BL | 20 Gal. / 75 L Waste Container Lid – Heavy Duty - Blue / Couvercle de poubelle, 20 gal./ 75 L, bleu | 8.8 | 4 | 1.7 | 4/1 | \$ 27.00 |
| WM-PRH3232-L-BL | 32 Gal. / 121 L Waste Container Lid – Heavy Duty - Blue / Couvercle de poubelle, 32 gal. / 121 L, bleu | 13 | 6 | 2.2 | 4/1 | \$ 43.66 |
| WM-PRH4444-L-BL | 44 Gal. / 166 L Waste Container – Heavy Duty - Blue/ Couvercle de poubelle, 44 gal./ 166 L, bleu | 15.3 | 7 | 3.2 | 3/1 | \$ 77.93 |
| RED / ROUGE | | | | | | |
| WM-PRH2020-L-RD | 20 Gal. / 75 L Waste Container Lid – Heavy Duty - Red / Couvercle de poubelle, 20 gal./ 75 L, rouge | 8.8 | 4 | 1.7 | 4/1 | \$ 27.00 |
| WM-PRH3232-L-RD | 32 Gal. / 121 L Waste Container Lid – Heavy Duty - Red / Couvercle de poubelle, 32 gal. / 121 L, rouge | 13 | 6 | 2.2 | 4/1 | \$ 43.66 |
| WM-PRH4444-L-RD | 44 Gal. / 166 L Waste Container – Heavy Duty - Red / Couvercle de poubelle, 44 gal./ 166 L, rouge | 15.3 | 7 | 3.2 | 3/1 | \$ 77.93 |
| YELLOW / JAUNE | | | | | | |
| WM-PRH2020-L-YE | 20 Gal. / 75 L Waste Container Lid – Heavy Duty - Yellow / Couvercle de poubelle, 20 gal./ 75 L, jaune | 8.8 | 4 | 1.7 | 4/1 | \$ 27.00 |
| WM-PRH3232-L-YE | 32 Gal. / 121 L Waste Container Lid – Heavy Duty - Yellow / Couvercle de poubelle, 32 gal. / 121 L, jaune | 13 | 6 | 2.2 | 4/1 | \$ 43.66 |
| WM-PRH4444-L-YE | 44 Gal. / 166 L Waste Container Lid – Heavy Duty - Yellow / Couvercle de poubelle, 44 gal./ 166 L, jaune | 13 | 7 | 2.2 | 3/1 | \$ 77.93 |
| PURPLE / VIOLET - SPECIAL ORDER | | | | | | |
| WM-PRH2020-L-RD | 20 Gal. / 75 L Waste Container – Heavy Duty - Purple / Poubelle, 20 gal./ 75 L, violet | 6 | 4 | 1.7 | N/S | \$ 27.00 |
| WM-PRH3232-L-RD | 32 Gal. / 121 L Waste Container –Heavy Duty - Purple / Poubelle, 32 gal. / 121 L, violet | 8 | 6 | 2.2 | N/S | \$ 43.66 |
| WM-PRH4444-L-RD | 44 Gal. / 166 L Waste Container – Heavy Duty - Purple / Poubelle, 44 gal./ 166 L, violet | 13 | 7 | 2.2 | N/S | \$ 77.93 |

DOME LID

**Garbage Bag Size:
Grandeur sac à déchets:**

20 Gal / 75 L – 30" x 38"
32 GAL / 121 L – 35" x 50"
44 GAL / 166 L – 42" x 48"



| | | | | | | |
|----------------|---------------------------------------|--|--|--|---|-----------|
| WM-PR3232BK-DO | 32 Gallon Garbage Dome Lid-Black | | | | 1 | \$ 275.00 |
| WM-PR4455BK-DO | 44 & 55 Gallon Garbage Dome Lid-Black | | | | 1 | \$ 376.00 |



23 GAL SLIM GARBAGE CONTAINER/ POUBELLE 23 GAL RECTANGULAIRE MINCE



Garbage Bag Size: Grandeur sac à déchets: - 23 GAL / 87 L - SIZE: 30" X 38"

| M2 Code Code M2 | Description | Pack Wt LB (S) Poids (lb) (S) | Pack Wt KG Poids (kg) | Cubic Ft Pi3 | Pack Contenu | List Price Liste des prix |
|--------------------|---|----------------------------------|--------------------------|-----------------|-----------------|------------------------------|
| WM-PR2323-BL-RYC | 23 Gal / 110 Qt Rectangular Slim Garbage Container - Blue / Poubelle rectangulaire mince 23 / 110 Qt gallons-bleu-recycle | 29 | 13.15 | 4.42 | 4/1 | \$ 129.84 |
| WM-PR2323-GN | 23 Gal / 110 Qt Rectangular Slim Garbage Container - Green / Poubelle rectangulaire mince 23 / 110 Qt gallons-vert-recycle | 29 | 13.15 | 4.42 | 4/1 | \$ 129.84 |
| WM-PR2323-GY | 23 Gal / 110 Qt Rectangular Slim Garbage Container - Grey / Poubelle rectangulaire mince 23 / 110 Qt gallons-gris | 29 | 13.15 | 4.2 | 4/1 | \$ 97.17 |
| WM-PR2323-BK | 23 Gal / 110 Qt Rectangular Slim Garbage Container - Black / Poubelle rectangulaire mince 23 gallons / 110 Qt - noire | 29 | 13.15 | 4.42 | 4/1 | \$129.84 |
| WM-PR2324-BL | 23 Gal / 110 Qt Rectangular Slim Garbage Container - Lid Only - Paper Slot/Cans Blue / Couverture pour poubelle mince 23 / 110 Qt bleu-recycle avec trou pour canette et papier | 3 | 1.36 | .42 | 4/1 | \$ 56.00 |
| WM-PR2325-GY | 23 Gal / 110 Qt Rectangular Slim Garbage Container - Swing Lid Only - Grey / Couverture battant pour poubelle mince 23 / 110 Qt - gris | 5 | 2.27 | 1.12 | 4/1 | \$ 56.00 |
| WM-PR2325-BK | 23 Gal / 110 Qt Rectangular Slim Garbage Container - Swing Lid Only - Black / Couverture battant pour poubelle mince 23 / 110 Qt - noir | 5 | 2.27 | 1.12 | 4/1 | \$ 56.00 |
| WM-PR2330D | Rectangular Slim Garbage Container Dolly / | | | | 6/1 | \$ 280.00 |

ACCESSORIES / ACCESSOIRES

DOLLY FOR ROUND WASTE CONTAINERS

- 5-Wheel Dolly, locks into base, support for heavier loads
- Fits most containers

SOCLES POUR POUBELLES RONDES

- Socle 5 roues, se verrouille dans la base et offre un support supplémentaire pour les charges lourdes
- Convient à la plupart des poubelles



| M2 Code | Description | Pack Wt LB (S) | Pack Wt KG | Cubic Ft | Pack | List Price |
|---------------|--|----------------|------------|----------|------|------------|
| WM-D4000 | Dolly for Waste Container / Socle pour poubelle | 43.6 | 20 | 6 | 6/1 | \$ 72.38 |
| WM-AC4001 | Caddy for 20, 32 and 44 Gallon Container - Yellow / Socle pour poubelles de 20, 32, 44 gal - jaune | 1.5 | 1 | .2 | 1 | \$ 60.02 |
| TO-P1850 | Portable cleaning/storage caddy/For 32Gal,44Gal,Containers | | | | 4/1 | \$ 73.51 |
| WM-PR2020G-FL | 20 Gal. / 75 L Waste Container Lid - Grey / Couverture de poubelle, 20 gal./ 75 L, gris | 8.8 | 4 | 1.7 | 6/1 | \$ 51.90 |
| WM-PR3232G-FL | 32 Gal. / 121 L Waste Container Lid - Grey / Couverture de poubelle, 32 gal. / 81 L, gris | 13 | 6 | 2.2 | 6/1 | \$ 62.20 |

“EZ-Push” Waste Containers Conteneurs à déchets “Ez-push”



H - 17.75" W - 13.25" - D - 11.25"
45.5 cm x 33.6 cm x 28.5 cm
Bag Size / Taille du sac
22" x 24" / 55 x 60cm

H - 23.5" W - 16" - D - 13
59.6 cm x 40.6 cm x 32 cm
Bag Size / Taille du sac
26" x 36" / 66 x 91.5cm

H - 27.5" W - 16" - D - 16"
70 cm x 40.6 cm x 40.6 cm
Bag Size / Taille du sac
30" x 38" / 76 x 96.5cm

H - 34" W - 19.25" - D - 19.25"
86 cm x 49 cm x 49 cm
Bag Size / Taille du sac
42" x 48" / 106.5 x 122cm

H - 31" W - 13.25" - D - 18"
79 cm x 33.6 cm x 46 cm

*Dimensions include lids /
Les dimensions incluent les couvercles*

M2's New EZ-Push Square Waste Containers complete with Lids are made of durable plastic. They feature a smooth push-open door which conceals trash and contain odors. The removable lid makes for easy cleaning and effortless trash removal.

The ergonomically designed handles make lifting simple. Our EZ-Push Waste Containers are available in 25L, 40L, 60L, 100L and a Slim Rectangular 60L size to fit in tight spaces. Ideal in both indoor or outdoor. Colour: Grey

La nouvelle M2, « Ez-push » de conteneurs à déchets carrés complets, avec des couvercles, sont en plastique durable. Ils disposent d'une porte poussoir lisse qui cache la poubelle et masque les odeurs. Le couvercle amovible permet un nettoyage facile et l'enlèvement des ordures sans effort. Les poignées ergonomiques rendent le soulèvement facile.

Notre « Ez-push » de conteneurs à déchets sont disponibles en 25L, 40L, 60L, 100L et une taille de 60L rectangulaire mince pour tenir dans des espaces restreints. Idéal à la fois à l'intérieur ou à l'extérieur. Couleur : Gris

| M2 Code Code M2 | Description | Bag Size Bag Size | Pack Wt LB (S) Poids (lb) (S) | Pack Wt KG Poids (kg) | Cubic Ft Pi3 | Pack Contenu | List Price Liste des prix |
|--------------------|--|----------------------|----------------------------------|--------------------------|-----------------|-----------------|------------------------------|
| WM-PS0025 | 25L Waste Container with Lid – Grey / Poubelle carrée avec couvercle, 25L, gris | 22" x 24" | 26.9 | 11.3 | 3.9 | 10/1 | \$ 32.33 |
| WM-PS0040 | 40L Waste Container with Lid – Grey / Poubelle carrée avec couvercle, 40L, gris | 26" x 36" | 52.5 | 23.8 | 10.5 | 10/1 | \$ 58.63 |
| WM-PS0060 | 60L Waste Container with Lid – Grey / Poubelle carrée avec couvercle, 60L, gris | 30" x 38" | 52.5 | 23.8 | 10.5 | 5/1 | \$ 83.89 |
| WM-PS0100 | 100L Waste Container with Lid – Grey / Poubelle carrée avec couvercle, 100L, gris | 42" x 48" | 52.5 | 23.8 | 10.5 | 5/1 | \$ 121.39 |
| WM-PRO260 | 60L Rectangular Waste Container with Lid – Grey / Poubelle rectangulaire avec couvercle, 60L, gris | 30" x 38" | 52.5 | 23.8 | 10.5 | 4/1 | \$ 85.56 |



WASTE BASKETS / PANIER À DÉCHETS

8 QT. / 8 PINTES

14 QT. / 14 PINTES

28 QT. / 28 PINTES

38 QT. / 41 PINTES



| M2 Code Code M2 | Description | Pack Wt LB (S) Poids (lb) (S) | Pack Wt KG Poids (kg) | Cubic Ft Pi3 | Pack Contenu | List Price Liste des prix |
|--------------------|--|----------------------------------|--------------------------|-----------------|-----------------|------------------------------|
| WM-PS008 | 8 Qt / 7.5 L Waste Basket, Black / Panier à déchets 8 pts/7.5 L, noir | 15.54 | 7.05 | 1.78 | 20/1 | \$ 9.82 |
| WM-PS014 | 14 Qt / 11 L Waste Basket, Black / Panier à déchets 14 pts / 11 L, noir | 25.72 | 11.44 | 3.19 | 20/1 | \$ 12.04 |
| WM-PS028 | 28 Qt / 26 L Waste Basket, Black / Panier à déchets 28 pts / 26 L, noir | 27.18 | 10.06 | 2.62 | 10 | \$ 20.55 |
| WM-PS028-BE | 28 Qt / 26 L Waste Basket, Beige / Panier à déchets 28 pts / 26 L, beige - Special Order / Commande spéciale | 27.18 | 10.06 | 2.62 | 10 | \$ 20.55 |
| WM-PS038 | 38 Qt / 36 L Waste Basket, Black / Panier à déchets 38 pts / 36 L, noir | 28.79 | 13.06 | 3.88 | 10 | \$ 23.88 |

RECYCLED WASTE BASKETS / BAC À RECYCLAGE



| M2 Code Code M2 | Description | Pack Wt LB (S) Poids (lb) (S) | Pack Wt KG Poids (kg) | Cubic Ft Pi3 | Pack Contenu | List Price Liste des prix |
|--------------------|--|----------------------------------|--------------------------|-----------------|-----------------|------------------------------|
| WM-PS028-BL-RYC | 28 Qt / 26 L Waste Basket, Blue/ Panier à déchets 28 pts / 26 L, bleu | 27.18 | 10.06 | 2.62 | 10 | \$ 20.55 |
| WM-PS038-BL-RYC | 38 Qt / 36 L Waste Basket, Blue / Panier à déchets 38 pts / 36 L, bleu | 28.79 | 13.06 | 3.88 | 10 | \$ 23.88 |

RECYCLE BINS

SADDLE TOTE

Use this small saddle tote on almost any recycle bin to separate and collect secondary materials such as waste, organics or batteries.

FOURRE-TOUT

Utilisez ce petit fourre-tout sur presque n'importe quel bac pour séparer les déchets, les matières organiques ou les batteries.



5 GALLON UNDER DESK RECYCLE BIN

This compact recycle bin is perfect to use in small spaces.

BAC DE RECYCLAGE DE BUREAU 5 GALLONS

Ce bac compact est parfait pour les petits espaces.



KITCHEN FOOD WASTE CONTAINER / CONTENANT DE DÉCHET DE CUISINE



| M2 Code Code M2 | Description | Pack Wt LB (S) Poids (lb) (S) | Pack Wt KG Poids (kg) | Cubic Ft Pi3 | Pack Contenu | List Price Liste des prix |
|--------------------|---|----------------------------------|--------------------------|-----------------|-----------------|------------------------------|
| RYC-0311 | 4L / 1 Gal Saddle Tote - Black / Fourre-Tout - 4L / 1 gal - noir | | | | 1 | \$ 9.95 |
| RYC-0517 | 5 Gallon/(17L) Under Desk Recycle Bin / 5 gallons / 17 litres - Bac de recyclage sous le comptoir | | | | 1 | \$ 20.42 |
| RYC-0108-BE-GN | Kitchen Food Waste Container-8L/2.11US Gal. Beige & Green 2.11 gallons US / 8 litres - Contenant de déchet de cuisine beige & vert | | | | 1 | \$ 20.19 |

STATIONARY BINS / BACS STATIONNAIRES

16 GALLON CURBSIDE RECYCLE BIN / BAC DE RECYCLAGE SÉLECTIF 16 GALLONS

22 GALLON CURBSIDE RECYCLE BIN / BAC DE RECYCLAGE SÉLECTIF 22 GALLONS

16 GALLON CURBSIDE RECYCLE BIN LID / 16 COUVERT POUR BAC DE RECYCLAGE SÉLECTIF 16 & 22 GALLONS

Lids fit both 16 and 22 Gal Containers /

Les couvercles conviennent aux conteneurs de 16 et 22 gallons

3 Decals Included / 3 décalcomanies incluses



| M2 Code Code M2 | Description | Pack Wt LB (S) Poids (lb) (S) | Pack Wt KG Poids (kg) | Cubic Ft Pi3 | Pack Contenu | List Price Liste des prix |
|--------------------|--|----------------------------------|--------------------------|-----------------|-----------------|------------------------------|
| RYC-1660 | 16 Gallon Curbside Recycle Bin / 16 gallons - bac de recyclage sélectif | | | | 1 | \$ 32.50 |
| RYC-2290 | 22 Gallon Curbside Recycle Bin / 22 gallons - bac de recyclage sélectif | | | | 1 | \$39.92 |
| RYC-1622-L | 16 and 22 Gallon Curbside Recycle Bin Lid only / 16 et 22 gallons - couvert pour bac de recyclage sélectif | | | | 1 | \$16.26 |
| RYC-2290-L | 16 and 22 Gal. Curbside Recycle Lid Only with Hole for Bottles and Cans / 16 et 22 Gal. Couvercle de recyclage en bordure de rue seulement avec trou pour bouteilles et canettes | | | | 1 | \$ 31.80 |

STACK & NEST RECYCLE BINS / BAC DE RECYCLAGE SÉLECTIF

12 GALLON STACK AND NEST RECYCLE BIN

A stackable recycle bin designed for sorting and storing recyclables. vertical storage design uses minimal floor space while maximizing capacity. Made from 100% high density polyethylene and BPA free.

BAC DE RECYCLAGE SÉLECTIF 22 GALLONS

Un bac empilable conçu pour le tri et le stockage des matières recyclables. La conception de stockage vertical utilise un minimum d'espace au sol tout en maximisant la capacité. Fabriqué à partir de 100% de polyéthylène haute densité et sans BPA.



| M2 Code Code M2 | Description | Pack Wt LB (S) Poids (lb) (S) | Pack Wt KG Poids (kg) | Cubic Ft Pi3 | Pack Contenu | List Price Liste des prix |
|--------------------|---|----------------------------------|--------------------------|-----------------|-----------------|------------------------------|
| RYC-1248 | 12 Gallon (48L) Stack and Nest Recycle Bin / 12 gallons / 48 litres - Bac de recyclage à empiler et imbriquer | | | | 1 | \$33.61 |



STEP-ON GARBAGE CANS / POUBELLE A PÉDALE

STEP-ON CANS ARE STRONG AND DURABLE –
TIGHT FIT LID KEEPS ODOUR CONTAINED

POUBELLES STEP-ON-CAN SONT FORT ET DURABLE
– AVEC UNE COUVERCLE QUI FERME SERRÉ POUR
EMPECHER LES ODEURS DE S ÉCHAPPER



| M2 Code Code M2 | Description | Pack Wt LB (S) Poids (lb) (S) | Pack Wt KG Poids (kg) | Cubic Ft Pi3 | Pack Contenu | List Price Liste des prix |
|--------------------|---|----------------------------------|--------------------------|-----------------|-----------------|------------------------------|
| WM-ST3008 | 30L / 8 Gal. Step-On Garbage Can - Plastic - Grey / Poubelle a pédale 30L /8 Gal - Plastique - Gris | | | | 4/1 | \$129.62 |
| WM-ST4512 | 45L / 12 Gal. Step-On Garbage Can - Plastic - Grey / Poubelle a pédale 45L /12 Gal - Plastique - Gris | | | | 3/1 | \$ 155.54 |
| WM-ST6818 | 68L / 18 Gal. Step-On Garbage Can - Plastic - Grey / Poubelle a pédale 68L /18 Gal - Plastique - Gris | | | | 3/1 | \$ 232.31 |

WHEELER GARBAGE CANS / CONTENANT À DÉCHET SUR ROUES

Two Wheeled Garbage cans make it quick and easy to collect and transport waste. Made of commercial grade injection molded HDPE plastic makes them extremely durable and prevents cracking and denting. Ideal for indoor and outdoor uses.

Les poubelles à deux roues, facilitent la collecte et le transport des déchets. Fabriqués en plastique HDPE moulé par injection de qualité commerciale, elles sont extrêmement durables et évitent les fissures et les bosselures. Idéales pour les utilisations intérieures ou extérieures.

13 GALLON CURBSIDE ORGANICS BIN

A manual organics collection container designed for household organics collection.

Made from 100% high density polyethylene, this container is BPA Free and easy to clean. Designed with the most durable wheels on the market, larger collection handles and a taller design, collection.

FONDEUR DE GLACE / BAC DE NOURRITURE POUR ANIMAUX

Un bac manuel de collecte de matières organiques conçu spécialement pour cet usage. Fabriqué à partir de polyéthylène haute densité 100%. ce bar est sans BPA et facile à nettoyer. Conçu avec les roues les plus durable sur le marché, des poignées de collection plus grandes et un design plus haut.



| M2 Code Code M2 | Description | Pack Wt LB (S) Poids (lb) (S) | Pack Wt KG Poids (kg) | Cubic Ft Pi3 | Pack Contenu | List Price Liste des prix |
|--------------------|--|----------------------------------|--------------------------|-----------------|-----------------|------------------------------|
| WM-TW12032 | 120L / 32 Gal. 2 Wheeler Garbage Can - Plastic - Grey / Poubelle a pédale 120L /32 Gal - Plastique - Gris | | | | 3/1 | \$ 310.93 |
| WM-TW24064 | 240L / 64 Gal. 2 Wheeler Plastic Garbage Can - Plastic - Grey / Poubelle a pédale 240L /64 Gal - Plastique - Gris | | | | 4/1 | \$ 410.43 |
| WM-TW20855 | 208L/55 Gal Rollout Garbage Can - Grey | | | | 4/1 | \$ 410.43 |
| RYC-1360-GN | 60 Litre / 13 U.S. Gallon Food Waste Container with Lock - Green 60 litres / 60 gallons - Conteneur à déchets alimentaire avec serrure - vert | | | | 1 | \$ 97.15 |

M2 GALAXY LOBBY DUSTPAN / PROMENOIR M2 GALAXY

GALAXY LOBBY DUST PAN

- Redesigned Plastic Lobby Dustpan
- Hang-up cap handle for easy storage
- Easy to release dirt
- Lightweight design

PROMENOIR VERTICAUX - GALAXY

- Promenoir vertical de plastique redessiné
- Poignée de suspension pour un entreposage facile
- Facile à vider
- Conception légère

Sure-Lock Hinge /
Sure Lock Charnière



DP-L700

DP-L800

DP-L802

DP-L950

DP-L810

| M2 Code Code M2 | Description | Pack Wt LB (S) Poids (lb) (S) | Pack Wt KG Poids (kg) | Cubic Ft Pi3 | Pack Contenu | List Price Liste des prix |
|--------------------|---|----------------------------------|--------------------------|-----------------|-----------------|------------------------------|
| DP-L700 | Lobby dust pan with foldable handle / Promenoir avec manche repliable | | | | 16 | \$ 7.14 |
| DP-L800 | Galaxy Plastic Lobby Dust Pan with Handle (Broom not included) / Promenoir vertical en plastique avec manche Galaxy (balai non compris) | 2.4 | 1 | 2.7 | 6 | \$ 26.52 |
| DP-L800-CH | Galaxy Plastic Lobby Dust Pan with Coloured 30" Fiberglass Handle | | | | 6 | \$ 44.91 |
| DP-L800-PL | Galaxy Lobby dust pan with foldable handle / Promenoir avec manche repliable Galaxy | | | | 16 | \$ 36.45 |
| DP-L802 | Galaxy Combo: Plastic Pan, Angle Broom and Handle / Ensemble promenoir vertical en plastique, balai en angle et manche Galaxy | 4.2 | 2 | 2.7 | 6 | \$ 40.39 |
| DP-L950 | Jumbo Lobby Dustpan 13 1/2" x 14" Deep / Promenoir vertical géant 13 1/2" x 14" profondeur | | | | 10 | \$ 45.64 |
| DP-L810 | Metal Lobby Dustpan with Lid / Porte-poussière d'entrée en métal avec couver | 24 | 11 | 4 | 6/1 | \$ 53.43 |



DP-L830



DP-L831



BA-3036

| M2 Code Code M2 | Description | Pack Wt LB (S) Poids (lb) (S) | Pack Wt KG Poids (kg) | Cubic Ft Pi3 | Pack Contenu | List Price Liste des prix |
|--------------------|--|----------------------------------|--------------------------|-----------------|-----------------|------------------------------|
| DP-L830 | Galaxy Plastic Lobby Dustpan - 2 Piece Handle - All-In-One Box / | | | | 6 | \$ 29.43 |
| DP-L831 | Galaxy Combo Plastic Lobby Dustpan, with Angle Broom - 2 Piece Handle - All-In-One Box / | | | | 6 | \$ 29.43 |
| BA-3036 | 8"/20 cm Angle Broom with 36"/91 cm Handle / Balai en angle, 8 po / 20 cm, manche de 36 po/91 cm | 30 | 13.5 | 1.5 | 24/12 | \$ 8.01 |



METAL & PLASTIC DUSTPANS / PROMENOIR EN MÉTAL AVEC COUVERT

The sharp edge of our plastic and metal dustpans makes them ideal for sweeping fine particles without leaving dirt on the floor.

Avec leur arête vive, les porte-poussière en plastique et en métal sont parfaits pour balayer les particules fines et ramasser toute la poussière sur le sol.

**COUNTER DUSTPAN SET
ENSEMBLE PORTE-POUSSIÈRE ET
BROSSE-COMPTOIR**



**9" CLIP-ON
CLIP-ON, 9 PO**



**9" CLIP-ON -BB
CLIP-ON, 9 PO -BB**



**13" PLASTIC CLIP-ON
PLASTIQUE CLIP-ON, 13 PO**



**12" PLASTIC
PLASTIQUE, 12 PO**



| M2 Code Code M2 | Description | Pack Wt LB (S) Poids (lb) (S) | Pack Wt KG Poids (kg) | Cubic Ft Pi3 | Pack Contenu | List Price Liste des prix |
|--------------------|--|----------------------------------|--------------------------|-----------------|-----------------|------------------------------|
| BR-CO206D | Counter Brush with Dust Pan / Ensemble porte-poussière et brosse-comptoir | 1 | | 1.7 | 24/12 | \$ 5.53 |
| DP-H509 | 9" Clip-on Medium Dust Pan – White / Porte-poussière "Clip-on", 9 po, medium - blanc | | | | 24/12 | \$ 3.95 |
| DP-H509-BB | 9" Clip-on Medium Dust Pan – Baby Blue / | | | | 24/12 | \$ 3.95 |
| DP-H514-BK | 14" Clip-on Dust Pan – Large with Shark Teeth - Black | | | | 24/12 | \$ 6.09 |
| DP-H614 | 12" Plastic Dustpan – Black / Porte-poussière en plastique, 12 po, noir | 7 | 3 | 1 | 12 | \$ 6.06 |

**12" METAL
MÉTAL, 12 PO**



**16" X-LARGE METAL
EXTRA GRAND EN MÉTAL, 16 PO**



LITTER SCOOP WITH HEAVY DUTY BAG ANT

- Heavy duty with light weight frame for picking up debris
- Strong durable bag

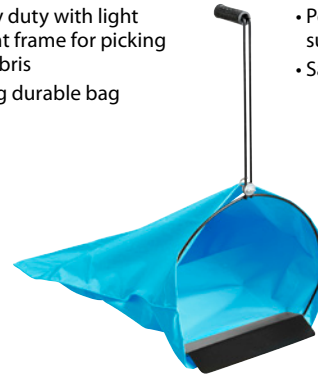

PELLE À LITIÈRE AVEC SAC TRÈS RÉSISTANT

- Pelle à litière très résistante avec support léger
- Sac solide et durable



LITTER PICK-UPS / PINCE À DÉCHETS



| M2 Code Code M2 | Description | Pack Wt LB (S) Poids (lb) (S) | Pack Wt KG Poids (kg) | Cubic Ft Pi3 | Pack Contenu | List Price Liste des prix |
|--------------------|--|----------------------------------|--------------------------|-----------------|-----------------|------------------------------|
| DP-H715 | 12" Metal Dustpan – Black / Porte-poussière en métal, 12 po, noir | 15 | 7 | 1 | 12 | \$ 10.81 |
| DP-H716 | 16" Metal Dustpan – Black / Porte-poussière en métal, 16 po, noir | 15 | 7 | 1 | 12 | \$ 15.71 |
| LS-1171 | Litter Scoop Complete with Heavy Duty Bag / Pelle à litière avec sac très résistant | 3 | 1.5 | | 1 | \$ 47.44 |
| LS-1172 | Litter Scoop – Bag Only / Sac pour pelle à litière | 1.1 | 5 | | 1 | \$ 19.37 |
| LS-1173 | Litter Scoop Frame Only / Cadre pour pelle à litière seulement | 3 | 1.3 | | 1 | \$ 31.94 |
| LS-2100 | Litter Picker-40"/100cm / Pique-ordures-40"/100cm | 3 | 1.5 | | 10/1 | \$ 68.79 |
| WS-LS9537 | Litter Spike - Aluminum Handle - 37.4" / 95cm / Pic à litière poignée en Aluminium - 37.4" / 95 cm | 3 | 1.5 | | 10/1 | \$ 26.57 |

PROFESSIONAL – MAGNETIC BROOMS - JUPITER - FLAT BLOCK BALAIS MAGNÉTIQUES PROFESSIONNEL - JUPITER - BLOC PLAT

JUPITER- KITCHEN BROOM /

- Jupiter Large elegant style upright broom is heavily filled for sweeping fine particles on smooth hardwood floors. Includes a choice of 48" handles.
- Flat block to give more surface cleaning

BALAI DE CUISINE - JUPITER

- Le large et élégant balai droit Jupiter est très rempli pour ramasser les fines particules sur les surfaces lisses des planchers de bois. Comprend un choix de 48 po poignées.
- Bloc plat pour donner plus de nettoyage de surface



| M2 Code Code M2 | Description | Pack Wt LB (S) Poids (lb) (S) | Pack Wt KG Poids (kg) | Cubic Ft Pi3 | Pack Contenu | List Price Liste des prix |
|--------------------|--|----------------------------------|--------------------------|-----------------|-----------------|------------------------------|
| BM-4400 | Jupiter Premium Large Indoor Flat Mag Broom with 48" Metal Handle - Blue / Balai Jupiter premium avec manche en métal 48" - bleu | | | | 10 | \$ 15.42 |
| BM-4400BK | Jupiter Premium Large Indoor Flat Mag Broom with 48" Metal Handle - Black / Balai Jupiter premium avec manche en métal 48" - noir | | | | 10 | \$ 15.42 |
| BM-4420 | Jupiter Premium Lrg Indoor Flat Mag Broom with 48" Wood Handle - Blue / Balai Jupiter premium avec manche en bois 48" - bleu | | | | 10 | \$ 18.64 |



| M2 Code Code M2 | Description | Pack Wt LB (S) Poids (lb) (S) | Pack Wt KG Poids (kg) | Cubic Ft Pi3 | Pack Contenu | List Price Liste des prix |
|--------------------|--|----------------------------------|--------------------------|-----------------|-----------------|------------------------------|
| BM-4410 | Jupiter Premium Large Indoor Flat Mag Broom with Heavy Duty 48" Metal Handle - Blue / Balai Jupiter premium avec manche en métal 48" - bleu | | | | 10 | \$ 21.21 |
| BM-4400-HO | Jupiter Premium Large Indoor Flat Mag Broom - Head Only - Blue / Balai Jupiter premium - tête seulement- bleu | | | | 24 | \$ 13.18 |
| BM-4400-HO-RD | Jupiter Premium Large Indoor Flat Mag Broom - Head Only - Red / Balai Jupiter premium - tête seulement- rouge | | | | 24 | \$ 13.18 |
| BM-4500-HO-BK | Jupiter Premium Large Indoor Flat Mag Broom - Head Only - Black / Balai Jupiter premium - tête seulement - noir | | | | 24 | \$ 13.18 |

KITCHEN – MAGNETIC BROOMS / - VENUS BALAIS MAGNÉTIQUES DE CUISINE - VENUS

VENUS - LARGE CURVED

• Flagged bristles are ideal for fine sweeping fine particles of dirt on smooth surfaces indoors

VENUS – GRANDE COURBE

• Les soies fleurées sont idéales pour balayer les fines particules de salissures sur les surfaces intérieures lisses



BM-4200-RD



BM-4200-BL



BM-4200-W

| M2 Code Code M2 | Description | Pack Wt LB (S) Poids (lb) (S) | Pack Wt KG Poids (kg) | Cubic Ft Pi3 | Pack Contenu | List Price Liste des prix |
|--------------------|---|----------------------------------|--------------------------|-----------------|-----------------|------------------------------|
| BM-4200-RD | Venus – Large Indoor Curved Magnetic Broom with 48” White metal Handle-Red Grand balai-brosse intérieur magnétique Venus, grande courbe, manche de métal blanc 48 po- Etui Mixte - rouge | 8.4 | 3.8 | 1.1 | 10 | \$ 11.17 |
| BM-4200-BL | Venus – Large Indoor Curved Magnetic Broom with 48” White metal Handle - Blue Grand balai-brosse intérieur magnétique Venus, grande courbe, manche de métal blanc 48 po- Etui Mixte - bleu | 8.4 | 3.8 | 1.1 | 10 | \$ 11.17 |
| BM-4200-W | Venus –Large Indoor Magnetic Broom with 48” Wood Handle / Venus - grand, intérieur balai magnétique avec manche en bois 48” | 8.4 | 3.8 | 1.1 | 10 | \$ 15.16 |



BM-4250-BK



BM-4250-BL



BM-4250-RD

Tall Boy / Grand



BM-4260

Stiff Sweep / Balayage robuste



BM-4270

| M2 Code Code M2 | Description | Pack Wt LB (S) Poids (lb) (S) | Pack Wt KG Poids (kg) | Cubic Ft Pi3 | Pack Contenu | List Price Liste des prix |
|--------------------|---|----------------------------------|--------------------------|-----------------|-----------------|------------------------------|
| BM-4250-BK | Venus – Large Indoor Curved Magnetic Broom – Head Only - Black / Grand balai-brosse intérieur magnétique Venus, grande courbe, tête seulement - noir | 8.4 | 3.8 | 1.1 | 24 | \$ 9.51 |
| BM-4250-BL | Venus – Large Indoor Curved Magnetic Broom – Head Only - Blue / Grand balai-brosse intérieur magnétique Venus, grande courbe, tête seulement - bleu | 8.4 | 3.8 | 1.1 | 24 | \$ 9.51 |
| BM-4250-RD | Venus – Large Indoor Curved Magnetic Broom – Head Only - Red / Grand balai-brosse intérieur magnétique Venus, grande courbe, tête seulement - rouge | 8.4 | 3.8 | 1.1 | 24 | \$ 9.51 |
| BM-4260 | Venus –Tall Boy Indoor/Outdoor Magnetic Broom with 48” White Metal Handle / Venus - grand, Intérieur/extérieur balai magnétique avec manche blanc 48” en métal | 7.4 | 4.2 | 1.1 | 6 | \$ 12.91 |
| BM-4260-HO | Venus –Tall Boy Indoor/Outdoor Magnetic Broom - Head Only / Venus - grand, Intérieur/extérieur balai magnétique - tête seulement | 7.4 | 4.2 | 1.1 | 16 | \$ 11.25 |
| BM-4261 | Venus –Tall Boy Indoor/Outdoor Magnetic Broom with 48” Wood Handle / Venus - grand, Intérieur/extérieur balai magnétique avec manche en bois 48” | 7.4 | 4.2 | 1.1 | 6 | \$ 16.28 |
| BM-4270 | Venus Stiff Magnetic Broom with 48” White Metal Handle / Grand balai-brosse intérieur magnétique Venus, grande courbe, manche de 48 po -très raide | 8.3 | 3.8 | 1 | 12 | \$ 11.51 |

KITCHEN – MAGNETIC BROOMS - PLUTO & PROMO - FLAT BLOCK BALAIS MAGNÉTIQUES DE CUISINE - PLUTO ET PROMO - BLOC PLAT



BM-4300-BL



BM-4300-RD



BM-4320-BL-W

| M2 Code Code M2 | Description | Pack Wt LB (S) Poids (lb) (S) | Pack Wt KG Poids (kg) | Cubic Ft Pi3 | Pack Contenu | List Price Liste des prix |
|--------------------|---|----------------------------------|--------------------------|-----------------|-----------------|------------------------------|
| BM-4300-BL | Pluto - Large indoor flat magnetic broom with 48” White metal handle /Grand balai-brosse intérieur magnétique Pluto, avec manche de métal blanc 48 po | | | | 10 | \$ 12.84 |
| BM-4300-RD | Pluto - Large indoor flat magnetic broom with 48” White metal handle /Grand balai-brosse intérieur magnétique Pluto, avec manche de métal blanc 48 po | | | | 10 | \$ 12.84 |
| BM-4320 | Pluto - Large indoor flat magnetic broom with 48” Wood handle /Grand balai-brosse intérieur magnétique Pluto, avec manche en bois 48” | 8 | 3.6 | .8 | 10 | \$ 15.10 |

KITCHEN MAGNETIC BROOMS / BALAIS MAGNÉTIQUES DE CUISINE

SATURN SCRUBBING BROOM /

- Saturn Premium Scrubbing brush has stiff fiber to aggressively scrub floor tile and grout

BALAIS POUR RÉCURAGE SATURN

- La brosse à récurer Saturn premium a des fibres raides pour nettoyer agressivement le carrelage et le coulis,

CUPID - FLAT

- Flagged bristles are ideal for fine sweeping fine particles of dirt on smooth surfaces indoors

CUPID - PLAT

- Les poils marqués sont idéals pour balayer les fines particules de salissures sur les surfaces intérieures lisses



| M2 Code Code M2 | Description | Pack Wt LB (S) Poids (lb) (S) | Pack Wt KG Poids (kg) | Cubic Ft Pi3 | Pack Contenu | List Price Liste des prix |
|--------------------|--|----------------------------------|--------------------------|-----------------|-----------------|------------------------------|
| BM-4500 | Saturn 12" Marine Deck Scrubbing Brush White Short Stiff Fibers with 48" Metal Handle Saturn brosse a récurer pour plancher 12 pouces avec poil white rigide court rouge et blanc/manche 48 pouces en metal | | | | 12 | \$ 16.71 |
| BM-4500-BL | Saturn 12" Marine Deck Scrubbing Brush Bluee Short Stiff Fibers with 48" Metal Handle Saturn brosse a récurer pour plancher 12 pouces avec poil bleu rigide court rouge et blanc/manche 48 pouces en metal | | | | 10 | \$ 16.71 |
| BM-4100 | Cupid Flat Indoor Magnetic Broom with 48" Handle / Balai-brosse intérieur Cupid, plat, manche de 48 po | 8.5 | 4 | 1 | 24 | \$ 6.74 |
| BM-4600-BL | Promo Indoor Magnetic Broom - Blue/Blue & Black with 48" Metal Handle / | | | | 10 | \$ 9.57 |

RIGHT ANGLE – MAGNETIC BROOMS / - VORTEX BALAIS MAGNÉTIQUES ANDLE DROIT - VORTEX

VORTEX KITCHEN / OFFICE ANGLE BROOM

- Ideal for indoor/outdoor clean-up
- Angled design helps to sweep in corners or along walls
- Not affected by water

BALAI EN ANGLE DE CUISINE ET DE BUREAU VORTEX

- Idéal pour le ménage intérieur et extérieur
- Permet de nettoyer facilement le long des murs et dans les coins en raison de la conception de son angle
- Résistant à l'eau

VORTEX ANGLE - HEAVY DUTY – STIFF FIBER / BALAI EN ANGLE VORTEX, FIBRES RAIDES

Soft Sweep / balayage doux

VORTEX ANGLE BROOM / BALAI EN ANGLE VORTEX

Vortex angle long fibre
Angle vortex fibres longues

Stiff Sweep /
Balayage robuste



| M2 Code Code M2 | Description | Pack Wt LB (S) Poids (lb) (S) | Pack Wt KG Poids (kg) | Cubic Ft Pi3 | Pack Contenu | List Price Liste des prix |
|--------------------|---|----------------------------------|--------------------------|-----------------|-----------------|------------------------------|
| BA-3200 | 12" /30cm Vortex Angle Broom short fiber with 48" / 121 cm Handle - Red Block - Black Bristles 12" /30cm Balai en angle Vortex, manche de 48 po / 121 cm | 13.6 | 6 | | 12 | \$ 9.16 |
| BA-3200-1W | 12" /30cm Vortex Angle Broom short fiber with 48" / 121 cm Wood Handle - Baby Blue - Grey Bristles 12" /30cm Balai en angle Vortex, manche de 48 po / 121 cm | 13.6 | 6 | | 12 | \$ 14.31 |
| BA-3220 | 12" /30cm Vortex Angle Broom with 48" / 121 cm Handle – Long Fibre 12" /30cm Balai en angle Vortex, manche de 48 po / 121 cm, fibres longues | 13.6 | 6.4 | 1 | 10 | \$ 11.80 |
| BA-3250 | 12" /30cm Vortex Angle Broom with 48" Heavy Duty Handle / 121 cm Handle – Stiff/Long Fiber / 12" /30cm Balai en angle Vortex, avec manche très résistant de 48 po / 121 cm, fibres raides / fibres longues | 17 | 7.6 | | 6 | \$ 197.50 |
| BA-3250-2 | 12" /30cm Vortex Heavy Duty Angle Broom with 7/8" - 48" Black Handle / 121 cm / 12" /30cm Balai en angle Vortex, avec manche très résistant de 7/8" 48 po / 121 cm, noir | 17 | 7.6 | | 12 | \$ 13.10 |



MAGNETIC ANGLE BROOMS / BALAIS MAGNÉTIQUES EN ANGLE

SMALL ANGLE

- Ideal for indoor/outdoor clean-up
- Angled design helps to sweep in corners or along walls
- Not affected by water

PETIT BALAI EN ANGLE

- Idéal pour le ménage intérieur et extérieur
- Permet de nettoyer facilement le long des murs et dans les coins en raison de la conception de son angle • Résistant à l'eau

LARGE ANGLE BROOM

- Ideal for indoor/outdoor clean-up
- Large angled design helps to sweep in corners or along walls
- Not affected by water

GRAND BALAI EN ANGLE

- Idéal pour le ménage intérieur et extérieur
- Permet de nettoyer facilement le long des murs et dans les coins en raison de la largeur de son angle • Résistant à l'eau



| M2 Code Code M2 | Description | Pack Wt LB (S) Poids (lb) (S) | Pack Wt KG Poids (kg) | Cubic Ft Pi3 | Pack Contenu | List Price Liste des prix |
|--------------------|--|----------------------------------|--------------------------|-----------------|-----------------|------------------------------|
| BA-9900 | 9"/23 cm Mars Small Angle Broom with 48"/121 cm Handle / Petit Mars balai en angle, 9 po / 23 cm, manche métallique de 48 po / 121 cm | 8.5 | 4 | .8 | 24 | \$ 9.38 |
| BA-3036 | 9"/23 cm Mars Small Angle Broom with 36"/91 cm Handle / Balai en angle, 9 po / 23 cm, manche de 36 po / 91 cm | 30 | 13.5 | 1.5 | 12/24 | \$ 8.01 |
| BA-3036-HO | 9"/23 cm Mars Small Angle Broom - Head Only / Balai Mars en angle, 9 po / 23 cm | 30 | 13.5 | 1.5 | 48 | \$ 7.44 |
| BA-9708 | 9"/23 cm Mars Angle Broom Blue/Black with 48" Handle | | | | 12 | \$ 7.30 |
| BA-9708-RD | 10"/25 cm Mars Angle Broom Red/Black with 48" Handle | | | | 12 | \$ 7.30 |
| BA-9708-HO | 10"/25 cm Mars Angle Broom Blue/Black - Head Only | | | | 12 | \$ 5.69 |
| BA-9700 | 10"/25 cm Mars Angle Broom Blue/Black with 48" Handle | | | | 12 | \$ 9.82 |
| BA-9700-RD | 10"/25 cm Mars Angle Broom Red/Black with 48" Handle | | | | 12 | \$ 9.82 |
| BA-9700-HO | 10"/25 cm Mars Angle Broom Blue/Black - Head Only | | | | 12 | \$ 7.86 |
| BA-9800 | 13"/33 cm Large Angle Broom with 48" Handle / | | | | 12 | \$ 14.30 |

ANGLE BROOM & DUSTPAN COMBO / ENSEMBLE DE BALAI EN ANGLE ET PORTE-POUSSIÈRE

MARS – 10" small angle broom with
10" clip-on dustpan
Balai en angle Mars
10" et porte-poussière clip-on 10"

MARS – 12" Medium angle broom
with 13" clip-on dustpan
Balai en angle Mars
12" et porte-poussière clip-on 13"



| | | | | | | |
|-----------|--|--|--|--|----|----------|
| BA-9708-D | 10" / 25 cm Small Mars Angle Broom with 48"/121 cm Handle and 10" / 25 cm Clip-On dust Pan – Blue/Black / Balai 10 po / 25 cm moyen en angle Mars bleu et noir avec manche 48 po / 121 cm et porte-poussière clippé | | | | 12 | \$ 17.05 |
| BA-9700-D | 12" Medium Mars Angle Broom with 48"/121 cm Handle and 13"/33 cm Clip-On dust Pan – Blue/Black / Balai 12" / 30 cm moyen en angle Mars bleu et noir avec manche 48 po / 121 cm et porte-poussière clippé | | | | 12 | \$ 18.18 |

HERCULES – OUR NEWEST HEAVY DUTY INDUSTRIAL BROOM / HERCULES, LE DERNIER NÉ DE NOS BALAIS INDUSTRIELS EXTRA ROBUSTES

INDOOR / OUTDOOR MAGNETIC BROOM

- Ideal for indoor/outdoor clean-up
- Easy to clean
- Not affected by water

BALAI MAGNÉTIQUE INTÉRIEUR / EXTÉRIEUR

- Idéal pour le ménage intérieur et extérieur
- Facile à nettoyer
- Résistant à l'eau

9" / 22.8 CM DuoAngle Thread Broom / Balai fileté deux angles 9" / 22.8 cm

- Converts right angle broom into an upright
- Convertit le balai à angle droit en un montant

NEW SIZE / NOUVELLE TAILLE



10" / 25 cm Block /
Bloc 10"/25 cm



Dustpan with rubber edge /
Ramasse-poussière avec
rebord en caoutchouc



COLOUR CODE
SYSTEM
SYSTÈME
DE CODE
DE COULEUR

BA-8306BK-48

| M2 Code Code M2 | Description | Pack Wt LB (S) Poids (lb) (S) | Pack Wt KG Poids (kg) | Cubic Ft Pi3 | Pack Contenu | List Price Liste des prix |
|--------------------|---|----------------------------------|--------------------------|-----------------|-----------------|------------------------------|
| BA-3000 | 16"/40.5 cm Large Hercules Industrial Angle Broom / Grand balai industriel en angle - Hercules, 16 po/40.5 cm | 12 | 5.5 | 2 | 6 | \$ 20.96 |
| BA-3001 | 16"/40.5 cm Large Industrial Angle Broom including Dustpan / Grand balai industriel en angle, 14 po/36 cm, avec ramasse-poussière | 15 | 7 | 3 | 4 | \$ 24.74 |
| BA-8306-BK | 9" / 22.8 cm Large Angled Broom - DuoAngle Thread - Block Only - Black / 9" / 22.8 cm Large balai en angle - deux angles fileté, bloc seulement - noir | | | | 12 | \$ 15.34 |
| BA-8306-GN | 9" / 22.8 cm Large Angled Broom - DuoAngle Thread - Block Only - Green / 9" / 22.8 cm Large balai en angle - deux angles fileté, bloc seulement - vert | | | | 12 | \$ 15.34 |
| BA-8306-BL | 9" / 22.8 cm Large Angled Broom - DuoAngle Thread - Block Only - Blue / 9" / 22.8 cm Large balai en angle - deux angles fileté, bloc seulement - bleu | | | | 12 | \$ 15.34 |
| BA-8306-RD | 9" / 22.8 cm Large Angled Broom - DuoAngle Thread - Block Only - Red / 9" / 22.8 cm Large balai en angle - deux angles fileté, bloc seulement - rouge | | | | 12 | \$ 15.34 |
| BA-8306-YE | 9" / 22.8 cm Large Angled Broom - DuoAngle Thread - Block Only - Yellow / 9" / 22.8 cm Large balai en angle - deux angles fileté, bloc seulement - jaune | | | | 12 | \$ 15.34 |
| BA-8306BK-48 | 9" / 22.8 cm Large Angled Broom - DuoAngle Thread with 48" Metal Handle - Black / 9" / 22.8 cm Large balai en angle - deux angles fileté, bloc seulement - noir | | | | 6 | \$ 18.73 |

TRACK & SWITCH BROOM / BALAI FERROVIAIRE



PREVENT WINTER HAZARDS WITH M2'S TRACK & SWITCH BROOM

PRÉVENIR LES RISQUES DE L'HIVER AVEC LE BALAI FERROVIAIRE M2

Ideal for ice build-up, road and rail maintenance
and construction

Idéal pour l'accumulation de glace, l'entretien et
la construction de route et de rail



NO CHISEL
PAS DE CISEAU



| | | | | | | |
|-----------|--|------|-----|-----|-----|-----------|
| BT-112 | Track/Switch Industrial Broom with Heavy Duty Forged Chisel / Balai ferroviaire en polypropylène garni de fibres rigides brunes avec large ciseau de métal forgé | 17.2 | 7.8 | 1.9 | 6/1 | \$ 55.411 |
| BT-112-NC | Track/Switch Industrial Broom - No Chisel / Balai ferroviaire industriel/ sans ciseau | 17.2 | 7.8 | 1.9 | 6/1 | \$ 72.20 |
| BT-113 | Industrial Broom with 48" Handle - Stiff Flagged Fibers - Yellow / Balai ferroviaire industriel - jaune | 12.1 | 5.5 | 1.9 | 6/1 | \$ 36.44 |
| BT-115 | Industrial Fire Broom with 48" Stiff Palmira Fibers / | 12.1 | 5.5 | 1.9 | 6 | \$ 56.16 |



CORN BROOMS / BALAIS DE MAÏS

Our corn brooms are sized according to use.

From our light duty household brooms that contain mixed fibers and lighter handles to our extra strong broom designed for outdoor use which contains additional corn and cane fiber with thicker and stronger handle

Nos balais de maïs sont dimensionnés en fonction de l'utilisation.

De nos balais ménagers légers aux fibres moins nombreuses et au manche léger à nos balais d'extérieur super robustes avec des fibres de maïs et de canne supplémentaires et un manche épais et résistant.

WHISK & LOBBY BROOM
PETIT BALAI ET BALAI
D'ENTRÉE



| M2 Code Code M2 | Description | Pack Wt LB (S) Poids (lb) (S) | Pack Wt KG Poids (kg) | Cubic Ft Pi3 | Pack Contenu | List Price Liste des prix |
|--------------------|---|----------------------------------|--------------------------|-----------------|-----------------|------------------------------|
| BC-102 | Heavy duty Corn Whisk 3 String w/Metal cap / Petit balai robuste, 3 cordes, avec embout métallique | 4.2 | 2 | 4 | 12 | \$ 7.32 |
| BC-103 | Lobby Corn Broom / Balai maïs d'entrée | 8.5 | 4 | 1.4 | 12 | \$ 8.61 |

LIGHT DUTY INDOOR USE

POUR TRAVAUX LÉGERS UTILISATION INTÉRIEURE



| | | | | | | |
|--------|---|------|-----|-----|----|----------|
| BC-104 | Indoor/Outdoor 5 String / Extérieur / intérieur, 5 cordes | 16.5 | 7.5 | 3.5 | 12 | \$ 13.15 |
| BC-107 | Indoor/Outdoor 6 String / Extérieur / intérieur, 6 cordes | 19.5 | 9 | 4.3 | 12 | \$ 17.40 |

MEDIUM TO HEAVY INDOOR / OUTDOOR USE /

POUR TRAVAUX MOYENS À LOURDS UTILISATION INTÉRIEURE ET EXTÉRIEURE



| | | | | | | |
|---------|---|------|------|-----|----|----------|
| BC-500 | Medium to Heavy duty 4 String 1 Wire band / Balai moyen à lourd, 4 cordes, 1 bague métallique | 26.5 | 12 | 4.5 | 12 | \$ 16.51 |
| BC-107C | Medium to Heavy duty 3 String 1 Wire band / Balai moyen à lourd, 3 cordes, 1 bague métallique | 22.7 | 10 | 4.5 | 12 | \$ 18.56 |
| BC-108 | Medium to Heavy duty 2 String 2 Wire band / Balai moyen à lourd, 2 cordes, 2 bagues métalliques | 23 | 10.5 | 4.5 | 12 | \$ 20.03 |

HEAVY DUTY - EXTRA STRONG OUTDOOR USE - STIFF SWEEP

EXTRA ROBUSTE UTILISATION EXTÉRIEURE



PLASTIC HOUSEHOLD CORN BROOM



| | | | | | | |
|--------|---|------|----|-----|----|----------|
| BC-110 | Heavy duty stiff 1 String 3 Wire band W/Cane / Balai robuste avec fibres de canne, 1 corde, 3 bagues métalliques | 26.6 | 12 | 5.5 | 12 | \$ 22.27 |
| BC-101 | Plastic Household Corn Broom - Head Only - Takes Threaded Handle | | | | | \$ 19.82 |

DECK BRUSHES / BROSSES DE PONT

CARPET BRUSH BROSSE À TAPIS

- A small natural fiber deck/carpet brush for application of shampoo and pre-spray on rugs and delicate fibres
- Petite brosse de pont / à tapis en fibres naturelles pour l'application de shampooing et la pré-vaporisation des tapis et des fibres délicates



CARPET BRUSH - POLY STIFF FIBER BROSSE A TAPIS-FIBRE RIGIDE EN POLY

Refer to Page 63
for Threaded and Tapered Handles

Se référer à la page 63 pour les manches
filetés et effilés



UTILITY DECK SCRUB - NATURAL FIBER - SOFT SCRUB BROSSES DE PONT GARNIE DE FIBRES NATURELLES - BROSSAGE DOUX

- 11"/30 cm utility scrub with heavy duty squeegee which allows for quick water removal
- Brosse de pont de 11 po/30 cm avec un racloir robuste pour enlever rapidement l'eau



| M2 Code Code M2 | Description | Pack Wt LB (S) Poids (lb) (S) | Pack Wt KG Poids (kg) | Cubic Ft Pi3 | Pack Contenu | List Price Liste des prix |
|--------------------|---|----------------------------------|--------------------------|-----------------|-----------------|------------------------------|
| BCA-228WT | 8"/20 cm Carpet Brush Wood Block – White Natural Fiber / Brosse à tapis de 8 po/20 cm garnie de fibres naturelles blanches, bloc en bois | 12 | 5 | .5 | 12 | \$ 7.07 |
| BCA-228P | 8"/20 cm Carpet Brush Wood Block – Poly Stiff Fiber / Brosse à tapis de 8 po/20 cm | 12 | 5 | .5 | 12 | \$ 6.64 |
| BCA-226WT | 11"/30 cm Utility Deck Scrub & Squeegee – White Natural Fiber / Brosse de pont de 11 po/30 cm garnie de fibres naturelles blanches et racloir | 12 | 5 | .5 | 20 | \$ 9.99 |

UTILITY DECK SCRUB - WHITE POLYPRO BROSSE DE PONT GARNIE DE FIBRES DE POLYPROPYLENE BLANC

- 11"/30 cm utility scrub with heavy duty squeegee which allows for quick water removal. Acid resistant
- Brosse de pont de 11 po/30 cm avec un racloir robuste pour enlever rapidement l'eau. Résistant aux acides.



Refer to Page 63
for Threaded and Tapered Handles
Se référer à la page 63 pour les manches
filetés et effilés



UTILITY DECK SCRUB - BASSINE FIBER / HEAVY SCRUB BROSSE DE PONT GARNIE DE FIBRES NATURELLES BASSINE - BROSSAGE ROBUSTE

- 11"/30 cm utility scrub with heavy duty squeegee which allows for quick water removal
- Brosse de pont de 11po/30 cm avec un racloir robuste pour enlever rapidement l'eau



| | | | | | | |
|------------|--|----|-----|---|----|----------|
| BD-226PL | 11"/30 cm Utility Deck Scrub & Squeegee – White Poly Fiber / Brosse de pont de 11 po garnie de fibres polyester blanches et racloir | 20 | 9 | 1 | 20 | \$ 11.39 |
| BD-226BA | 11"/30 cm Utility Deck Scrub & Squeegee – Bassine Fiber / Brosse de pont de 11 po/30 cm garnie de fibres naturelles bassine et racloir | 21 | 9.5 | 1 | 20 | \$ 9.60 |
| BD-226BA-2 | 11"/30 cm Utility Deck Scrub without Squeegee – Palmira/Bassine Fiber / Brosse de pont de 11 po/30 cm garnie de fibres naturelles bassine ?????????????? | 21 | 9.5 | 1 | 20 | \$ 9.43 |

HAND SCRUB / BROSSE À MAIN

POINTED SCRUB – NATURAL FIBER / SOFT SCRUB EFFILÉE ET GARNIE DE FIBRES NATURELLES - BROSSAGE DOUX

- 9" pointed hand scrub
- Ideal for scrubbing in small tight areas
- Brosse à main effilée de 9 po
- Idéale pour récurer dans les espaces exigus



POINTED SCRUB – WHITE FIBER / HEAVY SCRUB EFFILÉE ET GARNIE DE FIBRES DE POLYPROPYLENE BLANC - BROSSAGE ROBUSTE

- 9" pointed hand scrub
- Ideal for scrubbing in small tight areas
- Brosse à main effilée de 9 po
- Idéale pour récurer dans les espaces exigus



8" ERGONOMIC GRIP SOFT BRISTLE / 8" BROSSE À POIGNÉE ERGONOMIQUE, POILS DOUX

- Soft fiber Grey 1 3/4 "in length
- Ideal for washing delicate surfaces, cars and crystals
- Douce fibre gris 1 3/4 " de longueur
- Idéal pour le lavage des surfaces délicates, les voitures et les cristaux



| | | | | | | |
|----------|--|---|---|----|----|---------|
| BH-229WT | 9"/22 cm Pointed Hand Scrub – White Natural Fiber / Brosse à main effilée de 9 po garnie de fibres naturelles blanches | 9 | 4 | .6 | 20 | \$ 4.09 |
| BH-229PL | 9"/22 cm Pointed Hand Scrub – White Poly Fiber / Brosse à main effilée de 9 po garnie de fibres de polypropylène blanc | 9 | 4 | .6 | 20 | \$ 4.36 |
| BV-3205 | 8"/20 cm Ergonomic Grip Soft Bristle - White Tampico / 8" Brosse à poignée ergonomique, poils doux - Tampico blanche | | | | 12 | \$ 9.55 |



UTILITY BRUSHES / BROSSES UTILITAIRES

8" SCRUBBING BRUSH STIFF W/THREADED HOLE PLASTIC BLOCK

- 2" long Black Stiff Fiber
- Recommended for general cleaning services and takes a threaded handle

8" Brosse Rigide avec Trou Fileté, Bloc en Plastique

- Fibre rigide noire longueur 2"
- Recommandé pour les services généraux de nettoyage, accepte un manche fileté

8" WHITE TAMPICO SCRUBBING BRUSH WITH THREADED HOLE –

- 2" long White tampico fiber
- Ideal for window washing or applying waterproofing - takes a threaded handle

8" Brosse à Récurer en Fibre Tampico Blanche avec Trou Fileté

- 8" Brosse à récurer en fibre tampico
- 8" Brosse à récurer en fibre tampico blanche avec trou fileté - bloc en plastique



| M2 Code Code M2 | Description | Pack Wt LB (S) Poids (lb) (S) | Pack Wt KG Poids (kg) | Cubic Ft Pi3 | Pack Contenu | List Price Liste des prix |
|--------------------|---|----------------------------------|--------------------------|-----------------|-----------------|------------------------------|
| BD-1508 | 8"/20 cm Scrubbing Brush Stiff with Threaded Hole – Plastic Block / 8"/20 cm Brosse rigide avec trou fileté - bloc en plastique | | | | 16 | \$ 7.42 |
| BD-1508-348W | 8"/20 cm Scrubbing Brush with Threaded Hole – Plastic Block and 48" Wood Handle / 8"/20 cm Brosse à récurer avec trou fileté - bloc en plastique et 48 po | | | | 16 | \$ 1.87 |
| BD-1608 | 8"/20 cm White Tampico Scrubbing Brush with Threaded Hole – Plastic Block / 8"/20 cm Brosse à récurer en fibre Tampico blanche avec trou fileté - bloc en plastique | | | | 16 | \$11.48 |

10" SCRUBBING BRUSH STIFF W/THREADED HOLE PLASTIC BLOCK

- 2" long Red Stiff Fiber
- Recommended for general cleaning services takes a threaded handle

10" Brosse Rigide avec Trou Fileté, Bloc en Plastique

- Fibre rigide noire longueur 2"
- Recommandé pour les services généraux de nettoyage, accepte un manche fileté

10" WHITE TAMPICO SCRUBBING BRUSH WITH THREADED HOLE – PLASTIC BLOCK

- 2" long White tampico fiber
- Ideal for window washing or applying waterproofing - takes a threaded handle

10" Brosse à Récurer en Fibre Tampico Blanche avec Trou Fileté - Bloc en Plastique

- Fibre blanche Tampico longueur 2"
- Idéal pour le lavage des vitres ou applications étanches - accepte un manche fileté



| | | | | | | |
|-------------|---|--|--|--|----|----------|
| BD-1110 | 10" / 25 cm Scrubbing Brush Stiff with Threaded Hole – Plastic Block / 10" Brosse rigide avec trou fileté - bloc en plastique | | | | 12 | \$ 11.38 |
| BD-1110-M54 | 10" / 25 cm Scrubbing Brush with Threaded Hole – Plastic Block and 54" Metal Handle / 10" / 25 cm Brosse à récurer avec trou fileté - bloc en plastique et 54 po | | | | 4 | \$ 18.43 |
| BD-1610 | 10" / 25 cm White tampico Scrubbing Brush with Threaded Hole – Plastic Block / 10" / 25 cm Brosse à récurer en fibre Tampico blanche avec trou fileté - bloc en plastique | | | | 12 | \$14.02 |

BULLDOG POT/RIG/UTILITY - UNION FIBER - CONNECTEUR BULLDOG POUR CHAUDRON/ CASSEROLE/UTILITAIRE – FIBRE UNION



| | | | | | | |
|-------------|---|----|---|-----|------|----------|
| BD-BD1705 | BullDog Bolt Deck Scrub Brush-Union Fiber 2.5w x 9"L /3/4 Thickness block trim length 2.5" (6.3 cm)/ Brosse à récurer les ponts, "BullDog Bolt", fibres union sur bloc 2,5" Larg. x 9" Long. x 3/4" épaisseur, longueur des fibres 2,5 po | 12 | 5 | .5 | 12/2 | \$ 13.20 |
| BD-BD1601 | BullDog Bolt Round scrub brush- Union fiber Block 5-1/4" (13.3 cm) round trim length 2.5" (6.3 cm) / Brosse à récurer ronde, "BullDog Bolt", fibres union sur bloc rond 5 1/4" (13.3 cm), longueur des fibres 2,5 po (6.3 cm) | 10 | 5 | 1.3 | 12 | \$ 16.50 |
| PB-BD700-60 | BullDog Connector and 60"x1/18 (152cm x 3cm) Tapered handle Connecteur Bulldog avec manche 60"x1/18 bout fuselé | | | | 4 | \$ 16.68 |
| BR-TR1253 | Black Tampico Tar Applicator Brush 7"x2.5" X 1.1" Wood Block/Tapered Handle sold separately | | | | 12 | \$ 12.26 |

**10" ACID RESISTANT CAR/TRUCK -
PLASTIC BLOCK /
BROSSE RÉSISTANTE AUX ACIDES / AUTOMOBILE /
CAMION 10 PO.**

- Grey/White flagged fiber
- Resistant to common cleaners, detergent or acids
- Fait de fibres marqués gris et blanche.
- Résiste aux nettoyeurs communs, aux détergents et aux acides.

Brushes accept threaded handle
Refer to Page 63 Les brosses acceptent un manche fileté.
Se référer à la page 63

**8" SCRUBBING BRUSH /
BROSSE 8 PO, POILS VERTS INCLINÉ, BLOC EN PLASTIQUE**

- 8" plastic block with stiff short fibers for scrubbing tough areas
- The Polypro fibers are solvent resistant
- Bloc en plastique de 8" avec des fibres courtes rigides pour brosser les zones difficiles.
- Les fibres polypro sont résistantes aux solvants.



| M2 Code Code M2 | Description | Pack Wt LB (S) Poids (lb) (S) | Pack Wt KG Poids (kg) | Cubic Ft Pi3 | Pack Contenu | List Price Liste des prix |
|--------------------|---|----------------------------------|--------------------------|-----------------|-----------------|------------------------------|
| BV-300AR | 10" Acid Resistant Car/Truck Brush – Plastic Block – Grey/White - Flagged Fill / Brosse automobile / camion résistante aux acides, 10 po, poils inclinés gris / blancs, bloc en plastique | 12 | 5.5 | 2.6 | 10 | \$ 26.13 |
| BV-298WH | 8" Scrubbing Brush - Short Polypro Fiber - White / 8" Brosse à récurer - Fibres courtes blanches | | | | 12 | \$ 25.30 |
| BD-224UN | 7" Masonry Brush Union fiber Tapered hole / | | | | 12 | \$ 14.88 |



| | | | | | | |
|-----------|--|----|---|-----|----|----------|
| BW-205WTR | Window Brushes Plastic Block Round – White Natural Fiber / Brosse à vitres en plastique, fibres naturelles blanches, bloc rond | 10 | 5 | 1.3 | 12 | \$ 22.94 |
| BW-205SFR | Window Brushes Plastic Block Round – Grey Flagged / Brosse à vitres en plastique, poils inclinés gris, bloc rond | 10 | 5 | 1.3 | 12 | \$ 22.20 |
| BB-3615 | Baseboard Corner Brush / | | | | 12 | \$ 45.50 |

**WINDOW/CAR/TRUCK WASH SCRUBS /
BROSSES À VITRES / AUTOMOBILES / CAMIONS**

**8" CAR/TRUCK BRUSH - PLASTIC BLOCK /
BROSSE AUTOMOMILE / CAMION 8 PO**

- White Tampico fiber resistant to solvents and heat
- Ideal for commercial car or truck washes
- Fait de fibre blanche Tampico qui résiste aux solvants et à la chaleur.
- Idéale pour les voitures commerciales ou le nettoyage des camions.

**10" CAR/TRUCK BRUSH - PLASTIC BLOCK /
BROSSE AUTOMOMILE / CAMION 10 PO**

- High density green fiber fill
- Ideal for commercial car or truck washes
- Fait de fibre verte haute densité.
- Idéale pour les voitures commerciales ou pour le nettoyage des camions.

**9" CAR/TRUCK BRUSH - PLASTIC BLOCK /
BROSSE AUTOMOMILE / CAMION 9 PO**

- High density green fiber fill
- Ideal for commercial car or truck washes
- Vinyl bumper protects vehicle finishes
- Fait de fibres vertes de haute densité.
- Idéale pour les voitures commerciales ou le nettoyage des camions.
- Un butoir de vinyle protège le fini du véhicule.



| | | | | | | |
|----------|--|-----|-----|-----|----|----------|
| BW-205WT | 8" (20 cm) Car/Truck Brush – Plastic Block – White Tampico Fill / Brosse automobile / camion, 8 po (20 cm), fibres tampico blanches, bloc en plastique | 8.2 | 3.7 | | 12 | \$ 16.06 |
| BV-300F | 10" (25.4 cm) Car/Truck Brush – Plastic Block – Green Flagged Fill / Brosse automobile / camion, 10 po (25.4 cm), poils verts inclinés, bloc en plastique | 10 | 5.5 | 2.6 | 10 | \$ 25.42 |
| BV-301F | 9" (22.8 cm) Car/Truck Brush – Plastic Block with Bumper – Green Flagged Fill / Brosse automobile / camion, 9 po (22.8 cm), poils verts inclinés, bloc en plastique avec pare choc | 10 | 4.5 | 2.6 | 12 | \$ 18.73 |



BI-LEVEL CAR/TRUCK WASH / BROSE À DEUX NIVEAUX - LAVAGE CAR/CAMION



STIFF / RIGIDE

YELLOW STIFF FIBER FOR MORE AGGRESSIVE SCRUBBING / FAIT DE FIBRES ROBUSTES JAUNES POUR UN BROSSAGE PLUS AGRESSIF.

GREEN DENSILY FILLED FLAGGED TIPS FOR SOFT SURFACES / FAIT DE FIBRE DENSE VERTE À POINTES MARQUÉES POUR LES SURFACES DOUCES.

Our 10" heavy duty Bi-Level Brushes come in three types of bristles which are handy for cleaning all types of surfaces and floors
It features flow through holes that allow water to be dispersed across the entire area of the brush
These brushes are great for washing trucks buses and hard to reach areas

BI-LEVEL SCRUB

SOFT / DOUCE



ACID RESISTANT / RÉSISSANTE AUX ACIDES



GREY/WHITE AND ACID RESTANT FIBER FOR MULTI - PURPOSE CLEANING / FAIT DE FIBRES GRISS ET BLANCHES ET RÉSISSANTE AUX ACIDES, POUR DES NETTOYAGES MULTIPLES.

Notre brosse robuste deux niveaux vient en trois types de poils qui conviennent à toutes les surfaces et planchers.
Elle dispose de 5 trous qui permettent de disperser l'eau sur toute la surface de la brosse.
Cette brosse est idéale pour laver les camions, autobus et les espaces difficiles à atteindre.

| M2 Code Code M2 | Description | Pack Wt LB (S) Poids (lb) (S) | Pack Wt KG Poids (kg) | Cubic Ft Pi3 | Pack Contenu | List Price Liste des prix |
|--------------------|--|----------------------------------|--------------------------|-----------------|-----------------|------------------------------|
| BV-400 | Bi-Level Truck Brush - Yellow - Stiff / Brosse à camion à deux niveaux - jaune - Rigide | 1.6 | .75 | .81 | 12/1 | \$ 33.46 |
| BV-400-WH | Bi-Level Food Service Brush - White - Stiff / | 1.6 | .75 | .81 | 12/1 | \$ 35.08 |
| BV-400-GN | Bi-Level Food Service Brush - Green - Stiff / | 1.6 | .75 | .81 | 12/1 | \$ 35.08 |
| BV-400-BL | Bi-Level Food Service Brush - Blue - Stiff / | 1.6 | .75 | .81 | 12/1 | \$ 35.08 |
| BV-400-RD | Bi-Level Food Service Brush - Red - Stiff / | 1.6 | .75 | .81 | 12/1 | \$ 35.08 |
| BV-400-YE | Bi-Level Food Service Brush - Yellow - Stiff / | 1.6 | .75 | .81 | 12/1 | \$ 35.08 |
| BV-420 | Bi-Level Truck Brush - Green Flagged - Soft / Brosse à camion à deux niveaux - vert - inclinés | 1.6 | .75 | .81 | 1 | \$ 34.80 |
| BV-421 | Bi-Level Truck Brush - Acid Restant / Brosse à camion - Résistante aux acides | 1.6 | .75 | .81 | 1 | \$ 34.80 |

UNIVERSAL SCRUBS & GROUT BRUSH / BROSSES UNIVERSELLE ET BROSSES À COULIS



UNIVERSAL SCRUB / BROSE UNIVERSELLE

- Universal scrub brush allows you to scrub decks, walls and base boards
- Brosse universelle qui permet de brosser les ponts, les murs et les plinthes.

GROUT BRUSH

- Grout brush has a V shape bristle to help clean grout lines on a tiled floor
- Stiff chemical resistant polypro bristles allow for strong scrubbing on floors
- Accepts any acme threaded handle

BROSSE À COULIS

- Cette brosse à coulis a des poils en forme de V qui facilitent le nettoyage des lignes de coulis sur le carrelage.
- Ces poils raides résistants aux produits chimiques permettent un brossage robuste sur le plancher.
- Accepte tous les manches filetés Acme.

| | | | | | | |
|------------|---|------|------|-----|----|----------|
| BR-UT60702 | Universal Scrub - White Polypro Bristles / Brosse universelle Polypro - blanc | 3.90 | 1.77 | .25 | 12 | \$ 19.81 |
| BR-UT60709 | Grout Scrub Brush (Handle not included) / Brosse à coulis (manche non inclus) | 6.68 | 3.03 | .98 | 12 | \$ 12.82 |

GROUT BRUSH WITH SCRAPER / BROSE À COULIS AVEC RACLEUR

7" / 17.7 CM DETAIL BRUSH / BROSE À DÉTAILS

9" / 10.8 CM DETAIL BRUSH / BROSE À DÉTAILS

5" / 12.7 CM ROUND ERGONOMIC HAND SCRUB / BROSE À MAIN RONDE ERGONOMIQUE



| | | | | | | |
|--------------|---|-----|-----|-----|-----|----------|
| FP-HS4500-BL | Grout Brush with Scraper / Brosse à coulis avec racleur | 3.3 | 1.5 | 1.6 | 6 | \$ 23.88 |
| FP-HS4012-BL | 7" / 17.7 cm Detail Brush / 7" / 17.7 cm Brosse à détails | .88 | .40 | .41 | 6 | \$ 7.11 |
| FP-HS4022-BL | 9" / 22.8 cm Detail Brush / 9" / 22.8 cm Brosse à détails | 1.1 | .50 | .46 | 6 | \$ 5.59 |
| FP-HS4332-BL | 5" / 12.7 cm Round Ergonomic Hand Scrub - Blue only - 1 3/4" x 44 mm / 5" / 12.7 cm Brosse à main ronde ergonomique - bleu seulement - 1 3/4" x 44 mm | | | | 6/1 | \$ 18.80 |

COUNTER BRUSHES / BROSSES DE COMPTOIR

PLASTIC BLOCK - GREEN FIBER / BLOC EN PLASTIQUE, FIBRES VERTES

- Ideal for fine dust particles where moisture may be encountered
- Idéale pour les particules de poussières fines, où l'humidité est présente.

WOOD BLOCK - TAMPICO FIBER / BLOC EN BOIS, FIBRES TAMPICO

- High quality counter/bannister brush ideal for cleaning all surfaces
- Brosse de comptoir et de rampe de haute qualité, idéale pour nettoyer toutes les surfaces

WOOD BLOCK HORSEHAIR FIBER / BLOC EN BOIS, CRIN DE CHEVAL

- Ideal for fine dust particles - soft sweeping
- Idéale pour les particules de poussières fines

WOOD BLOCK - SILVER TIP FIBER /

BLOC EN BOIS, EXTRÉMITÉS EFFILÉES COULEUR ARGENT

- High quality counter/bannister brush ideal for cleaning all surfaces
- Brosse de comptoir et de rampe de haute qualité, idéale pour nettoyer toutes les surfaces



| M2 Code Code M2 | Description | Pack Wt LB (S) Poids (lb) (S) | Pack Wt KG Poids (kg) | Cubic Ft Pi3 | Pack Contenu | List Price Liste des prix |
|--------------------|--|----------------------------------|--------------------------|-----------------|-----------------|------------------------------|
| BBC-206GP | Counter Brush - Plastic Block Green Fiber / Brosse de comptoir, bloc en plastique, fibres vertes | 8 | 3.5 | .9 | 12 | \$ 8.87 |
| BBC-206T | Counter Brush - Wood Block Tampico Mix Fiber / Brosse de comptoir, bloc en bois, mélange de fibres tampico | 8 | 3.5 | .6 | 12 | \$ 7.62 |
| BBC-206M | Counter Brush - Wood Block Horsehair Mix Fiber / Brosse de comptoir, bloc en bois, mélange de crin de cheval | 8 | 3.5 | .6 | 12 | \$ 11.03 |
| BBC-206SF | Counter Brush - Wood Block Silver Tip Fiber / Brosse de comptoir, extrémités effilées griss, bloc en bois | 8 | 3.5 | .6 | 12 | \$ 7.04 |

POT/RIG/UTILITY / BROSSES À CASSEROLES / UTILITAIRES

SHORT & LONG HANDLE POLY-PRO

- Poly-pro bristles ideal for scrubbing in the foodservice industry

BROSSES AVEC MANCHE LONG OU COURT

GARNIES DE FIBRES DE POLYPROPYLÈNE

- Brosse à récurer garnie de fibres de polypropylène, idéale dans l'industrie de la restauration

SHORT & LONG HANDLE – BASSINE POT BRUSHES

- These wood handle brushes are filled with heat resistant Bassine fibers.
- Ideal for scrubbing tough surfaces

BROSSES À CASSEROLE À POIGNÉE COURTE OU LONGUE, EN FIBRES NATURELLES BASSINE

- Ces brosse à poignée en bois sont garnies de fibres Bassine thermorésistantes.
- Idéales pour frotter les surfaces dures



Refer to pages
for Food Processing Brushes
Se référer à la page
pour Brosse de traitement des
aliments

BRP-210WHT

BRP-210UNL

| | | | | | | |
|--------------|---|---|---|-----|----|----------|
| BRP-210WS-GF | 9" / 22 cm Short Handle Detail Brush - Green Soft Flagged Fiber / | 5 | 2 | .5 | 12 | \$ 12.91 |
| BRP-210WL-GF | 20" / 50 cm Long Handle Detail Brush - Green Soft Flagged Fiber / | 9 | 4 | 1.2 | 6 | \$ 17.40 |
| BRP-210WS | 9" / 22 cm Short Handle Pot Brush - White Fiber / Brosse à casserole à poignée courte, fibres blanches | 5 | 2 | .5 | 12 | \$ 11.73 |
| BRP-210WL | 20" / 50 cm Short Handle Pot Brush - White Fiber / Brosse à casserole à poignée longue, fibres blanches | 9 | 4 | 1.2 | 6 | \$ 16.19 |
| BRP-210BFS | 9" / 22 cm Short Handle Pot Brush - Wood Block Bassine Fiber / Brosse à casserole à poignée courte, bloc en bois, fibres naturelles bassine | 5 | 2 | .5 | 12 | \$ 8.62 |
| BRP-210BFL | 20" / 50 cm Long Handle Pot Brush - Wood Block Bassine Fiber / Brosse à casserole à poignée longue, bloc en bois, fibres naturelles bassine | 9 | 4 | 1.2 | 12 | \$ 16.19 |
| BRP-210WHT | 20" / 50 cm Long Handle Pot Brush - Wood Block Tampico Fiber / Brosse à casserole à poignée longue, bloc en bois, fibres naturelles tampico | 9 | 4 | 1.2 | 12 | \$ 17.39 |
| BRP-210UNL | 20" / 50 cm Long Handle Pot Brush 20" (50 cm) - Wood Block Union Fibre / Brosse à manche long 20" (50 cm), bloc de bois, fibres union | 9 | 4 | 1.2 | 12 | \$ 14.50 |



KALSOMINE/WHITEWASH BRUSHES / BROSSES À CHAUX - KALSOMINE

ALSO AVAILBLE IN /
AUSSI DISPONIBLE EN



7" x 3/4"
18 cm x 2 cm
Block/Bloc



7" x 1 1/4"
18 cm x 3 cm
Block/Bloc



7" x 1 3/4"
18 cm x 4.5 cm
Block/Bloc

SOFT /
DOUX



ACID
RESISTANT
RÉSISTANT
D'ACIDE



| M2 Code Code M2 | Description | Pack Wt LB (S) Poids (lb) (S) | Pack Wt KG Poids (kg) | Cubic Ft Pi3 | Pack Contenu | List Price Liste des prix |
|--------------------|--|----------------------------------|--------------------------|-----------------|-----------------|------------------------------|
| BK-KW2027 | 7" Kalsomine/Whitewash Brush - 2 Row, Plastic Block / Kalsomine - Brosse à chaux 7" - 2 rangs, bloc de plastique | 17 | 7.5 | 1.4 | 40/6 | \$ 6.75 |
| BK-KW2028 | 7" Kalsomine/Whitewash Brush - 4 Row, Plastic Block / Kalsomine - Brosse à chaux 7" - 4 rangs, bloc de plastique | 7.5 | 3.4 | 1.4 | 20/6 | \$ 8.62 |
| BK-KW2029 | 7" Kalsomine/Whitewash Brush - 5 Row, Plastic Block / Kalsomine - Brosse à chaux 7" - 5 rangs, bloc de plastique | 7.5 | 3.4 | 1.4 | 20/6 | \$ 11.09 |
| BK-KW2027-GN | 7" Kalsomine/Whitewash Brush With 2 row Plastic Block - Green Fiber Kalsomine - Brosse à chaux 7" - 2 rangs, bloc de plastique - Fibre Vert | 7.5 | 3.4 | 1.4 | 12 | \$ 6.75 |
| BK-KW2027-GY | 7" Kalsomine/Whitewash Brush With 2 row Plastic Block - Grey Fiber Kalsomine - Brosse à chaux 7" - 2 rangs, bloc de plastique - Fibre Gris | 7.5 | 3.4 | 1.4 | 12 | \$ 6.75 |

MASONRY / KALSOMINE / BROSE DE MAÇONNERIE / À CHAUX



- 7" x 1 3/8" / 17cm x 3.5 cm
Wood block high quality
natural fiber
- 4 Rows of 2 3/8" / 4.5 cm
bristles
- Bloc en bois de 7 x 1 3/8 po/
17cm x 3.5 cm, fibres
naturelles de haute qualité
- 4 rangées de fibres de 2 3/8 po
/ 4.5 cm



- 6 1/2" x 2" / 17 x 5 cm Wood block
with longer high quality
natural fiber
- 5 Rows of 4" bristles
- Bloc en bois de
6 1/2 x 2 po / 17 x 5 cm
avec longues fibres
naturelles de haute qualité
- 5 rangées de fibres de 4 po

| M2 Code Code M2 | Description | Pack Wt LB (S) Poids (lb) (S) | Pack Wt KG Poids (kg) | Cubic Ft Pi3 | Pack Contenu | List Price Liste des prix |
|--------------------|--|----------------------------------|--------------------------|-----------------|-----------------|------------------------------|
| BK-207L | 7" Kalsomine/Whitewash Brush With Wood Block / Brosse de maçonnerie / à chaux, 7 po, avec bloc en bois | 17 | 7.5 | 1.4 | 30/12 | \$ 8.62 |
| BK-397L | 6 1/2" / 16 cm Large Kalsomine/Whitewash Brush With Wood Block / Grande brosse de maçonnerie / à chaux, 6 1/2 po / 16 cm, avec bloc en bois | 7.5 | 3.4 | .9 | 12 | \$ 11.09 |

WIRE BRUSH / BROSSES À FILS D'ACIER

PLASTIC SHORT HANDLE /
POIGNÉE COURTE EN PLASTIQUE



MANCHE LONG ET COURT

- Ces brosses à fils d'acier
sont très pratiques pour
enlever la rouille, nettoyer
les grils de barbecue ou
décaper avant de peindre



LONG & SHORT HANDLE

- These handy wire
brushes are ideal for
removing rust and
debris from barbecue
grills or for scraping
prior to painting



| M2 Code Code M2 | Description | Pack Wt LB (S) Poids (lb) (S) | Pack Wt KG Poids (kg) | Cubic Ft Pi3 | Pack Contenu | List Price Liste des prix |
|--------------------|--|----------------------------------|--------------------------|-----------------|-----------------|------------------------------|
| BW-1037 | Wire Scratch Brushes 3 Row 13" / 33cm / Brosse fils d'acier, 3 rangées 13" / 33 cm | 7 | 3.1 | | 12 | \$ 5.90 |
| BW-1038 | Shoe Handle Wire Scratch - 4 Rows 10" / 25cm / Brosse fils d'acier, manche long - 4 rangées 10 po / 25 cm | 7 | 3.1 | | 12 | \$ 7.58 |
| BW-1039 | Plastic Handle Wire Scratch - 4 x 17 Rows 12" / 30cm - Black / Brosse à fils à manche de plastique - 4 x 17 rangs 12" / 30 cm noir | | | | 12 | \$ 6.43 |

SPECIALTY BRUSHES / BROSSES SPÉCIALISÉES

DISH & SINK / BROSSSE POUR LA VAISSELLE ET L'ÉVIER

- Ergonomically designed handle is great for cleaning dishes, bowls plates and cups
- Two-sided brush for scrubbing stiff caked on dirt
- Long lasting bristles
- Manche ergonomique idéal pour laver la vaisselle
- Fibres des deux côtés pour éliminer les saletés incrustées
- Fibres durables



HAND HELD SCRUB / BROSSSE À MAIN

- Stiff fibers for cleaning tile grout with stubborn stain
- Fibre raide pour nettoyer les lignes de coulis qui ont des taches tenaces.



| M2 Code Code M2 | Description | Pack Wt LB (S) Poids (lb) (S) | Pack Wt KG Poids (kg) | Cubic Ft Pi3 | Pack Contenu | List Price Liste des prix |
|--------------------|---|----------------------------------|--------------------------|-----------------|-----------------|------------------------------|
| BR-UT1020 | Dish & Sink Brush / Brosse pour la vaisselle et l'évier | 3 | 1.5 | .4 | 12 | \$ 4.20 |
| BR-UT60306 | Hand Held Grout Cleaner / Brosse à main pour coulis | .52 | .24 | .30 | 10/5 | \$ 5.06 |

NAIL & HAND BRUSHES / BROSSES À ONGLES ET À MAINS

6" SCRUB / BROSSSE, 6 PO

- Medium poly-pro fill for scrubbing in most areas
- Handle prevents slipping
- Garnie de fibres en polypropylène moyennes pour nettoyer la plupart des endroits
- Poignée antidérapante



HAND & NAIL / MAINS ET ONGLES

- Soft to medium poly-pro fill for cleaning
- Handle prevents slipping
- Garnie de fibres en polypropylène de douces à moyennes
- Poignée antidérapante



| | | | | | | |
|----------|---|-----|----|----|----|---------|
| BR-SC229 | 6" Scrub with Handle / 6" Brosse avec poignée | 2.3 | 1 | .2 | 6 | \$ 4.52 |
| BR-SC231 | 4.5" x 1.5" Hand and Nail Brush / 4.5" x 1.5" Brosse à main et ongles | 1.8 | .8 | .2 | 12 | \$ 3.24 |

PROFESSIONAL PUTTY KNIVES / COUTEAU À MASTIC PROFESSIONNEL



WS-PT200



WS-PT201



WS-PT202



WS-SC205



WS-SC206

WS-SCR004 / WS-SCR005



FP-PA8502

| | | | |
|-----------|--|------|----------|
| WS-PT200 | 1-1/2 / 3.8 cm Professional Flexible Putty Knife / 1-1/2 / 3.8 cm Couteau à mastic professionnel flexible | 10 | \$ 16.92 |
| WS-PT201 | 1-1/2 / 3.8 cm Professional Stiff Putty Knife / 1-1/2 / 3.8 cm Couteau à mastic professionnel rigide | 5 | \$ 16.92 |
| WS-PT202 | 1-3/16 / 3 cm Professional Flexible Putty Knife / 1-3/16 / 3 cm Couteau à mastic professionnel flexible | 5 | \$ 11.73 |
| WS-SC205 | Economy Safety Scraper 1 1/2" / 3.8 cm / Grattoir de sécurité économique - 1 1/2" / 3.8 cm | 10 | \$ 7.31 |
| WS-SC206 | Plastic Safety Scraper / Grattoir de sécurité en plastique | 10 | \$ 5.41 |
| WS-SCR004 | 0.009" Replacement Razor Scraper Blades for (Pack 5) / 0.009" Lame de remplacement de grattoir (Paq 5) | 5 | \$ 4.13 |
| WS-SCR005 | 0.009" Replacement Razor Scraper Blades for (Pack 100) / 0.009" Lame de remplacement de grattoir (Paq 100) | 5 | \$ 40.67 |
| FP-PA8502 | 9.75" / 25 cm Part Brush Black bristles / Brosse de pièces fibres noires - 9.75" / 25 cm | 12/1 | \$ 11.92 |



TIGER SIDE CLIPPED RETAIL PUSHBROOMS - COMPLETE WITH HANDLES BALAIS-POUSSOIR CLIPPÉS SUR LE CÔTÉ – COMPLETS AVEC MANCHES

M2's All Purpose Pushbrooms can sweep debris ranging from fine dust particles on smooth surfaces, to coarse gravel and dust on rough surfaces. They are designed for indoor and/or outdoor use under wet or dry conditions.

Our High Quality All Purpose Pushbrooms come clipped to the handles and pre-packaged, making them perfect for retail displays.

Les balais-poussoir tous-usages de M2, peuvent balayer des débris allant des fines particules de poussière sur les surfaces lisses, au gravier grossier et à la poussière sur les surfaces rugueuses. Ils sont conçus pour une utilisation intérieurs et/ou extérieure dans des conditions humides ou sèches.

Nos balais-poussoir polyvalents de haute qualité sont clipsés aux manches, pré-emballés, ce qui en fait un produit parfait pour les présentoirs de vente au détail.

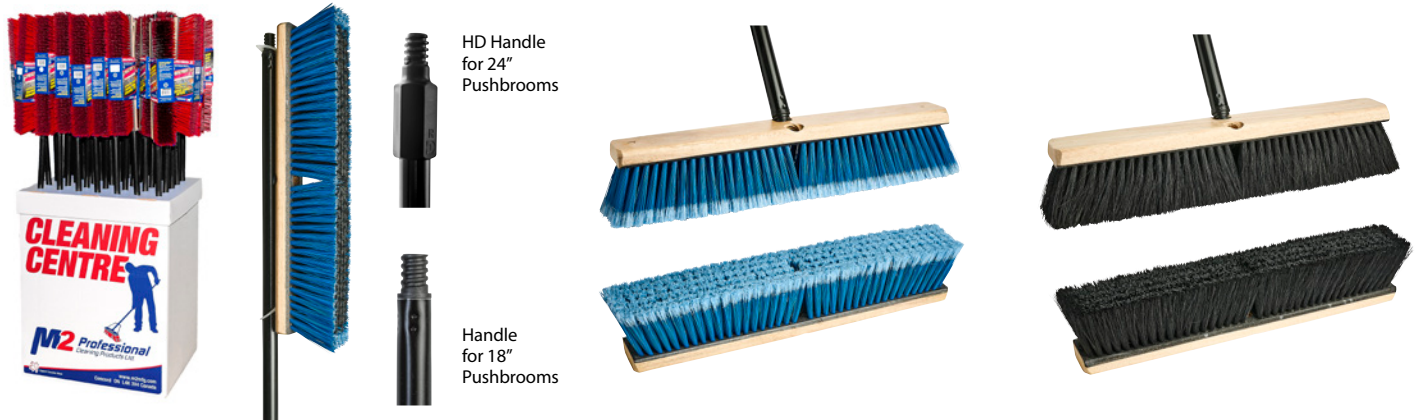

| M2 Code Code M2 | Description | Pack Wt LB (S) Poids (lb) (S) | Pack Wt KG Poids (kg) | Cubic Ft Pi3 | Pack Contenu | List Price Liste des prix |
|--|---|----------------------------------|--------------------------|-----------------|-----------------|------------------------------|
| SIDE CLIPPED FINE FLAGGED TIP BROOM with BLACK METAL HANDLE / | | | | | | |
| PB-600-BT18 | 18" / 45 cm - Side Clipped Fine flagged tip with 54"/137 cm - Black Handle | 18.16 | 8.23 | 3.09 | 6 | \$ 39.51 |
| PB-600-BT24 | 24" / 60 cm - Side Clipped Fine flagged tip with - HD Black Handle – 54"/137 cm | 21.28 | 9.65 | 3.09 | 6 | \$ 46.34 |
| SIDE CLIPPED MEDIUM TAMPICO BROOM with BLACK METAL HANDLE & BRACE / | | | | | | |
| PB-610-T18 | 18" / 45 cm - Side Clipped Medium Tampico with - Black Handle – 54"/137 cm / | 18.16 | 8.23 | 3.09 | 6 | \$ 41.72 |
| PB-610-T24 | 24" / 60 cm - Side Clipped Medium Tampico with - HD Black Handle – 54"/137 cm / | 21.28 | 9.65 | 3.09 | 6 | \$ 49.25 |



| | | | | | | |
|---|--|-------|-------|------|---|----------|
| SIDE CLIPPED MEDIUM BLACK/RED with BLACK METAL HANDLE / | | | | | | |
| PB-540-RB14 | 14"/35 cm Tiger- Black/Red Fiber - Medium with 48"/122 cm - Black Handle | 16.17 | 7.33 | 3.09 | 9 | \$ 21.78 |
| PB-540-RB18 | 18"/45 cm TBlack/Red Fiber - Medium with 54"/137 cm - Black Handle | 18.16 | 8.23 | 3.09 | 6 | \$ 25.72 |
| PB-540-RB24 | 24"/60 cm Black/Red Fiber - Medium with 54"/137 cm - Black Handle | 21.28 | 9.65 | 3.09 | 6 | \$ 29.82 |
| SIDE CLIPPED COURSE GARAGE BROOM with BLACK METAL HANDLE / | | | | | | |
| PB-620-G18 | 18" / 45 cm - Side Clipped Coarse Garage with - Black Handle – 54"/137 cm | 18.16 | 8.23 | 3.09 | 6 | \$ 38.07 |
| PB-620-G24 | 24" / 60 cm - Side Clipped Coarse Garage with HD Black Handle – 54"/137 cm | 21.28 | 9.65 | 3.09 | 6 | \$ 44.37 |
| SIDE CLIPPED COURSE BLUE/BLACK with BLACK METAL HANDLE / | | | | | | |
| PB-630-BB18 | 18" / 45 cm - Side Clipped Medium Blue/Black with - Black Handle – 54"/137 cm | 19.31 | 8.76 | 3.09 | 6 | \$ 31.07 |
| PB-630-BB24 | 24" / 60 cm - Side Clipped Medium Blue/Black with HD Black Handle – 54"/137 cm | 22.42 | 10.17 | 3.09 | 6 | \$ 35.21 |

RYNO RYNO PUSHBROOM COMES COMPLETE WITH BRACE & HEAVY DUTY HANDLE FULLYASSEMBLED BALAI-POUSSOIR RYNO AVEC ENTRETOISE ET MANCHE EXTRA ROBUSTE ENTièrement ASSEMBLÉ



SOFT / DOUX

| M2 Code Code M2 | Description | Pack Wt LB (S) Poids (lb) (S) | Pack Wt KG Poids (kg) | Cubic Ft Pi³ | Pack Contenu | List Price Liste des prix |
|-----------------------|--|----------------------------------|--------------------------|-----------------|-----------------|------------------------------|
| PB-810-BT18 | 18"/45 cm Ryno -Soft PVC Fiber, brace & tapered handle assembled - Blue Ryno, fibre douce, 18/45 cm po, entretoise et manche à bout fuselé, assemblés, bleu | 19 | 9 | 4.7 | 4 | \$ 47.47 |
| PB-810-BT24 | 24"/60 cm Ryno - Soft PVC Fiber, brace & tapered handle assembled - Blue Ryno, fibre douce, 24/60 cm po, entretoise et manche à bout fuselé assemblés, bleu | 23 | 11 | 1.3 | 4 | \$ 54.61 |
| PB-810-BT24 | 24"/60 cm Ryno - Soft PVC Fiber, brace & tapered handle assembled - Blue Ryno, fibre douce, 24/60 cm po, entretoise et manche à bout fuselé assemblés, bleu | 23 | 11 | 1.3 | 4 | \$ 82.61 |
| MEDIUM / MOYEN | | | | | | |
| PB-800-BB18 | 18"/45 cm Ryno - Soft Fiber, brace & tapered handle assembled - Blue Ryno, fibre douce, 18/45 cm po, entretoise et manche à bout fuselé, assemblés, bleu | 19 | 9 | 4.7 | 4 | \$ 46.61 |
| PB-800-BB24 | 24"/60 cm Ryno - Soft Fiber, brace & tapered handle assembled - Blue Ryno, fibre douce, 24/60 cm po, entretoise et manche à bout fuselé assemblés, bleu | 23 | 11 | 1.3 | 4 | \$ 55.32 |
| PB-800-RB18 | 18"/45 cm Ryno - Medium PCV fill with brace & tapered handle assembled - Red / Black / 18"/45 cm Ryno - Remplissage moyen en PCV avec renfort et poignée conique assemblés, rouge / noir | 19 | 9 | 4.7 | 4 | \$ 46.61 |
| PB-800-RB24 | 24"/60 cm Ryno - Medium PCV fill with brace & tapered handle assembled - Red / Black / 24"/60 cm Ryno - Remplissage moyen en PCV avec renfort et poignée conique assemblés, rouge / noir | 23 | 11 | 1.3 | 4 | \$ 55.32 |
| PB-800-RB36 | 36"/90 cm Ryno - Medium PCV fill with brace & tapered handle assembled - Red / Black / 36"/90 cm Ryno - Remplissage moyen en PCV avec renfort et poignée conique assemblés, rouge / noir | | | | 4 | \$ 82.61 |
| PB-800-RB48 | 48"/122 cm Ryno - Medium PCV fill with brace & tapered handle assembled - Red / Black / 48"/122 cm Ryno - Remplissage moyen en PCV avec renfort et poignée conique assemblés, rouge / noir | | | | 1 | \$ 147.35 |



STIFF / RIGIDE

| | | | | | | |
|-------------|--|----|----|-----|---|----------|
| PB-700-GB18 | 18"/45 cm Ryno Stiff - PVC fill, brace & tapered handle - Green /- Assembled Ryno - Rigide, fibres en PVC, 18/45 cm po, entretoise et manche à bout fuselé, vert | 19 | 9 | 7.3 | 4 | \$ 46.62 |
| PB-700-GB24 | 24"/60 cm Ryno Stiff - PVC fill, brace & tapered handle - Green /- Assembled Ryno - Rigide, fibres en PVC, 24/60 cm po, entretoise et manche à bout fuselé, vert - Assemblé | 23 | 11 | 2.9 | 4 | \$ 55.31 |
| PB-700-RB18 | 18"/45 cm Ryno Stiff - PVC fill, brace & tapered handle - Red/Black/- Assembled Ryno - Rigide, fibres en PVC, 18/45 cm po, entretoise et manche à bout fuselé, rouge - Assemblé | 19 | 9 | 4.7 | 4 | \$ 46.61 |
| PB-700-RB24 | 24"/60 cm Ryno Stiff - PVC fill, brace & tapered handle - Red/Black/- Assembled Ryno - Rigide, fibres en PVC, 24/60 cm po, entretoise et manche à bout fuselé, rouge - Assemblé | 23 | 11 | 1.3 | 4 | \$ 55.32 |
| PB-700-RB36 | 36"/90 cm Ryno Stiff - PVC fill, brace & tapered handle - Red/Black/- Assembled Ryno - Rigide, fibres en PVC, 36/90 cm po, entretoise et manche à bout fuselé, rouge/noir - Assemblé | 23 | 11 | 1.3 | 4 | \$ 82.61 |
| PB-700-BB18 | 18"/45 cm Ryno Stiff - PVC fill, brace & tapered handle - Blue/Black/- Assembled Ryno - Rigide, fibres en PVC, 18/45 cm po, entretoise et manche à bout fuselé, bleu/noir - Assemblé | 19 | 9 | 4.7 | 4 | \$ 46.61 |
| PB-700-BB24 | 24"/60 cm Ryno Stiff - PVC fill, brace & tapered handle - Blue/Black/- Assembled Ryno - Rigide, fibres en PVC, 24/60 cm po, entretoise et manche à bout fuselé, bleu/noir - Assemblé | 23 | 11 | 1.3 | 4 | \$ 55.32 |
| PB-700-BB36 | 36"/90 cm Ryno Stiff - PVC fill, brace & tapered handle - Blue/Black/- Assembled Ryno - Rigide, fibres en PVC, 36/90 cm po, entretoise et manche à bout fuselé, bleu/noir - Assemblé | 23 | 11 | 1.3 | 4 | \$ 82.81 |

EXTRA STIFF / EXTRA RIGIDE

| | | | | | | |
|-------------|--|----|----|-----|---|-----------|
| PB-720-OR18 | 18"/45 cm Ryno Extra Stiff - PVC fill, brace & tapered handle - Orange/Black/- Assembled Ryno, Extra Rigide, fibres en PVC, 18/45 cm po, entretoise et manche à bout fuselé, orange/noir - Assemblé | 19 | 9 | 4.7 | 4 | \$ 46.61 |
| PB-720-OR24 | 24"/60 cm Extra Stiff Ryno - PVC fill, brace & tapered handle - Orange/Black/- Assembled Ryno, Extra Rigide fibres en PVC, 24/60 cm po, entretoise et manche à bout fuselé, orange/noir - Assemblé | 23 | 11 | 1.3 | 4 | \$ 55.32 |
| PB-720-OR36 | 36"/90 cm Extra Stiff Ryno - PVC fill, brace & tapered handle - Orange/Black/- Assembled Ryno, Extra Rigide fibres en PVC, 36/90 cm po, entretoise et manche à bout fuselé, orange/noir - Assemblé | 23 | 11 | 1.3 | 4 | \$ 82.61 |
| PB-720-OR48 | 48"/121 cm Extra Stiff Ryno - PVC fill, brace & tapered handle - Orange/Black/- Assembled Ryno, Extra Rigide fibres en PVC, 48/121 cm po, entretoise et manche à bout fuselé, orange/noir - Assemblé | 23 | 11 | 1.3 | 4 | \$ 147.35 |



RYNO UN-ASSEMBLED IN ONE BOX / BALAI RYNO NON-ASSEMBLÉ DANS UNE BOÎTE



| M2 Code Code M2 | Description | Pack Wt LB (S) Poids (lb) (S) | Pack Wt KG Poids (kg) | Cubic Ft Pi3 | Pack Contenu | List Price Liste des prix |
|--------------------|---|----------------------------------|--------------------------|-----------------|-----------------|------------------------------|
| PB-700-GB18-UNA | 18"/45 cm Ryno - PVC Stiff fibre fill, Brace & Tapered Handle - Green/Black - Shipped Un-assembled in One Box Ryno, fibres en PVC rigide, 18/45 cm po, entretoise et manche à bout fuselé, vert/noir - Expédié non assemblé dans une boîte | 19 | 9 | 4.7 | 6 | \$ 42.16 |
| PB-700-GB24-UNA | 24"/60 cm Ryno - PVC Stiff fibre fill, Brace & Tapered Handle - Green/Black - Shipped Un-assembled in One Box Ryno, fibres en PVC rigide, 24/60 cm po, entretoise et manche à bout fuselé, vert/noir - Expédié non assemblé dans une boîte | 23 | 11 | 1.3 | 4 | \$ 50.14 |

BULLDOG BROOM COMPLETE / BALAI BULLDOG COMPLET



| M2 Code Code M2 | Description | Pack Wt LB (S) Poids (lb) (S) | Pack Wt KG Poids (kg) | Cubic Ft Pi3 | Pack Contenu | List Price Liste des prix |
|--------------------|---|----------------------------------|--------------------------|-----------------|-----------------|------------------------------|
| PB-BD700-GB18 | 18"/45 cm Bulldog Stiff Non Flagged Green Outside/Black fill with Bulldog Bracket, Brace, & Tapered Handle - Assembled / 18"/45 cm | | | | 4 | \$ 47.04 |
| PB-BD700-GB24 | 24"/60 cm Bulldog Stiff Non Flagged Green Outside/Black fill with Bulldog Bracket, Brace, & Tapered Handle - Assembled / 24"/60 cm | | | | 4 | \$ 54.76 |
| PB-BD700-GB36 | 36"/90 cm Bulldog Stiff Non Flagged Green Outside/Black fill with Bulldog Bracket, Brace, & Tapered Handle - Assembled / 36"/90 cm | | | | 4 | \$ 87.82 |



| M2 Code Code M2 | Description | Pack Wt LB (S) Poids (lb) (S) | Pack Wt KG Poids (kg) | Cubic Ft Pi3 | Pack Contenu | List Price Liste des prix |
|--------------------|---|----------------------------------|--------------------------|-----------------|-----------------|------------------------------|
| PB-BD900-GB18 | 18"/45 cm Bulldog Medium - Soft Green Outside/Black fill with Bulldog Bracket, Brace, & Tapered Handle - Assembled / 18"/45 cm | | | | 4 | \$ 47.04 |
| PB-BD900-GB24 | 24"/60 cm Bulldog Medium - Soft Green Outside/Black fill with Bulldog Bracket, Brace, & Tapered Handle - Assembled / 24"/60 cm | | | | 4 | \$ 54.76 |
| PB-BD900-GB36 | 36"/90 cm Bulldog Medium - Soft Green Outside/Black fill with Bulldog Bracket, Brace, & Tapered Handle - Assembled / 36"/90 cm | | | | 4 | \$ 87.82 |



| M2 Code Code M2 | Description | Pack Wt LB (S) Poids (lb) (S) | Pack Wt KG Poids (kg) | Cubic Ft Pi3 | Pack Contenu | List Price Liste des prix |
|--------------------|--|----------------------------------|--------------------------|-----------------|-----------------|------------------------------|
| PB-BD800-RB18 | 18"/45 cm Bulldog Medium Red/Black Flagged fill with Bulldog Bracket, Brace, & Tapered Handle - Assembled / 18"/45 cm | | | | 4 | \$ 47.04 |
| PB-BD800-RB24 | 24"/60 cm Bulldog Medium Red/Black Flagged fill with Bulldog Bracket, Brace, & Tapered Handle - Assembled / 24"/60 cm | | | | 4 | \$ 54.76 |
| PB-BD800-RB36 | 36"/90 cm Bulldog Medium Red/Black Flagged fill with Bulldog Bracket, Brace, & Tapered Handle - Assembled / 36"/90 cm | | | | 4 | \$ 87.82 |

BULLDOG HEAD ONLY /TÊTE SEULEMENT



SOFT/ DOUX

| M2 Code Code M2 | Description | Pack Wt LB (S) Poids (lb) (S) | Pack Wt KG Poids (kg) | Cubic Ft Pi3 | Pack Contenu | List Price Liste des prix |
|--------------------|---|----------------------------------|--------------------------|-----------------|-----------------|------------------------------|
| PB-BD801-BT18 | 18"/45 cm Bulldog – PVC Soft fibre fill, Head Only - Blue Bulldog, fibres en PVC doux, 18/45 cm po, Tête seulement, bleu | 19 | 9 | 4.7 | 12 | \$ 26.39 |
| PB-BD801-BT24 | 24"/60 cm Bulldog – PVC Soft fibre fill, Head Only - Blue Bulldog, fibres en PVC doux, 24/60 cm po, Tête seulement, bleu | 23 | 11 | 1.3 | 12 | \$ 36.72 |
| PB-BD801-BT36 | 36"/90 cm Bulldog – PVC Soft fibre fill, Head Only - Blue Bulldog, fibres en PVC doux, 36/90 cm po, Tête seulement, bleu | | | | 6 | \$ 56.40 |



MEDIUM STIFF / MOYEN RIGIDE

| | | | | | | |
|---------------|---|----|----|-----|----|----------|
| PB-BD701-RB18 | 18"/45 cm Bulldog – PVC Medium/Stiff fibre fill, Head Only - Red Bulldog, fibres en PVC moyen/rigide, 18/45 cm po, Tête seulement, rouge | 19 | 9 | 4.7 | 12 | \$ 26.39 |
| PB-BD701-RB24 | 24"/60 cm Bulldog – PVC Medium/Stiff fibre fill, Head Only - Red Bulldog, fibres en PVC moyen/rigide, 24/60 cm po, Tête seulement, rouge | 23 | 11 | 1.3 | 12 | \$ 36.72 |
| PB-BD701-RB36 | 36"/90 cm Bulldog – PVC Medium/Stiff fibre fill, Head Only - Red Bulldog, fibres en PVC moyen/rigide, 36/90 cm po, Tête seulement, rouge | | | | 6 | \$ 56.40 |



STIFF / RIGIDE

| | | | | | | |
|---------------|---|----|----|-----|----|----------|
| PB-BD701-GB18 | 18"/45 cm Bulldog – PVC Medium/Stiff Fibre Fill, Head Only - Green/Black Bulldog, fibres en PVC moyen/rigide, 18/45 cm po, Tête seulement, vert/noir | 19 | 9 | 4.7 | 12 | \$ 26.39 |
| PB-BD701-GB24 | 24"/60 cm Bulldog – PVC Medium/Stiff Fibre Fill, Head Only - Green/Black Bulldog, fibres en PVC moyen/rigide, 24/60 cm po, Tête seulement, vert/noir | 23 | 11 | 1.3 | 12 | \$ 36.72 |
| PB-BD701-GB36 | 36"/90 cm Bulldog – PVC Medium/Stiff Fibre Fill, Head Only - Green/Black Bulldog, fibres en PVC moyen/rigide, 36/90 cm po, Tête seulement, vert/noir | | | | 6 | \$ 56.40 |



RYNO HEAD ONLY /TÊTE SEULEMENT



SOFT/ DOUX

| M2 Code Code M2 | Description | Pack Wt LB (S) Poids (lb) (S) | Pack Wt KG Poids (kg) | Cubic Ft Pi3 | Pack Contenu | List Price Liste des prix |
|--------------------|--|----------------------------------|--------------------------|-----------------|-----------------|------------------------------|
| PB-811--BT18-HO | 18"/45 cm Ryno – PVC Soft fibre fill, Head Only - Blue Ryno, fibres en PVC doux, 18/45 cm po, Tête seulement, bleui | 19 | 9 | 4.7 | 12 | \$ 26.39 |
| PB-811--BT24-HO | 24"/60 cm Ryno – PVC Soft fibre fill, Head Only - Blue Ryno, fibres en PVC doux, 24/60 cm po, Tête seulement, bleu | 23 | 11 | 1.3 | 12 | \$ 36.72 |
| PB-811--BT36-HO | 36"/90 cm Ryno – PVC Soft fibre fill, Head Only - Blue Ryno, fibres en PVC doux, 36/90 cm po, Tête seulement, bleu | | | | 6 | \$ 56.40 |



MEDIUM/MOYEN

| | | | | | | |
|----------------|--|----|----|-----|----|-----------|
| PB-801-RB18-HO | 18"/45 cm Ryno – PVC Medium fibre fill, Head Only - Red/Black Ryno, fibres en PVC doux, 18/45 cm po, Tête seulement, rouge/noir | 19 | 9 | 4.7 | 12 | \$ 26.39 |
| PB-801-RB24-HO | 24"/60 cm Ryno – PVC Medium fibre fill, Head Only - Red/Black Ryno, fibres en PVC doux, 24/60 cm po, Tête seulement, rouge/noir | 23 | 11 | 1.3 | 12 | \$ 36.72 |
| PB-801-RB36-HO | 36"/90 cm Ryno – PVC Medium fibre fill, Head Only - Red/Black Ryno, fibres en PVC doux, 36/90 cm po, Tête seulement, rouge/noir | | | | 6 | \$ 56.40 |
| PB-801-RB48-HO | 48"/122 cm Ryno – PVC Medium fibre fill, Head Only - Red/Black Ryno, fibres en PVC doux, 36/122 cm po, Tête seulement, rouge/noir | | | | 6 | \$ 105.09 |



STIFF/MOYEN

| | | | | | | |
|----------------|---|----|----|-----|----|----------|
| PB-701-GB18-HO | 18"/45 cm Ryno – PVC Stiff fibre fill, Head Only - Green/Black Ryno, fibres en PVC rigide, 18/45 cm po, Tête seulement, vert/noir | 19 | 9 | 4.7 | 12 | \$ 26.39 |
| PB-701-GB24-HO | 24"/60 cm Ryno – PVC Stiff fibre fill, Head Only - Green/Black Bulldog, fibres en PVC rigide, 24/60 cm po, Tête seulement, vert/noir | 23 | 11 | 1.3 | 12 | \$ 36.72 |
| PB-701-BB18-HO | 18"/45 cm Ryno – PVC Stiff fibre fill, Head Only - Blue/Black Ryno, fibres en PVC rigide, 18/45 cm po, Tête seulement, bleu/noir | 19 | 9 | 4.7 | 12 | \$ 26.39 |
| PB-701-BB24-HO | 24"/60 cm Ryno – PVC Stiff fibre fill, Head Only - Blue/Black Ryno, fibres en PVC rigide, 24/60 cm po, Tête seulement, bleu/noir | 23 | 11 | 1.3 | 12 | \$ 36.72 |
| PB-701-RB18-HO | 18"/45 cm Ryno – PVC Stiff fibre fill, Head Only - Red/Black Bulldog, fibres en PVC rigide, 18/45 cm po, Tête seulement, rouge/noir | 19 | 9 | 4.7 | 12 | \$ 26.39 |
| PB-701-RT24-HO | 24"/60 cm Ryno – PVC Stiff fibre fill, Head Only - Red/Black Ryno, fibres en PVC rigide, 24/60 cm po, Tête seulement, rouge/noir | 23 | 11 | 1.3 | 12 | \$ 36.72 |



**EXTRA STIFF
SUPPLÉMENTAIRE
RIGIDE**

EXTRA STIFF / SUPPLÉMENTAIRE RIGIDE

| | | | | | | |
|----------------|--|----|----|-----|----|----------|
| PB-701-OR18-HO | 18"/45 cm Ryno – PVC Ext Stiff fill, Head Only - Orange/Black Ryno, fibres en PVC supplémentaire rigide, 18/45 cm po, Tête seulement, orange/noir | 19 | 9 | 4.7 | 12 | \$ 26.39 |
| PB-701-OR24-HO | 24"/60 cm Ryno – PVC Ext Stiff fibre fill, Head Only - Orange/Black Ryno, fibres en PVC supplémentaire rigide, 24/60 cm po, Tête seulement, orange/noir | 23 | 11 | 1.3 | 12 | \$ 36.72 |

SQUEEGEE BROOM WITH HANDLE / BALAI RACLOIR AVEC MANCHE



| M2 Code Code M2 | Description | Pack Wt LB (S) Poids (lb) (S) | Pack Wt KG Poids (kg) | Cubic Ft Pi3 | Pack Contenu | List Price Liste des prix |
|--------------------|--|----------------------------------|--------------------------|-----------------|-----------------|------------------------------|
| PB-SQB9824 | 24" Squeegee Broom with Metal Handle / Balai à raclette de 24 po avec poignée en métal | | | | 6 | \$ 38.35 |
| FH-M360-BK | 1" /2.5 cm x 60" / 152 cm Black Metal handle with Hex and hanger cap – Threaded Tip Manche bleu avec capuchon de suspension, droit et à bout non fileté en métal - 1 po/ 2.5 cm x 60 po/ 152 cm | 9 | 4.5 | .6 | 12/6 | \$ 6.70 |

RYNO & BULLDOG HANDLES & BRACES / MANCHE ET ENTRETOISE RYNO ET BULLDOG

Newly designed bolt-on brace /
Nouvelle entretoise à boulonner

Straight Cut Chuck
Coupe droite

Ryno Bracket /
Renfort Ryno



| M2 Code Code M2 | Description | Pack Wt LB (S) Poids (lb) (S) | Pack Wt KG Poids (kg) | Cubic Ft Pi3 | Pack Contenu | List Price Liste des prix |
|--------------------|--|----------------------------------|--------------------------|-----------------|-----------------|------------------------------|
| FH-W360-118NT-CH | Straight Cut Chucked 1-3/4 to 1"D 1-1/8" X 60" / Coupe droite, 1-3/4 à 1 po P 1-1/8 po X 60 po | | | 1 | 25/1 | \$ 10.34 |
| PB-351 | Broom brace - Black / Entretoise pour balai, noir | 4 | 2 | .2 | 12/1 | \$ 6.11 |
| PB-700-BKT | Ryno Bracket Only / Support pour Ryno | .2 | .1 | .1 | 1 | \$ 12.35 |
| PB-700-BKT-60 | Bulldog Connector and 60" - 1 1/8" Tapered Wood Handle / | | | | 1 | \$ 29.95 |

SNOW/SAND BOOT BRUSH / BROSSE À BOTTES - NEIGE/SABLE



- Stainless Steel Bracket
- Support en acier inoxydable

| M2 Code Code M2 | Description | Pack Wt LB (S) Poids (lb) (S) | Pack Wt KG Poids (kg) | Cubic Ft Pi3 | Pack Contenu | List Price Liste des prix |
|--------------------|--|----------------------------------|--------------------------|-----------------|-----------------|------------------------------|
| BB-410 | Bi-Level Boot Brush / Brosse à bottes deux niveaux | 2.95 | 1.34 | .277 | 1 | \$ 116.66 |



FINE SWEEP / POUR POUSSIÈRES FINES

For smooth indoor surfaces / Pour des surfaces intérieures lisses



HORSEHAIR

- Blend of synthetic fibers that effectively captures fine dust particles on smooth indoor surfaces

HORSEHAIR

- Mélange de crin de cheval et de fibres synthétiques qui piège les particules de poussières fines sur les surfaces intérieures lisses

| M2 Code Code M2 | Description | Pack Wt LB (S) Poids (lb) (S) | Pack Wt KG Poids (kg) | Cubic Ft Pi3 | Pack Contenu | List Price Liste des prix |
|--------------------|--|----------------------------------|--------------------------|-----------------|-----------------|------------------------------|
| PB-M14 | 14" / 35 cm Imitation Horsehair & Synthetic Mix - Wood / Balai-poussoir en crin de cheval et fibres synthétiques, 14 po / 35 cm, en bois | 14 | 7 | 1 | 12 | \$ 17.59 |
| PB-M18 | 18" / 45 cm Imitation Horsehair & Synthetic Mix - Wood / Balai-poussoir en crin de cheval et fibres synthétiques, 18 po / 45 cm, en bois | 20 | 9 | 1.3 | 12 | \$ 22.99 |
| PB-M24 | 24" / 60 cm Imitation Horsehair & Synthetic Mix - Wood / Balai-poussoir en crin de cheval et fibres synthétiques, 24 po / 60 cm, en bois | 25 | 11 | 1.7 | 12 | \$ 30.88 |
| PB-M36 | 36" / 90 cm Imitation Horsehair & Synthetic Mix - Wood / Balai-poussoir en crin de cheval et fibres synthétiques, 36 po / 90 cm, en bois | 42 | 19 | 2.7 | 6/1 | \$ 54.37 |



POLYSTYRENE

- Flagged bristles are ideal for us in areas that are affected by detergents and most acid
- Ideal for fine sweeping fine particles of dirt on smooth surfaces indoors

POINTES MARQUÉES BLEU

- Les poils à pointes marquées sont idéals aux endroits endommagés par les détergents et la plupart des produits acides.
- Idéales pour balayer des fines particules de salissures sur des surfaces intérieures lisses

| M2 Code Code M2 | Description | Pack Wt LB (S) Poids (lb) (S) | Pack Wt KG Poids (kg) | Cubic Ft Pi3 | Pack Contenu | List Price Liste des prix |
|--------------------|---|----------------------------------|--------------------------|-----------------|-----------------|------------------------------|
| PB-BT14 | 14" / 35 cm Blue Flagged Tip Fiber - Wood / Pointes marquées, 14" / 35 cm, bleus, en bois | 15 | 7 | 1 | 12 | \$ 15.15 |
| PB-BT18 | 18" / 45 cm Blue Flagged Tip Fiber - Wood / Pointes marquées, 18" / 45 cm, bleus, en bois | 20 | 9 | 1.3 | 12 | \$ 20.35 |
| PB-BT24 | 24" / 60 cm Blue Flagged Tip Fiber - Wood / Pointes marquées, 24" / 60 cm, bleus, en bois | 25 | 11 | 1.7 | 12 | \$ 25.89 |
| PB-BT36 | 36" / 90 cm Blue Flagged Tip Fiber - Wood / Pointes marquées, 36" / 90 cm, bleus, en bois | 42 | 19 | 2.7 | 6/1 | \$ 47.63 |



TAMPICO

- Soft to medium texture with good durability
- An Overall "all purpose" broom that is ideal in any warehouse or indoor facility where fine particles need to be swept or picked up

FIBRES DE TAMPICO

- Texture de souple à moyenne avec une bonne résistance
- Un balai tout usage idéal pour enlever les particules fines dans un entrepôt ou une installation intérieure

| M2 Code Code M2 | Description | Pack Wt LB (S) Poids (lb) (S) | Pack Wt KG Poids (kg) | Cubic Ft Pi3 | Pack Contenu | List Price Liste des prix |
|--------------------|--|----------------------------------|--------------------------|-----------------|-----------------|------------------------------|
| PB-T14 | 14" / 35 cm Tampico Fiber - All purpose - Wood /Fibres de tampico, 14" / 35 cm, tout usage, en bois | 15 | 7 | 1 | 12 | \$ 12.98 |
| PB-T18 | 18" / 45 cm Tampico Fiber - All purpose - Wood /Fibres de tampico, 18" / 45 cm, tout usage, en bois | 20 | 9 | 1.3 | 12 | \$ 16.79 |
| PB-T24 | 24" / 60 cm Tampico Fiber - All purpose - Wood / Fibres de tampico, 24" / 60 cm, tout usage, en bois | 25 | 11 | 1.7 | 12 | \$ 21.03 |
| PB-T36 | 36" / 90 cm Tampico Fiber - All purpose - Wood / Fibres de tampico, 36" / 90 cm, tout usage, en bois | 42 | 19 | 2.7 | 6/1 | \$ 37.37 |

MEDIUM SWEEP / POUR POUSSIÈRES MOYENNES

For unfinished surfaces / pour des surfaces brutes

POLYPROPYLENE /PET FILL

- Extremely resilient and has probably the best recovery rate of all the synthetic fibers
- Ideal where low abrasion is important
- Good resistant to a variety of chemicals

FIBRE POLYPROPYLENE/PET

- Extrêmement résistant et possède probablement le meilleur taux de récupération de toutes les fibres synthétique.
- Idéal pour nettoyer les endroits où le frottement doit être faible.
- Bonne résistance à divers produits chimiques



| M2 Code Code M2 | Description | Pack Wt LB (S) Poids (lb) (S) | Pack Wt KG Poids (kg) | Cubic Ft Pi3 | Pack Contenu | List Price Liste des prix |
|--------------------|--|----------------------------------|--------------------------|-----------------|-----------------|------------------------------|
| PB-PE14 | 14" / 35 cm Polypropylene/PET Fiber – Wood / Fibre Polypropylene/PET, 14" / 35 cm, en bois | 15 | 7 | 1 | 12 | \$ 10.91 |
| PB-PE18 | 18" / 45 cm Polypropylene/PET Fiber – Wood / Fibre Polypropylene/PET, 18" / 45 cm, en bois | 20 | 9 | 1.3 | 12 | \$ 14.40 |
| PB-PE24 | 24" / 60 cm Polypropylene/PET Fiber – Wood / Fibre Polypropylene/PET, 24" / 60 cm, en bois | 25 | 11 | 1.7 | 12 | \$ 18.21 |
| PB-PE36 | 36" / 90 cm Polypropylene/PET Fiber – Wood / Fibre Polypropylene/PET, 36" / 90 cm, en bois | 42 | 19 | 2.7 | 6 | \$ 34.11 |

COMBINATION SYNTHETIC FILL

- Ideal as an all-purpose choice for indoors on wood, linoleum or concrete floors
- Can be use outdoors on smooth surfaces
- Use with sweeping compound

MÉLANGE DE FIBRES SYNTHÉTIQUES

- Idéal comme balai tout usage sur des surfaces intérieures en bois, en linoléum ou en béton
- Peut être utilisé sur des surfaces extérieures lisses
- Utiliser avec un composé de balayage



| M2 Code Code M2 | Description | Pack Wt LB (S) Poids (lb) (S) | Pack Wt KG Poids (kg) | Cubic Ft Pi3 | Pack Contenu | List Price Liste des prix |
|--------------------|---|----------------------------------|--------------------------|-----------------|-----------------|------------------------------|
| PB-RB14 | 14" / 35 cm Black/Red – Medium Coarse Synthetic Fill – Wood / Fibres synthétiques moyennes-grossières, 14" / 35 cm, noir/rouge, en bois | 15 | 7 | 1 | 12 | \$ 11.24 |
| PB-RB18 | 18" / 45 cm Black/Red – Medium Coarse Synthetic Fill – Wood / Fibres synthétiques moyennes-grossières, 18" / 45 cm, noir/rouge, en bois | 20 | 9 | 1.3 | 12 | \$ 14.77 |
| PB-RB24 | 24" / 60 cm Black/Red – Medium Coarse Synthetic Fill – Wood / Fibres synthétiques moyennes-grossières, 24" / 60 cm, noir/rouge, en bois | 25 | 11 | 1.7 | 12 | \$ 19.08 |
| PB-RB36 | 36" / 90 cm Black/Red – Medium Coarse Synthetic Fill – Wood / Fibres synthétiques moyennes-grossières, 36" / 90 cm, noir/rouge, en bois | 42 | 19 | 2.7 | 6 | \$ 34.81 |

GARAGE CONCRETE

- Heavy duty durable polystyrene makes this broom ideal for sweeping heavy soils on medium to rough surfaces
- Ideal for working both outdoors and indoors

BALAI GARAGE ET BÉTON

- Ce balai robuste et résistant en polystyrène est idéal sur les surfaces dures ou rugueuses avec déchets importants
- Idéal sur des surfaces intérieures et extérieures



| M2 Code Code M2 | Description | Pack Wt LB (S) Poids (lb) (S) | Pack Wt KG Poids (kg) | Cubic Ft Pi3 | Pack Contenu | List Price Liste des prix |
|--------------------|---|----------------------------------|--------------------------|-----------------|-----------------|------------------------------|
| PB-G14 | 14" / 35 cm Garage Concrete – Wood / Balai garage, 14" / 35 cm, en bois | 15 | 7 | 1 | 12 | \$ 11.17 |
| PB-G18 | 18" / 45 cm Garage Concrete – Wood / Balai garage, 18" / 45 cm, en bois | 20 | 9 | 1.3 | 12 | \$ 14.27 |
| PB-G24 | 24" / 60 cm Garage Concrete – Wood / Balai garage, 24" / 60 cm, en bois | 25 | 11 | 1.7 | 12 | \$ 17.93 |
| PB-G36 | 36" / 90 cm Garage Concrete – Wood / Balai garage, 36" / 90 cm, en bois | 42 | 19 | 2.7 | 6 | \$ 33.61 |



COARSE SWEEP / POUR GROS DÉBRIS

For rough and unfinished surfaces / pour des surfaces rugueuses et brutes



H-BLACK MIX & BASSINE FILL CENTRE

• An all natural pushbroom combining a stiff palmyra centre core surrounded by an outer row of medium fibers.

FIBRES MÉLANGÉES H-BLACK ET CENTRE GARNI DE FIBRES BASSINE

• Un balai-brosse en fibres naturelles avec des fibres bassine raides au centre et des fibres moyennes à l'extérieur

| M2 Code Code M2 | Description | Pack Wt LB (S) Poids (lb) (S) | Pack Wt KG Poids (kg) | Cubic Ft Pi3 | Pack Contenu | List Price Liste des prix |
|--------------------|--|----------------------------------|--------------------------|-----------------|-----------------|------------------------------|
| PB-HB18 | 18" / 45 cm Black Mix & Bassine Centre - Wood / Fibres mélangées et centre en fibres bassine, 18" / 45 cm, noir, en bois | 21 | 10 | 1.3 | 12 | \$ 15.33 |
| PB-HB24 | 24" / 60 cm Black Mix & Bassine Centre - Wood / Fibres mélangées et centre en fibres bassine, 24" / 60 cm, noir, en bois | 30 | 13 | 1.7 | 12 | \$ 19.72 |
| PB-HB36 | 36" / 90 cm Black Mix & Bassine Centre - Wood / Fibres mélangées et centre en fibres bassine, 24" / 60 cm, noir, en bois | 48 | 22 | 2.6 | 6/1 | \$ 41.32 |



BASSINE/ PALMYRA FILL

• Complete natural fiber that poses no harm to the environment
• It has good resistance to friction and heat, and will withstand many chemicals and solvents.
• Ideal for rough surfaces indoors and outdoors in both wet and dry areas

FAIT DE FIBRES BASSINES PALMYRA

• Complètement de fibres naturelles qui ne causent pas de dommage à l'environnement.
• Bonne résistance à la friction et la chaleur, et résistera à plusieurs produits chimiques et solvants.

| M2 Code Code M2 | Description | Pack Wt LB (S) Poids (lb) (S) | Pack Wt KG Poids (kg) | Cubic Ft Pi3 | Pack Contenu | List Price Liste des prix |
|--------------------|--|----------------------------------|--------------------------|-----------------|-----------------|------------------------------|
| PB-BF18 | 18" / 45 cm Bassine Fiber - Wood / Fibres naturelles bassine, 18" / 45 cm, en bois | 24 | 11 | 1.3 | 12 | \$ 13.21 |
| PB-BF24 | 24" / 60 cm Bassine Fiber - Wood / Fibres naturelles bassine, 24" / 60 cm en bois | 32 | 15 | 1.7 | 12 | \$ 17.30 |
| PB-BF36 | 36" / 90 cm Bassine Fiber - Wood / Fibres naturelles bassine, 36" / 90 cm, en bois | 48 | 22 | 2.6 | 6/1 | \$ 30.37 |

RYNO STREET/ BARN PUSHBROOM

Extra coarse broom that is great for heavy duty sweeping

Ideal for street sweeping, cleaning gravel on roofs, and in the construction industry, or where coarse debris needs to be swept • Includes broom, brace and tapered handle • Sold assembled

BALAI-BROSSE DE RUE / GRANGE RYNO

Balai-brosse qui convient parfaitement à un balayage intensif.

Idéal pour le balayage des rues, du gravier sur les toitures et des débris grossiers ou encore dans l'industrie de la construction. • Comprend le balai, l'entretoise et le manche à bout fuselé • Assemblé



| M2 Code Code M2 | Description | Pack Wt LB (S) Poids (lb) (S) | Pack Wt KG Poids (kg) | Cubic Ft Pi3 | Pack Contenu | List Price Liste des prix |
|--------------------|--|----------------------------------|--------------------------|-----------------|-----------------|------------------------------|
| PB-700-ST14 | 14" / 35 cm Ryno Street broom with brace and 60" handle / 14" / 35 cm Balai de rue Ryno avec entretoise et 60 po manche, | 18.5 | 8.5 | | 4 | \$ 40.30 |
| PB-700-ST16 | 16" / 40 cm Ryno Street broom with brace and 60" handle / 16" / 40 cm Balai de rue Ryno avec entretoise et 60 po manche, | 18.5 | 8.5 | | 4 | \$ 44.24 |

STREET / BARN

• Extra coarse fiber broom
• Ideal for street sweeping, roofing, and the construction industry, or where coarse debris need to be swept



RUE ET GRANGE

• Balai à fibres extra dures
• Idéal pour balayer les rues, nettoyer le gravier sur les toitures et des débris grossiers ou encore dans l'industrie de la construction



| M2 Code Code M2 | Description | Pack Wt LB (S) Poids (lb) (S) | Pack Wt KG Poids (kg) | Cubic Ft Pi3 | Pack Contenu | List Price Liste des prix |
|--------------------|---|----------------------------------|--------------------------|-----------------|-----------------|------------------------------|
| PB-ST14 | 14" / 35 cm Polypro Street/Barn - Wood - Head Only / Balai-brosse de rue / grange en polypropylène, 14" / 36 cm, en bois-tête seulement | 33 | 15 | 1.8 | 12 | \$ 14.90 |
| PB-ST16 | 16" / 40 cm Polypro Street/Barn - Wood - Head Only / Balai-brosse de rue / grange en polypropylène, 16" / 40 cm, en bois-tête seulement | 36 | 16 | 2.1 | 12 | \$ 17.47 |
| PB-ST14-54T | 14" Poly-Pro - Wood Stable/Street Broom with 54" tapered handle / 14" balai-brosse écurie/rue en polypropylène avec manche conique 54" | | | | 6 | \$ 26.36 |
| PB-ST16-54T | 16" Poly-Pro - Wood Stable/Street Broom with 54" tapered handle / 16" balai-brosse écurie/rue en polypropylène avec manche conique 54" | | | | 6 | \$ 29.38 |

WOODEN HANDLES / MANCHES EN BOIS

**THREADED
À BOUT FILETÉ**



**METAL TIP
EMBOUT MÉTALLIQUE**



**TAPERED
À BOUT FUSELÉ**



**STRAIGHT CUT
DROIT**



BULLDOG CONNECTOR



| M2 Code Code M2 | Description | Pack Wt LB (S) Poids (lb) (S) | Pack Wt KG Poids (kg) | Cubic Ft Pi3 | Pack Contenu | List Price Liste des prix |
|--|---|----------------------------------|--------------------------|-----------------|-----------------|------------------------------|
| THREADED WOOD / EN BOIS, À BOUT FILETÉ | | | | | | |
| FH-W348 | Threaded Wooden 15/16" x 48" Handles / Manche en bois à bout fileté, 15/16 po x 48 po | 17 | 7.6 | .7 | 25/12 | \$ 5.51 |
| FH-W348-78 | Threaded Wooden 7/8" x 48" Handles / Manche en bois à bout fileté, 7/8 po x 48 po | 17 | 7.6 | .7 | 25/12 | \$ 4.40 |
| FH-W354 | Threaded Wooden 15/16" x 54" Handles / Manche en bois à bout fileté, 15/16 po x 54 po | 22 | 10 | .7 | 25/12 | \$ 6.80 |
| FH-W360 | Threaded Wooden 15/16" x 60" Handles / Manche en bois à bout fileté, 15/16 po x 60 po | 29.5 | 13 | .75 | 25/12 | \$ 7.83 |
| THREADED METAL TIP / EMBOUT MÉTALLIQUE FILETÉ | | | | | | |
| FH-W354MT | Metal threaded tip 15/16" x 54" / Embout métallique fileté, 15/16 po x 54 po | 24.5 | 11 | .7 | 25/12 | \$ 9.30 |
| FH-W360MT | Metal threaded tip 15/16" x 60" / Embout métallique fileté, 15/16 po x 60 po | 26.5 | 12 | .75 | 25/12 | \$ 10.46 |
| FH-W360-118MT | Metal threaded tip 1 1/8" x 60" / Embout métallique fileté, 1 1/8 po x 60 po | 37 | 16.7 | .80 | 25/12 | \$ 13.85 |
| FH-W396-MT | Metal threaded tip 15/16" x 96" / Embout métallique fileté, 15/16" po x 96 po | 44 | 20 | .80 | 25/12 | \$ 19.55 |
| TAPERED WOOD / EN BOIS, À BOUT FUSELÉ | | | | | | |
| FH-W354-118T | Tapered 1-1/8" x 54" / À bout fuselé, 1-1/8 po x 54 po | 33 | 15 | 1 | 25/12 | \$ 9.95 |
| FH-W360-118T | Tapered 1-1/8" x 60" / À bout fuselé 1-1/8 po x 60 po | 39 | 18 | 1 | 25/12 | \$ 10.15 |
| FH-W360-1T | Tapered 1" x 60" / À bout fuselé 1 po x 60 po | 37.5 | 17 | 1 | 25/12 | \$ 9.89 |
| STRAIGHT CUT / DROIT | | | | | | |
| FH-W360NT | Straight cut 15/16" x 60" / Droit, 15/16 po x 60 po | 28.5 | 13 | .75 | 25/12 | \$ 9.57 |
| FH-W354NT-1 | Straight cut 1" x 54" / Droit, 1 po x 54 po | 28.5 | 13 | .75 | 25/12 | \$ 10.55 |
| FH-W354-118NT-CH | Straight Cut Chucked 1-3/4 to 1" D 1-1/8" X 54" / Droit, 1-3/4 à 1 po P 1-1/8 po X 54 po | 33 | 15 | 1 | 25/12 | \$ 9.11 |
| FH-W360-118NT-CH | Straight Cut Chucked 1-3/4 to 1" D 1-1/8" X 60" / Droit, 1-3/4 à 1 po P 1-1/8 po X 60 po | 39 | 18 | 1 | 25/12 | \$ 10.33 |
| PB-BD700-60 | 1/8" Dia. Bulldog Connector Handle Only / Connecteur bulldog - manche seulement - 1/8" po | | | | 24 | \$ 20.02 |

ACCESSORIES

THREADED TO TAPERED ADAPTER

ADAPTEUR POUR FILETÉ À CONIQUE

A truly versatile adapter that lets you modify a variety of handles for tools with tapered inserts

Un adaptateur vraiment polyvalent qui vous permet de modifier une variété de manches pour outils avec insertion conique.



WINDOW BRUSHES / ADAPTEUR POUR FILETÉ À CONIQUE



WASHING SLEEVES / MANCHES DE LAVAGE



WINDOW SQUEEGES / RACLETTES À VITRES



FIBERGLASS HEAVY DUTY HANDLE /



MANCHE EN FIBRE DE VERRE ROBUSTE

EXTENSION HANDLES / MANCHES EXTENSIBLES



METAL FRAME SQUEEGES / SUPPORTS DE RACLETTE EN MÉTAL



MOSS FLOOR SQUEEGES /



RACLOIR À PLANCHER "MOSS"

FH-A35

| M2 Code Code M2 | Description | Pack Wt LB (S) Poids (lb) (S) | Pack Wt KG Poids (kg) | Cubic Ft Pi3 | Pack Contenu | List Price Liste des prix |
|--------------------|--|----------------------------------|--------------------------|-----------------|-----------------|------------------------------|
| FH-A35 | Threaded to Tapered Adapter / Adaptateur conique fileté // Floor squeegee & window squeegees / Fuselé pour adaptateur fileté | | | | 12/1 | \$ 3.37 |
| FH-A36 | Threaded To Locking Collar adapters / Floor squeegee & window squeegees / Fuselé pour adaptateur fileté | | | | 12/1 | \$ 2.34 |





| M2 Code Code M2 | Description | Pack Wt LB (S) Poids (lb) (S) | Pack Wt KG Poids (kg) | Cubic Ft Pi3 | Pack Contenu | List Price Liste des prix |
|---|---|----------------------------------|--------------------------|-----------------|-----------------|------------------------------|
| METAL HANDLES / MANCHES EN MÉTAL | | | | | | |
| FH-M336 | 7/8"/.875 cm - 36"/91 cm Yellow Metal handle with Threaded Tip And Hanger Cap - Black/Black / Manche jaune métallique à bout fileté, 7/8 po/.875 cm - 36"/91 cm avec capuchon de suspension - noir/noir | 7.5 | 3.5 | .5 | 24/12 | \$ 5.20 |
| FH-M348 | 7/8"/.875 cm - 48"/121 cm White Metal Handle with Threaded Tip And Hanger Cap / Manche blanc métallique à bout fileté de 7/8 po/.875 cm - 48 po/121 cm avec capuchon de suspension | | | | 24/12 | \$ 3.33 |
| FH-M348-EU-BL | 7/8"/.875 cm x 48"/121 cm Blue handle with EURO threaded tip and hanger cap / Manche noir; à bout fileté de 7/8 po / .875 cm x 48 po/121 cm avec capuchon de suspension | | | | 24/12 | \$ 3.61 |
| FH-M348-BK | 7/8"/.875 cm - 48"/121 cm Black Handle with Threaded Tip And Hanger Cap / Manche noir; à bout fileté de 48"/121 cm avec capuchon de suspension | | | | 24/12 | \$ 3.33 |
| FH-M348-RD | 7/8"/.875 cm - 48"/121 cm Red Handle with Threaded Tip And Hanger Cap / Manche rouge; à bout fileté de 48"/121 cm avec capuchon de suspension | | | | 24/12 | \$ 3.33 |
| FH-M336-2 | 2 Piece 36" Handle / | | | | 24/1 | \$ 6.74 |
| FH-M348-3 | 3 Piece 48" Handle / | | | | 24/1 | \$ 7.44 |
| HEX METAL HANDLES / POIGNÉE MÉTAL HEXAGONALE | | | | | | |
| FH-M348HD-BK | 1"/2.5 cm x 48"/121 cm Black Handle with Hex - Threaded tip and hanger cap - Heavy Duty / Manche noir à bout fileté de 1 po / 2.5 cm x 48 po / 121 avec capuchon de suspension-robuste | | | | 12/6 | \$ 5.68 |
| FH-M348HD-BL | 1"/2.5 cm x 48"/121 cm Blue Handle with Hex - Threaded tip and hanger cap - Heavy Duty / Manche bleu à bout fileté de 1 po / 2.5 cm x 48 po / 121 cm avec capuchon de suspension-robuste | | | | 12/6 | \$ 5.68 |
| FH-M354HD-BK | 1"/2.5 cm x 54"/137 cm Black Handle with Hex - Threaded tip and hanger cap Heavy Duty / Manche noir à bout fileté de 1 po / 2.5 cm x 54 po / 137 cm avec capuchon de suspension-robuste | | | | 12/6 | \$ 6.13 |
| FH-M360 | 1"/2.5 cm - 60"/152 cm Blue Metal Handle with Hex with Threaded Tip And Hanger Cap / Roboste manche bleu à bout fileté de 1 po/ 2.5 cm - 60"/152 cm avec capuchon de suspension-robuste | 9 | 4 | .6 | 12/6 | \$ 6.70 |
| FH-M360-BK | 1"/2.5 cm x 60"/152 cm Black Metal handle with Hex and hanger cap - Threaded Tip / Manche bleu avec capuchon de suspension, droit et à bout non fileté en metal - 1 po/ 2.5 cm x 60 po/ 152 cm | 9 | 4.5 | .6 | 12/6 | \$ 6.70 |
| INTERNAL THREAD METAL HANDLES / POIGNÉES DE MÉTAL À FILETAGE INTERNE | | | | | | |
| FH-M2354-HDBK | 1"/2.5 cm x 54"/137 cm Black Handle with internal thread tip and hanger cap - Heavy Duty / Manche noir à bout fileté de 1 po / 2.5 cm x 54 po/137 cm avec capuchon de suspension-robuste | | | | 12/6 | \$ 5.96 |
| FH-M2360-HDBK | 1"/2.5 cm x 60"/152 cm Black Handle with internal thread tip and hanger cap - Heavy Duty / Manche noir à bout fileté de 1 po / 2.5 cm x 60 po/ 152 cm avec capuchon de suspension-robuste | | | | 12/6 | \$ 5.96 |
| NO THREAD METAL HANDLES / POIGNÉES EN MÉTAL NON FILETÉES | | | | | | |
| FH-M360-CH | 1"/2.5 cm - 60"/152 cm Blue Metal Handle with Hanger Cap Straight Cut - No Thread / Manche bleu avec capuchon de suspension, droit et à bout non fileté, 1 po / 2.5 cm - 60"/152 cm | 9 | 4 | .6 | 12/6 | \$ 6.19 |
| ALUMINUM HANDLES / MANCHE EN ALUMINIUM | | | | | | |
| FH-A360 | Aluminum non threaded handle 60" / Manche en aluminium non fileté 60" | | | | 12 | \$ 10.83 |
| FH-A361 | Aluminum threaded handle 60" / Poignée filetée en aluminium 60" | | | | 12 | \$ 15.31 |
| FH-A3648-GN | Aluminum threaded handle 48" - Green / Poignée filetée en aluminium 48" - vert | | | | 12 | \$ 20.71 |
| FH-A360-Colours | Aluminum non threaded handle 60" - Coloured Grips/ Manche en aluminium non fileté 60" - Poignées de couleur | | | | 12 | \$ 11.70 |
| FH-A361-Colours | Aluminum threaded handle 60" - Coloured Grips/ Poignée filetée en aluminium 60" - Poignées de couleur | | | | 12 | \$ 16.53 |

TELESCOPIC METAL HANDLES / MANCHES EN ET MÉTALLIQUE TÉLESCOPIQUE

FH-M378



43" / 109 cm / Extends to / Étend à 79" / 200 cm

FH-A3180



Closed 39" / 100cm - Extends to / Étend 70" / 180cm

FH-3160-T



| M2 Code Code M2 | Description | Pack Wt LB (S) Poids (lb) (S) | Pack Wt KG Poids (kg) | Cubic Ft Pi3 | Pack Contenu | List Price Liste des prix |
|--|---|----------------------------------|--------------------------|-----------------|-----------------|------------------------------|
| TELESCOPIC METAL HANDLE / MANCHE TÉLESCOPIQUE EN METAL | | | | | | |
| FH-M378 | Telescopic Threaded Metal Handle - 43 - 79", Ext 109-200 cm / Manche télescopique en metal 43 - 79", Ext 109 - 200 cm | 9 | 4 | .6 | 24/1 | \$ 14.04 |
| FH-M2748 | Telescopic Handle Closed - 70cm / 27.5" Ext - 122 cm / 48" - Green | 9 | 4 | .6 | 24/1 | \$ 12.01 |
| TELESCOPIC ALUMINIUM HANDLE - NON THREADED / MANCHE TÉLESCOPIQUE EN ALUMINIUM | | | | | | |
| FH-A3160 | Telescopic Handle (Closed 97 cm / 38") Extended 157 cm / 61" | | | | 1 | \$ 22.74 |
| FH-A3160-T | Telescopic Threaded Handle - 39"- 70"-100cm-180 cm / Manche télescopique fileté 39"- 70"-100cm-180 cm | | | | 20/1 | \$ 27.41 |
| FH-A3180 | Telescopic Non Threaded Handle - 39"- 70"-100cm-180 cm / Manche télescopique non fileté 39"- 70"-100cm-180 cm | | | | 20/1 | \$ 20.01 |

FIBERGLASS THREADED HANDLES / MANCHES DE FIBRE DE VERRE À BOUT FILETÉ

Constructed from strands of Fiberglass and a thermoset resin matrix that is molded and cured around the plastic honeycomb wall. Our handles are manufactured from a continuous one-piece structure that will not readily splinter, bend, or delaminate.

They are lightweight yet remarkably strong – tensile strength of 80,000 lbs./36,287 Kg per square inch that will never warp or rot. As well, they are impervious to water, therefore electrically non-conductive.

Fabriqués à partir de brins de fibres de verre et d'une matrice de résine thermosettable qui est moulée et durcie autour d'une paroi en nid d'abeille en plastique.

Les manches sont fabriqués à partir d'une pièce continue qui ne fendra pas, ne pliera pas et ne s'écaillera pas facilement. Ils sont légers, mais remarquablement solides. Leur résistance à la traction de 80 000 lb/ 36,287 Kg par pouce carré permet qu'ils ne se tordent ni ne moisissent. De plus, ils sont imperméables à l'eau, donc électriquement non conducteurs.

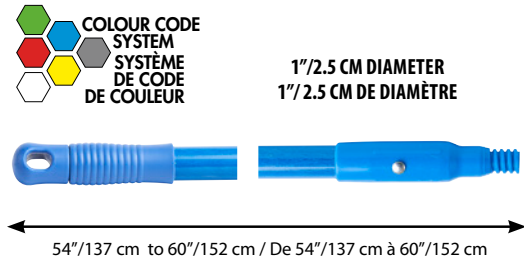

1" / 2.5 CM DIAMETER
1" / 2.5 CM DE DIAMÈTRE



FH-F360-WH-HD



| M2 Code Code M2 | Description | Pack Wt LB (S) Poids (lb) (S) | Pack Wt KG Poids (kg) | Cubic Ft Pi3 | Pack Contenu | List Price Liste des prix |
|--|---|----------------------------------|--------------------------|-----------------|-----------------|------------------------------|
| FH-F330-WH | 30"/76 cm Fiberglass Handle – White / Manche de fibre de verre, 30"/76 cm, blanc | 15 | 6.7 | .5 | 12 | \$ 23.80 |
| FH-F348-Colour | 30"/76 cm Fiberglass Handle – WH, GN, BL, RD, YE / Manche de fibre de verre, 30"/76 cm, – WH, GN, BL, RD, YE | 15 | 6.7 | .5 | 12 | \$ 23.80 |
| FH-F354-BL | 54"/137 cm -Fiberglass Handle – Blue / Manche de fibre de verre, 54"/137 cm bleu | 15 | 6.7 | .5 | 12 | \$ 22.52 |
| FH-F354-WH | 54"/137 cm -Fiberglass Handle – White / Manche de fibre de verre, 54"/137 cm blanc | 15 | 6.7 | .5 | 12 | \$ 22.52 |
| FH-F360-BL | 60"/152 cm Fiberglass Handle –Blue / Manche de fibre de verre, 60"/152 cm, BLue | 16.5 | 7.5 | .5 | 12 | \$ 22.52 |
| FH-F360-GN | 60"/152 cm Fiberglass Handle – Green / Manche de fibre de verre, 60"/152 cm, vert | 16.5 | 7.5 | .5 | 12 | \$ 22.52 |
| FH-F360-WH | 60"/152 cm Fiberglass Handle – White / Manche de fibre de verre, 60"/152 cm, blanc | 16.5 | 7.5 | .5 | 12 | \$ 22.52 |
| FH-F360-YL | 60"/152 cm Fiberglass Handle – Yellow / Manche de fibre de verre, 60"/152 cm, jaune | 16.5 | 7.5 | .5 | 12 | \$ 22.52 |
| FH-F360-RD | 60"/152 cm Fiberglass Handle – Red / Manche de fibre de verre, 60"/152 cm, rouge | 16.5 | 7.5 | .5 | 12 | \$ 22.52 |
| FH-F360-OR | 60"/152 cm Fiberglass Handle – Orange / Manche de fibre de verre, 60"/152 cm, orange | 16.5 | 7.5 | .5 | 12 | \$ 22.52 |
| NON THREADED FIBERGLASS HANDLE - PLEASE SPECIFY COLOUR WHEN ORDERING / MANCHE EN FIBRE DE VERRE NON FILETÉ - S.V.P. SPÉCIFIÉ LA COULEUR LORS DE LA COMMANDE | | | | | | |
| FH-F360NT-BL | 1" x 60"/152 cm Fiberglass-Blue handle NoThread / Droit, Manche de fibre de verre, 1 po x 60 po /152 cm- bleu | 16.5 | 7.5 | .5 | 12/1 | \$ 20.30 |
| FH-F360-RD | 1" x 60"/152 cm Fiberglass-Red handle NoThread / Droit, Manche de fibre de verre, 1 po x 60 po /152 cm - rouge | 16.5 | 7.5 | .5 | 12 | \$ 21.32 |
| FH-F360-GN | 1" x 60"/152 cm Fiberglass-Green handle NoThread / Droit, Manche de fibre de verre, 1 po x 60 po /152 cm - vert | 16.5 | 7.5 | .5 | 12 | \$ 21.32 |
| FH-F360-YL | 1" x 60"/152 cm Fiberglass-Yellow handle NoThread / Droit, Manche de fibre de verre, 1 po x 60 po /152 cm - jaune | 16.5 | 7.5 | .5 | 12 | \$ 21.32 |
| FH-F360-WH | 1" x 60"/152 cm Fiberglass-White handle NoThread / Droit, Manche de fibre de verre, 1 po x 60 po /152 cm - blanc | 16.5 | 7.5 | .5 | 12 | \$ 21.32 |
| FH-F354NT1516-BL | 54"/137 cm Fiberglass-Blue handle NoThread - 15/16" Dia. /Droit, Manche de fibre de verre, 54"/137 cm - 15/16 po-Dia. | 16.5 | 7.5 | .5 | 12/1 | \$ 20.30 |
| FH-F360NT1516-BL | 60"/152 cm Fiberglass-Blue handle NoThread - 15/16" Dia. /Droit, Manche de fibre de verre, 60"/152 cm - 15/16 po-Dia. | | | | 12/1 | \$ 19.99 |

ACCESSORIES / ACCESSOIRES TOOL BRACKET HOLDER / SUPPORT À OUTILS



- Tool Bracket helps you organize your maintenance tools
- 4 Adjustable brackets easily slide to accommodate a variety of tool widths
- Support à outils à attaches pour bien ranger les outils
- Quatre attaches réglables qui glissent facilement pour pouvoir mettre des outils de différentes largeurs.

Additional Clips can be added if required
Possibilité d'ajouter des attaches, le cas échéant



Measures 18" / 45 cm L – 2 7/8" / 7 cm – H X 2" / 5cm D
Mesure 18" / 45 cm L – 2 7/8" / 7 cm – H X 2" / 5cm D



| M2 Code Code M2 | Description | Pack Wt LB (S) Poids (lb) (S) | Pack Wt KG Poids (kg) | Cubic Ft Pi3 | Pack Contenu | List Price Liste des prix |
|--------------------|---|----------------------------------|--------------------------|-----------------|-----------------|------------------------------|
| TL-101 | Single Clip Holder Only / Attache de support à outils | 3.6 | 1.6 | .3 | 12/1 | \$ 12.47 |
| TL-104 | 4 Clip Tool Holder / Support à outils 4 attaches | 10 | 5 | 1.2 | 12/1 | \$ 38.72 |
| FP-TL9110 | 10" Aluminum Tool Holder/Hanger / Blue, Red, Green, Yellow, White / | 10 | 5 | 1.2 | 6/1 | \$ 22.04 |



MOSS PLASTIC FLOOR SQUEEGEE PROFESSIONAL / RACLOIR À PLANCHER PROFESSIONNEL EN CAOUTCHOUC MOUSSE - CANNELURE PLASTIQUE

- With Natural Dura-flex Rubber
- Dura-Flex rubber is recommended when hygiene is extremely important. Ideal for applications within a HACCP system
- Available in 5 colors (blue, green, white, yellow and red)
- Ideal for applications within a HACCP system

- Caoutchouc naturel Dura-flex
- Le caoutchouc Dura-flex est recommandé où l'hygiène est très importante
- Disponible e 5 couleurs (bleu, vert, blanc, jaune et rouge)
- déale pour le système HACCP



Approuvé par la
FDA
Approved

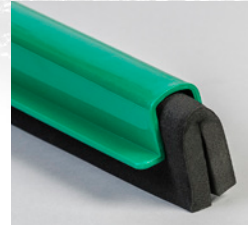

**100% CLOSED CELL RUBBER THAT WILL NOT
HARBOR BACTERIA /
FABRIQUÉ À 100% DE CAOUTCHOUC À CELLULES
FERMÉES QUI N'ABRITERA PAS LES BACTÉRIES**



| M2 Code Code M2 | Description | Pack Wt LB (S) Poids (lb) (S) | Pack Wt KG Poids (kg) | Cubic Ft Pi3 | Pack Contenu | List Price Liste des prix |
|--------------------|--|----------------------------------|--------------------------|-----------------|-----------------|------------------------------|
| FS-MP24-WH | 24"/60 cm Moss Plastic Squeegee with Natural Rubber - White / Raclette en caoutchouc mousse naturel - cannelure plastique, 24 po / 55cm -blanc | | | | 6/1 | \$ 36.85 |
| FS-MP24-GN | 24"/60 cm Moss Plastic Squeegee with Natural Rubber - Green/ Raclette en caoutchouc mousse naturel - cannelure plastique, 24 po / 60cm -vert | | | | 6/1 | \$ 36.85 |
| FS-MP24-BL | 24"/60cm Moss Plastic Squeegee with Natural Rubber - Blue / Raclette en caoutchouc mousse naturel - cannelure plastique, 24 po / 60cm -bleu | | | | 6/1 | \$ 36.85 |
| FS-MP24-RD | 24"/60 cm Moss Plastic Squeegee with Natural Rubber - Red / Raclette en caoutchouc mousse naturel - cannelure plastique, 24 po / 60cm -rouge | | | | 6/1 | \$ 36.85 |
| FS-MP18-YE | 18"/45 cm Moss Plastic Squeegee with Natural Rubber - Yellow / Raclette en caoutchouc mousse naturel - cannelure plastique, 18 po / 45cm -jaune | | | | 6/1 | \$ 36.85 |
| FS-MP24-YE | 24"/60 cm Moss Plastic Squeegee with Natural Rubber - Yellow / Raclette en caoutchouc mousse naturel - cannelure plastique, 24 po / 60cm -jaune | | | | 6/1 | \$ 36.85 |
| FS-MP30-WH | 30"/76 cm Moss Plastic Squeegee with Natural Rubber - White / Raclette en caoutchouc mousse naturel - cannelure plastique, 30 po / 76cm -blanc | | | | 6/1 | \$ 43.52 |

HYGIENIC MONOBLADE SQUEEGEES

Where hygiene is of primary importance to the food industry, professional kitchen, hospital, labs and pharmaceutical industry

RACLETTE HYGIÉNIQUE MONO-LAME

Où l'hygiène est d'une importance primordiale: l'industrie alimentaire, les cuisines professionnelles, les hôpitaux, les laboratoires et l'industrie pharmaceutique.

Smooth Water Flow /
Écoulement doux de l'eau

Approuvé par la
FDA
Approved

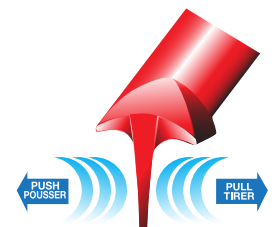

- Optimal socket handle design
- Protected soft touch edges
- Ideal for smooth surfaces
- Autoclavable 138o C / 280o F
- One piece squeegee: no hidden bacteria
- High tear and wear resistance
- Use for floor and walls

- Conception optimale de la poignée
- Bords Tactiles protégés
- Idéal pour les surfaces lisses
- Stérilisation à la vapeur 138C/280F
- Raclette d'une seule pièce: pas de bactérie cachée
- Haute résistance aux déchirures et à l'usure
- Utilisez pour les planchers et les murs



Colour coded handles
also available

Manches de couleur
aussi disponibles

| | | | | | | |
|-------------|--|--|--|--|-----|-----------|
| FS-MB224-WH | 24"/60 cm MonoBlade Floor Squeegee with Scraper - White / 24"/60 cm Raclette à plancher mono-lame avec racloir - blanc | | | | 6/1 | \$ 113.52 |
| FS-MB224-GN | 24"/60 cm MonoBlade Floor Squeegee with Scraper - Green/ 24"/60 cm Raclette à plancher mono-lame avec racloir - vert | | | | 6/1 | \$ 113.52 |
| FS-MB224-BL | 24"/60 cm MonoBlade Floor Squeegee with Scraper - Blue / 24"/60 cm Raclette à plancher mono-lame avec racloir -bleu | | | | 6/1 | \$ 113.52 |
| FS-MB224-RD | 24"/60 cm MonoBlade Floor Squeegee with Scraper - Red / 24"/60 cm Raclette à plancher mono-lame avec racloir - rouge | | | | 6/1 | \$ 113.52 |
| FS-MB224-YE | 24"/60 cm MonoBlade Floor Squeegee with Scraper - Yellow / 24"/60 cm Raclette à plancher mono-lame avec racloir - jaune | | | | 6/1 | \$ 113.52 |

MOSS PROFESSIONAL PUSH-N-SCRUB PLASTIC FLOOR SQUEEGEE / RACLOIR À PLANCHER PROFESSIONNEL PUSH-N-SCRUB EN CAOUTCHOUC MOUSSE - CANNELURE PLASTIQUE



| M2 Code Code M2 | Description | Pack Wt LB (S) Poids (lb) (S) | Pack Wt KG Poids (kg) | Cubic Ft Pi3 | Pack Contenu | List Price Liste des prix |
|--|---|----------------------------------|--------------------------|-----------------|-----------------|------------------------------|
| PUSH-N-SCRUB PLASTIC FLOOR SQUEEGEE - PROFESSIONAL / RACLOIR À PLANCHER PROFESSIONNEL PUSH-N-SCRUB EN PLASTIQUE | | | | | | |
| FS-MPS18 | MOSS Push-N-Scrub Squeegee Plastic with Natural Rubber – 18"/45cm / Racloir à plancher en caoutchouc mousse naturel - cannelure plastique, 18 po / 45cm | 7 | 3.1 | .95 | 10/1 | \$ 31.84 |
| FS-MPS22 | MOSS Push-N-Scrub Squeegee Plastic with Natural Rubber – 22"/55cm / Racloir Push-N-Scrub en caoutchouc mousse naturel - cannelure plastique, 22 po / 55cm | 8 | 3.6 | 1.1 | 10/1 | \$ 35.93 |

MOSS PROFESSIONAL FLOOR SQUEEGEE / RACLOIR À PLANCHER PROFESSIONNEL "MOSS"

* Handles Sold Separately
FH-F3541516NT-BL on Page 66

* Le manche est vendu séparément
* FH-F3541516NT-BL à la page 66



- M2 MOSS Professional Floor squeegees are corrosion – resistant polypropylene floor squeegee are ideal for removing water and dirt from any type of floor.
- Made of a double closed-cell foam rubber with a universal handle socket
- Soft rubber for colder environments

- Le raclette professionnelle M2 "MOSS" est résistant à la corrosion, le racloir à plancher en polypropylène est idéal pour éliminer l'eau et la saleté solide humide de tous les types de planchers.
- Fait d'une double mousse à cellules fermées avec une douille de manche universel.
- Caoutchouc souple pour les environnements plus froids

| M2 Code Code M2 | Description | Pack Wt LB (S) Poids (lb) (S) | Pack Wt KG Poids (kg) | Cubic Ft Pi3 | Pack Contenu | List Price Liste des prix |
|--------------------|--|----------------------------------|--------------------------|-----------------|-----------------|------------------------------|
| FS-P4518 | MOSS Professional Floor squeegee 18"/45cm / Raclette professionnelle "MOSS" 45cm/18" | 21 | 9.9 | | 10/1 | \$ 19.48 |
| FS-P5522 | MOSS Professional Floor squeegee 22"/55cm / Raclette professionnelle "MOSS" 55cm/22" | 22 | 10 | | 10/1 | \$ 22.46 |
| FS-P7530 | MOSS Professional Floor squeegee 30"/75cm / Raclette professionnelle "MOSS" 75cm/30" | 29 | 13 | | 10/1 | \$ 29.76 |
| FH-A36 | Threaded To Locking Collar adapters / Floor squeegee & window squeegees / Adaptateur de vissé a barré-racloir a plancher ou vitre | | | | 12/1 | \$ 2.34 |



MOSS FLOOR SQUEEGEE / RACLOIR À PLANCHER "MOSS"



- Heavy duty floor squeegee with splash guard and reinforced handle socket
- Universal socket with built-in screw & nut - fits all straight and tapered handles with diameter less than 23 mm
- Perfect for professional use and to clean a large surface
- Metal frame: rust resistant galvanized steel
- Available in black and red natural Dura-Flex rubber

- Racloir à plancher robuste avec anti-éclaboussure et prise de manche renforcé
- La prise universelle avec vis et écrous intégrés convient à tous les manches droits et coniques avec un diamètre inférieur à 23mm.
- Parfait pour usage professionnel et le nettoyage de larges surfaces
- Cadre de métal : acier galvanisé résistant à la rouille
- Disponible en caoutchouc « Dura-Flex » noir et rouge



FH-W360-1T FH-F354NT1516-BL



FH-A35



FH-A36



FH-A37



Oil resistant
Résistant à l'huile



| M2 Code Code M2 | Description | Pack Wt LB (S) Poids (lb) (S) | Pack Wt KG Poids (kg) | Cubic Ft Pi3 | Pack Contenu | List Price Liste des prix |
|---|--|----------------------------------|--------------------------|-----------------|-----------------|------------------------------|
| MOSS FLOOR SQUEEGEE WITH UNIVERSAL HANDLE SOCKET (Screw & Nut) / RACLOIR À PLANCHER EN CAOUTCHOUC MOUSSE AVEC DOUILLE UNIVERSELLE (vis et écrou) | | | | | | |
| FS-M622 | MOSS Floor Squeegee with Natural Rubber – 22"/55 cm / FS-M18 Racloir à plancher en caoutchouc mousse naturel - 22 po / 55 cm | 14.9 | 6.8 | .35 | 10/1 | \$ 12.17 |
| FS-M18 | MOSS Floor Squeegee with Natural Rubber – 18"/45 cm / FS-M18 Racloir à plancher en caoutchouc mousse naturel - 18 po / 45 cm | 14.9 | 6.8 | .35 | 10/1 | \$ 12.17 |
| FS-M22 | MOSS Floor Squeegee with Natural Rubber – 22"/55 cm / Racloir à plancher en caoutchouc mousse naturel - 22 po / 55 cm | 33.9 | 15.4 | .44 | 10/1 | \$ 17.18 |
| MOSS HEAVY DUTY SQUEEGEE / SQUEEGEE MOSS ROBUSTE | | | | | | |
| FS-MH18 | MOSS Squeegee with Natural Rubber 18"/45 cm Heavy Duty / Raclette à plancher Robuste en caoutchouc mousse naturel - 18 po / 45cm | 15 | 7.2 | | 10/1 | \$ 24.05 |
| FS-MH22 | MOSS Squeegee with Natural Rubber 22"/55 cm Heavy Duty / Raclette à plancher Robuste en caoutchouc mousse naturel - 22 po / 55cm | 34 | 15.4 | | 10/1 | \$ 27.15 |
| FS-MH30 | MOSS Heavy Duty Floor Squeegee with Natural Rubber – 30"/75 cm / Racloir à plancher robuste en caoutchouc mousse naturel - 30 po / 75 cm | 34 | 7.26 | | 10/1 | \$ 35.46 |
| FS-MH22-RD | MOSS Squeegee Heavy Duty with Neoprene Red Oil Resistant Rubber – 22"/55 cm Racloir à plancher robuste en caoutchouc mousse naturel - 22 po / 55 cm – rouge - Résistant à l'huile | 34 | 15.4 | | 10/1 | \$ 31.31 |
| FS-MH30-RD | MOSS Squeegee Heavy Duty with Neoprene Red Oil Resistant Rubber – 30"/75 cm Racloir à plancher robuste en caoutchouc mousse naturel - 30 po / 76 cm – rouge - Résistant à l'huile | 34 | 15.4 | | 10/1 | \$ 47.42 |
| MOSS SQUEEGEE HANDLES / MANCHE DE BOIS À BOUT FUSELÉ | | | | | | |
| FH-W360-1T | Tapered 1" x 60" / À bout fuselé 1 po x 60 po | | | 1 | 25/1 | \$ 7.91 |
| FH-F354NT1516-BL | Fiberglass Handle - No thread - 54" x 15/16" - Blue / Droit, Manche de fibre de verre, 54" x 15/16 po – bleu | | | 1 | 12/1 | \$ 19.99 |
| FH-A36 | Threaded To Locking Collar adapters / Floor squeegee & window squeegees / Adaptateur de vissé à barré-racloir a plancher ou vitre | | | | 12/1 | \$ 2.34 |
| FH-A35 | Threaded to Tapered Adapter / Adaptateur conique fileté | | | | 12/1 | \$ 3.37 |
| FH-A37 | Threaded Insert Only for Mus Metal Floor Squeegees / Embout fileté seulement pour Mus raclette à plancher métallique | | | | 10/1 | \$ 4.13 |

METAL FRAME SQUEEGEES / CADRE MÉTALLIQUE DE RACLOIR DROIT



Straight Handle
Floor Squeegee uses
1 1/8" Tapered Handle



24" Straight Floor Squeegee With
54" Tapered Handle Complete

Poignée droite
Usages pour racloir
à plancher
Poignée conique
1 1/8"

* Handles Sold Separately
* Refer to page ----- Tapered Handle

* Le manche est vendu séparément
* Se reporter à la page ----- Poignées coniques

| M2 Code Code M2 | Description | Pack Wt LB (S) Poids (lb) (S) | Pack Wt KG Poids (kg) | Cubic Ft Pi3 | Pack Contenu | List Price Liste des prix |
|--|--|----------------------------------|--------------------------|-----------------|-----------------|------------------------------|
| STRAIGHT METAL FRAME SQUEEGEE / CADRE MÉTALLIQUE DE RACLOIR DROIT | | | | | | |
| FS-S518 | 18"/45 cm Straight Floor Squeegee / Raclor à plancher droit, 18 po / 45 cm | 25 | 11 | 1.7 | 12 | \$ 29.05 |
| FS-S524 | 24"/60 cm Straight Floor Squeegee / Raclor à plancher droit, 24 po / 60 cm | 29 | 13 | 2.4 | 12 | \$ 32.01 |
| FS-S530 | 30"/75 cm Straight Floor Squeegee / Raclor à plancher droit, 30po / 75 cm | 25 | 11 | 1.7 | 6 | \$ 54.01 |
| FS-S536 | 36"/60 cm Straight Floor Squeegee / Raclor à plancher droit, 36 po / 91 cm | 29 | 13 | 2.4 | 6 | \$ 64.98 |
| HEAVY DUTY CURVED SQUEEGEE / RACLOIR COURBÉ USAGE INTENSIF | | | | | | |
| FS-C524 | 24"/60 cm Curved Floor Squeegee - Grey / Raclor à plancher courbé, 24 po / 60cm - gris | 26 | 12 | 2.4 | 12 | \$ 62.10 |
| FS-C536 | 36"/91 cm Curved Floor Squeegee- Grey / Raclor à plancher courbé, 36 po / 91 cm - gris | 26 | 12 | 2.4 | 6 | \$ 78.78 |
| FLOOR SQUEEGEE STRAIGHT COMBO / | | | | | | |
| FS-S524-54 | 24"/60 cm Straight Floor Squeegee with 54" Tapered Handle - Grey | .07 | .03 | | 12 | \$ 44.44 |
| TAPERED WOOD HANDLES FOR STRAIGHT & CURVED SQUEEGEES / MANCHES À BOUT FUSÉLÉ POUR LES RACLETTES DROITES OU COURBÉES | | | | | | |
| FH-W354-118T | Tapered 1-1/8" x 54" / À bout fuselé 1-1/8 po x 54 po | | | 1 | 25 | \$ 7.96 |
| FH-W360-118T | Tapered 1 1/8" x 60" / À bout fuselé 1 1/8 po x 60 po | | | 1 | 25 | \$ 8.36 |
| FH-W360-1T | Tapered 1" x 54" / À bout fuselé 1 po x 54 po | | | 1 | 25 | \$ 7.91 |
| SQUEEGEE REFILL / LAME DE RECHANGE | | | | | | |
| FS-S18R | 18"/45 cm Rubber Squeegee Refill / Lame de rechange de racloir en caoutchouc mousse, 18 po / 45 cm | .07 | .03 | | 48/1 | \$ |
| | 24"/60 cm Rubber Squeegee Refill / Lame de rechange de en caoutchouc mousse, 24 po / 60 cm | .07 | .03 | | 24/1 | \$ |



SUPER LOOPER - NARROW BAND / LA VADROUILLE SUPER LOOPER À BANDE ÉTROITE

HEADBAND COLOURS ON MOPS /
COULEUR DE LA BANDE DE
TÊTE SUR LES VADROUILLES



SMALL / PETIT



MEDIUM / MOYEN



LARGE / MOYEN



X-LARGE / EXTRA-GRAND

| M2 Code Code M2 | Description | Pack Wt LB (S) Poids (lb) (S) | Pack Wt KG Poids (kg) | Cubic Ft Pi3 | Pack Contenu | List Price Liste des prix |
|--|--|----------------------------------|--------------------------|-----------------|-----------------|------------------------------|
| SUPER LOOPER – NARROW BAND – BLUE / SUPER LOOPER, BANDE ÉTROITE, bleu | | | | | | |
| MW-SLR09XS-NB-BL | Super Looper - Extra Small - Narrow Band - Blue / Super Looper, super petit, bande étroite bleu | 9.72 | 4.4 | 1 | 12 | \$ 11.78 |
| MW-SLR1S-NB-BL | Super Looper - Small - Narrow Band - Blue / Super Looper, petite, bande étroite, bleu | 10.8 | 5 | 1 | 12 | \$ 12.73 |
| MW-SLR2M-NB-BL | Super Looper - Medium - Narrow Band - Blue / Super Looper, moyenne, bande étroite, bleu | 13.5 | 6 | 1.5 | 12 | \$ 15.06 |
| MW-SLR3L-NB-BL | Super Looper - Large - Narrow Band - Blue / Super Looper, grande, bande étroite, bleu | 16 | 7 | 1.5 | 12 | \$ 19.06 |
| MW-SLR4XL-NB-BL | Super Looper - X-Large - Narrow Band - Blue / Super Looper, très grande, bande étroite, bleu | 19 | 8.5 | 2 | 12 | \$ 22.83 |
| SUPER LOOPER – NARROW BAND – ORANGE / SUPER LOOPER, BANDE ÉTROITE, ORANGE | | | | | | |
| MW-SLR1S-NB-OR | Super Looper - Small - Narrow Band - Orange / Super Looper, petite, bande étroite, orange | 10.8 | 5 | 1 | 12 | \$ 12.73 |
| MW-SLR2M-NB-OR | Super Looper - Medium - Narrow Band - Orange / Super Looper, moyenne, bande étroite, orange | 13.5 | 6 | 1.5 | 12 | \$ 15.06 |
| MW-SLR3L-NB-OR | Super Looper - Large - Narrow Band - Orange / Super Looper, grande, bande étroite, orange | 16 | 7 | 1.5 | 12 | \$ 19.06 |
| MW-SLR4XL-NB-OR | Super Looper - X-Large - Narrow Band - Orange / Super Looper, très grande, bande étroite, orange | 19 | 8.5 | 2 | 12 | \$ 22.83 |
| SUPER LOOPER – NARROW BAND – GREEN / SUPER LOOPER, BANDE ÉTROITE, vertE | | | | | | |
| MW-SLR1S-NB-GN | Super Looper - Small - Narrow Band - Green / Super Looper, petite, bande étroite, verte | 10.8 | 5 | 1 | 12 | \$ 12.73 |
| MW-SLR2M-NB-GN | Super Looper - Medium - Narrow Band - Green / Super Looper, moyenne, bande étroite, verte | 13.5 | 6 | 1.5 | 12 | \$ 15.06 |
| MW-SLR3L-NB-GN | Super Looper - Large - Narrow Band - Green / Super Looper, grande, bande étroite, verte | 16 | 7 | 1.5 | 12 | \$ 19.06 |
| MW-SLR4XL-NB-GN | Super Looper - X-Large - Narrow Band - Green / Super Looper, très grande, bande étroite, verte | 19 | 8.5 | 2 | 12 | \$ 22.83 |
| SUPER LOOPER – NARROW BAND – WHITE / SUPER LOOPER, BANDE ÉTROITE, blanche | | | | | | |
| MW-SLR1S-NB-WH | Super Looper - Small - Narrow Band - White / Super Looper, petite, bande étroite, blanc | 10.8 | 5 | 1 | 12 | \$ 12.73 |
| MW-SLR2M-NB-WH | Super Looper - Medium - Narrow Band - White / Super Looper, moyenne, bande étroite, blanche | 13.5 | 6 | 1.5 | 12 | \$ 15.06 |
| MW-SLR3L-NB-WH | Super Looper - Large - Narrow Band - White / Super Looper, grande, bande étroite, blanche | 16 | 7 | 1.5 | 12 | \$ 19.06 |
| MW-SLR4XL-NB-WH | Super Looper - X-Large - Narrow Band - White / Super Looper, très grande, bande étroite, blanche | 19 | 8.5 | 2 | 12 | \$ 22.83 |





SUPER LOOPER - WIDE BAND / LA VADROUILLE SUPER LOOPER À BANDE LARGE

HEADBAND COLOURS ON MOPS /
COULEUR DE LA BANDE DE
TÊTE SUR LES VADROUILLES



MINI / MINI



SMALL / PETIT



MEDIUM / MEDIUM



LARGE / MEDIUM



X-LARGE / EXTRA-GRAND

| M2 Code Code M2 | Description | Pack Wt LB (S) Poids (lb) (S) | Pack Wt KG Poids (kg) | Cubic Ft Pi3 | Pack Contenu | List Price Liste des prix |
|--|--|----------------------------------|--------------------------|-----------------|-----------------|------------------------------|
| SUPER LOOPER – WIDE BAND – BLUE / SUPER LOOPER, BANDE LARGE, BLEU | | | | | | |
| MW-SLR09XS-WB-BL | Super Looper - Mini - Wide Band - Blue / Super Looper, Mini, bande large, bleu | 9.72 | 4.4 | 1 | 12 | \$ 12.95 |
| MW-SLR10S-WB-BL | Super Looper - Small - Wide Band - Blue / Super Looper, petite, bande large, bleu | 10.8 | 5 | 1 | 12 | \$ 13.58 |
| MW-SLR11M-WB-BL | Super Looper - Medium - Wide Band - Blue / Super Looper, moyenne, bande large, bleu | 13.5 | 6 | 1.5 | 12 | \$15.79 |
| MW-SLR12L-WB-BL | Super Looper - Large - Wide Band - Blue / Super Looper, grande, bande large, bleu | 16 | 7 | 1.5 | 12 | \$ 19.42 |
| MW-SLR13XL-WB-BL | Super Looper - X-Large - Wide Band - Blue / Super Looper, très grande, bande large, bleu | 19 | 8.5 | 2 | 12 | \$ 23.45 |
| SUPER LOOPER – WIDE BAND – ORANGE / SUPER LOOPER, BANDE LARGE, ORANGE | | | | | | |
| MW-SLR10S-WB-OR | Super Looper - Small - Wide Band - Orange / Super Looper, petite, bande large, orange | 10.8 | 5 | 1 | 12 | \$ 13.58 |
| MW-SLR11M-WB-OR | Super Looper - Medium - Wide Band - Orange / Super Looper, moyenne, bande large, orange | 13.5 | 6 | 1.5 | 12 | \$15.79 |
| MW-SLR12L-WB-OR | Super Looper - Large - Wide Band - Orange / Super Looper, grande, bande large, orange | 16 | 7 | 1.5 | 12 | \$ 19.42 |
| MW-SLR13XL-WB-OR | Super Looper - X-Large - Wide Band - Orange / Super Looper, très grande, bande large, orange | 19 | 8.5 | 2 | 12 | \$ 23.45 |
| SUPER LOOPER – WIDE BAND – GREEN / SUPER LOOPER, BANDE LARGE, VERT | | | | | | |
| MW-SLR10S-WB-GN | Super Looper - Small - Wide Band - Green / Super Looper, petite, bande large, verte | 10.8 | 5 | 1 | 12 | \$ 13.58 |
| MW-SLR11M-WB-GN | Super Looper - Medium - Wide Band - Green / Super Looper, moyenne, bande large, verte | 13.5 | 6 | 1.5 | 12 | \$15.79 |
| MW-SLR12L-WB-GN | Super Looper - Large - Wide Band - Green / Super Looper, grande, bande large, verte | 16 | 7 | 1.5 | 12 | \$ 19.42 |
| MW-SLR13XL-WB-GN | Super Looper - X-Large - Wide Band - Green / Super Looper, très grande, bande large, verte | 19 | 8.5 | 2 | 12 | \$ 23.45 |
| SUPER LOOPER – WIDE BAND – WHITE / SUPER LOOPER, BANDE LARGE, BLANC | | | | | | |
| MW-SLR10S-WB-WH | Super Looper - Small - Wide Band - White / Super Looper, petite, bande large, blanche | 10.8 | 5 | 1 | 12 | \$ 13.58 |
| MW-SLR11M-WB-WH | Super Looper - Medium - Wide Band - White / Super Looper, moyenne, bande large, blanche | 13.5 | 6 | 1.5 | 12 | \$15.79 |
| MW-SLR12L-WB-WH | Super Looper - Large - Wide Band - White / Super Looper, grande, bande large, blanche | 16 | 7 | 1.5 | 12 | \$ 19.42 |
| MW-SLR13XL-WB-WH | Super Looper - X-Large - Wide Band - White / Super Looper, très grande, bande large, blanche | 19 | 8.5 | 2 | 12 | \$ 23.45 |



SWINGER™ / VADROUILLE SWINGER^{MD}

LOOPED END WET MOP / VADROUILLE À FRANGES BOUCLÉES COUPÉS

- Swinger mops are made with 4 ply Rayon blended yarns that can withstand repeated launderings
- Break-in is not necessary
- This highly absorbent mop with mid-range retention is perfect for general any cleaning or any building contractor environments

- Les vadrouilles Swinger sont fabriquées avec un mélange rayonne / fibres synthétiques 4 fils qui peuvent résister à des blanchissages à répétition.
- Ne requiert pas de préparation préalable à l'utilisation.
- Cette vadrouille très absorbante, à rétention moyenne, convient parfaitement au nettoyage général ou dans le milieu de entrepreneur en bâtiment.

| SWINGER - LOOPED / FRANGES BOUCLÉES | | | | | | | | | | |
|-------------------------------------|---|---|---|---|---|---|---|---|---|----|
| | 1 | 2 | 3 | 4 | 5 | 6 | 7 | 8 | 9 | 10 |
| Durability / Durabilité | | | | | | | | | | |
| Absorbency / Absorption | | | | | | | | | | |
| Release / Capacité D'Évacuation | | | | | | | | | | |
| Launderability / Blanchiment | | | | | | | | | | |
| Performance / Performance | | | | | | | | | | |



HEADBAND COLOURS ON NARROW BAND MOPS / COULEURS SUR LA BANDE DE TÊTE SUR LES VADROUILLES À BANDES ÉTROITES



SMALL / PETIT



MEDIUM / MOYEN



LARGE / GRAND

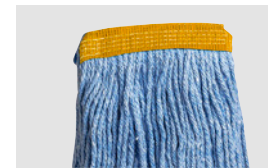

X-LARGE / EXTRA-GRAND

HEADBAND COLOURS ON WIDE BAND MOPS / COULEURS DE LA BANDE DE TÊTE SUR LES VADROUILLES À BANDE LARGE



SMALL / PETIT



MEDIUM / MOYEN



LARGE / GRAND



X-LARGE / EXTRA-GRAND

| M2 Code Code M2 | Description | Pack Wt LB (S) Poids (lb) (S) | Pack Wt KG Poids (kg) | Cubic Ft Pi3 | Pack Contenu | List Price Liste des prix |
|--|--|----------------------------------|--------------------------|-----------------|-----------------|------------------------------|
| SWINGER – LOOPED – NARROW BAND / SWINGER, À FRANGES BOUCLÉES, BANDE ÉTROITE | | | | | | |
| MW-SW1S-NB-BL | Swinger – Small – Narrow Band – Blue / Swinger, petite, bande étroite, bleu | 11 | 5 | 1.3 | 12 | \$ 12.08 |
| MW-SW2M-NB-BL | Swinger – Medium – Narrow Band – Blue / Swinger, moyenne, bande étroite, bleu | 13 | 6 | 1.6 | 12 | \$ 13.55 |
| MW-SW3L-NB-BL | Swinger – Large – Narrow Band – Blue / Swinger, grande, bande étroite, bleu | 16 | 7 | 1.6 | 12 | \$ 15.59 |
| MW-SW4XL-NB-BL | Swinger – Extra Large – Narrow Band – Blue / Swinger, très grande, bande étroite, bleu | 19 | 8.5 | 2.2 | 12 | \$ 18.08 |
| SWINGER – LOOPED – WIDE BAND / SWINGER, À FRANGES BOUCLÉES, BANDE LARGE | | | | | | |
| MW-SW10S-WB-BL | Swinger – Small – Wide Band – Blue / Swinger, petite, bande large, bleu | 11 | 5 | 1.3 | 12 | \$ 12.74 |
| MW-SW11M-WB-BL | Swinger – Medium – Wide Band – Blue / Swinger, moyenne, bande large, bleu | 13 | 6 | 1.6 | 12 | \$ 14.15 |
| MW-SW12L-WB-BL | Swinger – Large – Wide Band – Blue / Swinger, grande, bande large, bleu | 16 | 7 | 1.6 | 12 | \$ 14.85 |
| MW-SW13XL-WB-BL | Swinger – Extra Large – Wide Band – Blue / Swinger, très grande, bande large, bleu | 19 | 8.5 | 2.2 | 12 | \$ 16.26 |

SWINGER™ / VADROUILLE SWINGER^{MD}

LOOPED END WET MOP / VADROUILLE À FRANGES BOUCLÉES



HEADBAND COLOURS ON SWINGER MOPS /
COULEURS DE LA BANDE DE TÊTE SUR LES
VADROUILLES SWINGER



SMALL / PETIT

MEDIUM / MOYEN

LARGE / GRAND

X-LARGE / EXTRA-GRAND

| M2 Code Code M2 | Description | Pack Wt LB (S) Poids (lb) (S) | Pack Wt KG Poids (kg) | Cubic Ft Pi3 | Pack Contenu | List Price Liste des prix |
|--|---|----------------------------------|--------------------------|-----------------|-----------------|------------------------------|
| SWINGER – LOOPED – NARROW BAND / SWINGER, À FRANGES BOUCLÉES, BANDE ÉTROITE | | | | | | |
| MW-SW1S-NB-GN | Swinger – Small – Narrow Band – Green / Swinger, petite, bande étroite, vert | 11 | 5 | 1.3 | 12 | \$ 10.76 |
| MW-SW2M-NB-GN | Swinger – Medium – Narrow Band – Green / Swinger, moyenne, bande étroite, vert | 13 | 6 | 1.6 | 12 | \$ 12.07 |
| MW-SW3L-NB-GN | Swinger – Large – Narrow Band – Green / Swinger, grande, bande étroite, vert | 16 | 7 | 1.6 | 12 | \$ 13.89 |
| MW-SW4XL-NB-GN | Swinger – Extra Large – Narrow Band – Green / Swinger, très grande, bande étroite, vert | 19 | 8.5 | 2.2 | 12 | \$ 16.10 |
| SWINGER – LOOPED – WIDE BAND / SWINGER, À FRANGES BOUCLÉES, BANDE LARGE | | | | | | |
| MW-SW10S-WB-GN | Swinger – Small – Wide Band – Green / Swinger, petite, bande large, vert | 11 | 5 | 1.3 | 12 | \$ 11.34 |
| MW-SW11M-WB-GN | Swinger – Medium – Wide Band – Green / Swinger, moyenne, bande large, vert | 16 | 6 | 1.6 | 12 | \$ 12.60 |
| MW-SW12L-WB-GN | Swinger – Large – Wide Band – Green / Swinger, grande, bande large, vert | 16 | 7 | 1.6 | 12 | \$ 14.48 |
| MW-SW13XL-WB-GN | Swinger – Extra Large – Wide Band – Green / Swinger, très grande, bande large, vert | 19 | 8.5 | 2.2 | 12 | \$ 16.71 |

HEADBAND COLOURS ON SWINGER MOPS /
COULEURS DE LA BANDE DE TÊTE SUR LES
VADROUILLES SWINGER



SMALL / PETIT

MEDIUM / MOYEN

LARGE / GRAND

X-LARGE / EXTRA-GRAND

| M2 Code Code M2 | Description | Pack Wt LB (S) Poids (lb) (S) | Pack Wt KG Poids (kg) | Cubic Ft Pi3 | Pack Contenu | List Price Liste des prix |
|--|--|----------------------------------|--------------------------|-----------------|-----------------|------------------------------|
| SWINGER – LOOPED – NARROW BAND / SWINGER, À FRANGES BOUCLÉES, BANDE ÉTROITE | | | | | | |
| MW-SW1S-NB-OR | Swinger – Small – Narrow Band – Orange / Swinger, petite, bande étroite, orange | 11 | 5 | 1.3 | 12 | \$ 10.76 |
| MW-SW2M-NB-OR | Swinger – Medium – Narrow Band – Orange / Swinger, moyenne, bande étroite, orange | 13 | 6 | 1.6 | 12 | \$ 12.07 |
| MW-SW3L-NB-OR | Swinger – Large – Narrow Band – Orange / Swinger, grande, bande étroite, orange | 16 | 7 | 1.6 | 12 | \$ 13.89 |
| MW-SW4XL-NB-OR | Swinger – Extra Large – Narrow Band – Orange / Swinger, très grande, bande étroite, orange | 19 | 8.5 | 2.2 | 12 | \$ 16.10 |
| SWINGER – LOOPED – WIDE BAND / SWINGER, À FRANGES BOUCLÉES, BANDE LARGE | | | | | | |
| MW-SW10S-WB-OR | Swinger – Small – Wide Band – Orange / Swinger, petite, bande large, orange | 11 | 5 | 1.3 | 12 | \$ 11.34 |
| MW-SW11M-WB-OR | Swinger – Medium – Wide Band – Orange / Swinger, moyenne, bande large, orange | 13 | 6 | 1.6 | 12 | \$ 12.60 |
| MW-SW12L-WB-OR | Swinger – Large – Wide Band – Orange / Swinger, grande, bande large, orange | 16 | 7 | 1.6 | 12 | \$ 14.48 |
| MW-SW13XL-WB-OR | Swinger – Extra Large – Wide Band – Orange / Swinger, très grande, bande large, orange | 19 | 8.5 | 2.2 | 12 | \$ 16.71 |



SWINGER™ TRUE WEIGHT / 'SWINGER™ MD " POIDS RÉEL

LOOPED END WET MOP / VADROUILLE À FRANGES BOUCLÉES COUPÉS

- Swinger mops are made with 4 ply Rayon blended yarns that can withstand repeated launderings
- Break-in is not necessary
- This highly absorbent mop with mid-range retention is perfect for general any cleaning or any building contractor environments

- Les vadrouilles Swinger sont fabriquées avec un mélange rayonne / fibres synthétiques 4 fils qui peuvent résister à des blanchissages à répétition.
- Ne requiert pas de préparation préalable à l'utilisation.
- Cette vadrouille très absorbante, à rétention moyenne, convient parfaitement au nettoyage général ou dans le milieu de neur en bâtiment.

| SWINGER - LOOPED / FRANGES BOUCLÉES | | | | | | | | | | |
|-------------------------------------|---|---|---|---|---|---|---|---|---|----|
| | 1 | 2 | 3 | 4 | 5 | 6 | 7 | 8 | 9 | 10 |
| Durability / Durabilité | | | | | | | | | | |
| Absorbency / Absorption | | | | | | | | | | |
| Release / Capacité d'évacuation | | | | | | | | | | |
| Launderability / Blanchiment | | | | | | | | | | |
| Performance / Performance | | | | | | | | | | |



HEADBAND COLOURS ON NARROW BAND MOPS / COULEURS SUR LA BANDE DE TÊTE SUR LES VADROUILLES À BANDES ÉTROITES



HEADBAND COLOURS ON WIDE BAND MOPS / COULEURS DE LA BANDE DE TÊTE SUR LES VADROUILLES À BANDE LARGE



| M2 Code Code M2 | Description | Pack Wt LB (S) Poids (lb) (S) | Pack Wt KG Poids (kg) | Cubic Ft Pi3 | Pack Contenu | List Price Liste des prix |
|--|---|----------------------------------|--------------------------|-----------------|-----------------|------------------------------|
| SWINGER TRUE WEIGHT – LOOPED – NARROW BAND / SWINGER, À FRANGES BOUCLÉES, BANDE ÉTROITE | | | | | | |
| MW-SW12-NB-BL | Swinger – True Weigh, Looped End– Narrow Band – Blue - 12oz/350g "Swinger" poids réel – embouts bouclés – bande étroite – bleu – 12 on. / 350 gr | 11 | 5 | 1.3 | 12 | \$ 12.91 |
| MW-SW16-NB-BL | Swinger – True Weigh, Looped End– Narrow Band – Blue - 16oz/450g "Swinger" poids réel – embouts bouclés – bande étroite – bleu – 16oz/450g | 13 | 6 | 1.6 | 12 | \$ 14.73 |
| MW-SW20-NB-BL | Swinger – True Weigh, Looped End– Narrow Band – Blue - 20oz/550g "Swinger" poids réel – embouts bouclés – bande étroite – bleu – 20oz/550g | 16 | 7 | 1.6 | 12 | \$ 16.64 |
| MW-SW24-NB-BL | Swinger – True Weigh, Looped End– Narrow Band – Blue - 24oz/650g "Swinger" poids réel – embouts bouclés – bande étroite – bleu – 24oz/650g | 19 | 8.5 | 2.2 | 12 | \$ 19.11 |
| MW-SW32-NB-BL | Swinger – True Weigh, Looped End– Narrow Band – Blue - 32oz/850g "Swinger" poids réel – embouts bouclés – bande étroite – bleu – 32oz/850g | | | | | \$ 23.00 |
| SWINGER – LOOPED – WIDE BAND / SWINGER, À FRANGES BOUCLÉES, BANDE LARGE | | | | | | |
| MW-SW12-WB-BL | Swinger – True Weigh, Looped End– Wide Band – Blue - 12oz/350g "Swinger" poids réel – embouts bouclés – bande large – bleu – 12 on. / 350 gr | 11 | 5 | 1.3 | 12 | \$ 13.91 |
| MW-SW16-WB-BL | Swinger – True Weigh, Looped End– Wide Band – Blue - 16oz/450g "Swinger" poids réel – embouts bouclés – bande large – bleu – 16oz/450g | 13 | 6 | 1.6 | 12 | \$ 15.73 |
| MW-SW20-WB-BL | Swinger – True Weigh, Looped End– Wide Band – Blue - 20oz/550g "Swinger" poids réel – embouts bouclés – bande large – bleu – 20oz/550g | 16 | 7 | 1.6 | 12 | \$ 17.64 |
| MW-SW24-WB-BL | Swinger – True Weigh, Looped End– Wide Band – Blue - 24oz/650g "Swinger" poids réel – embouts bouclés – bande large – bleu – 24oz/650g | 19 | 8.5 | 2.2 | 12 | \$ 20.11 |
| MW-SW32-WB-BL | Swinger – True Weigh, Looped End– Wide Band – Blue - 32oz/850g "Swinger" poids réel – embouts bouclés – bande large – bleu – 2oz/850g | | | | | \$ 24.90 |

SWIPE™ / VADROUILLE SWIPE^{MD}

CUT END / BOUPE

- Swipe mops are made with 4 ply Rayon blended yarns
- Break-in is not necessary
- This highly absorbent mop with medium retention is perfect for any general cleaning or restaurant environments

- Les vadrouilles "Swipe" sont fabriquées de fibres mélangées 4 plis
- Ne requiert pas de préparation préalable à l'utilisation.
- Cette vadrouille très absorbante, à rétention moyenne, convient parfaitement au nettoyage général ou dans le milieu de la restauration.

| SWIPE - CUT END / BRINS COUPÉS | | 1 | 2 | 3 | 4 | 5 | 6 | 7 | 8 | 9 | 10 |
|---------------------------------|--|---|---|---|---|---|---|---|---|---|----|
| Durability / Durabilité | | | | | | | | | | | |
| Absorbency / Absorption | | | | | | | | | | | |
| Release / Capacité D'Évacuation | | | | | | | | | | | |
| Laundability / Blanchiment | | | | | | | | | | | |
| Performance / Performance | | | | | | | | | | | |



HEADBAND COLOURS ON SWIPE MOPS / COULEURS DE LA BANDE DE TÊTE SUR LES VADROUILLES SWIPE



| M2 Code Code M2 | Description | Pack Wt LB (S) Poids (lb) (S) | Pack Wt KG Poids (kg) | Cubic Ft Pi3 | Pack Contenu | List Price Liste des prix |
|---|--|----------------------------------|--------------------------|-----------------|-----------------|------------------------------|
| SWIPE – CUT END – NARROW BAND - BLUE / SWIPE, À FRANGES BOUCLÉES, BANDE ÉTROITE - bleu | | | | | | |
| MW-SWC12-BL | Swipe – Cut End Mop 12 oz – NB – Blue / Swipe, à brins coupés, 12 oz, bande étroite - bleu | 9 | 4 | 1 | 12 | \$ 9.51 |
| MW-SWC16-BL | Swipe – Cut End Mop 16 oz – NB – Blue / Swipe, à brins coupés, 16 oz, bande étroite - bleu | 11 | 5 | 1.3 | 12 | \$ 9.86 |
| MW-SWC20-BL | Swipe – Cut End Mop 20 oz – NB – Blue / Swipe, à brins coupés, 20 oz, bande étroite - bleu | 13 | 6 | 1.6 | 12 | \$ 11.72 |
| MW-SWC24-BL | Swipe – Cut End Mop 24 oz – NB – Blue / Swipe, à brins coupés, 24 oz, bande étroite - bleu | 16.5 | 7 | 1.6 | 12 | \$ 13.64 |
| MW-SWC28-BL | Swipe – Cut End Mop 28 oz – NB – Blue / Swipe, à brins coupés, 28 oz, bande étroite - bleu | 16.5 | 7 | 1.6 | 12 | \$ 15.60 |
| MW-SWC32-BL | Swipe – Cut End Mop 32 oz – NB – Blue / Swipe, à brins coupés, 32 oz, bande étroite - bleu | 19 | 8.5 | 2.2 | 12 | \$ 17.21 |
| SWIPE – CUT END – NARROW BAND - GREEN / SWIPE, À FRANGES BOUCLÉES, BANDE LARGE - vert | | | | | | |
| MW-SWC16-GN | Swipe – Cut End Mop 16 oz – NB – Green / Swipe, à brins coupés, 16 oz, bande étroite - vert | 11 | 5 | 1.3 | 12 | \$ 9.86 |
| MW-SWC20-GN | Swipe – Cut End Mop 20 oz – NB – Green / Swipe, à brins coupés, 20 oz, bande étroite - vert | 13 | 6 | 1.6 | 12 | \$ 11.72 |
| MW-SWC24-GN | Swipe – Cut End Mop 24 oz – NB – Green / Swipe, à brins coupés, 24 oz, bande étroite - vert | 16.5 | 7 | 1.6 | 12 | \$ 13.64 |
| MW-SWC28-GN | Swipe – Cut End Mop 28 oz – NB – Green / Swipe, à brins coupés, 28 oz, bande étroite - vert | 16.5 | 7 | 1.6 | 12 | \$ 15.60 |
| MW-SWC32-GN | Swipe – Cut End Mop 32 oz – NB – Green / Swipe, à brins coupés, 32 oz, bande étroite - vert | 19 | 8.5 | 2.2 | 12 | \$ 17.21 |
| SWIPE – CUT END – NARROW BAND - ORANGE / SWIPE, À BRINS COUPÉS, BANDE ÉTROITE - ORANGE | | | | | | |
| MW-SWC16-OR | Swipe – Cut End Mop 16 oz – NB – Orange / Swipe, à brins coupés, 16 oz, bande étroite - orange | 11 | 5 | 1.3 | 12 | \$ 9.86 |
| MW-SWC20-OR | Swipe – Cut End Mop 20 oz – NB – Orange / Swipe, à brins coupés, 20 oz, bande étroite - orange | 13 | 6 | 1.6 | 12 | \$ 11.72 |
| MW-SWC24-OR | Swipe – Cut End Mop 24 oz – NB – Orange / Swipe, à brins coupés, 24 oz, bande étroite - orange | 16.5 | 7 | 1.6 | 12 | \$ 13.64 |
| MW-SWC28-OR | Swipe – Cut End Mop 28 oz – NB – Orange / Swipe, à brins coupés, 28 oz, bande étroite - orange | 16.5 | 7 | 1.6 | 12 | \$ 15.60 |
| MW-SWC32-OR | Swipe – Cut End Mop 32 oz – NB – Orange / Swipe, à brins coupés, 32 oz, bande étroite - orange | 19 | 8.5 | 2.2 | 12 | \$ 17.21 |



MICROPET MICROFIBER ECO SERIES MOPS MICROPET EN MICROFIBRE SÉRIE DE VADROUILLES ECO



| MICROPET - LOOPED / FRANGES BOUCLÉES | 1 | 2 | 3 | 4 | 5 | 6 | 7 | 8 | 9 | 10 |
|--------------------------------------|---|---|---|---|---|---|---|---|---|----|
| Durability / Durabilité | | | | | | | | | | |
| Absorbency / Absorption | | | | | | | | | | |
| Release / Capacité D'Évacuation | | | | | | | | | | |
| Launderability / Blanchiment | | | | | | | | | | |
| Performance / Performance | | | | | | | | | | |

| MICROPET - CUT END / BRINS COUPÉS | 1 | 2 | 3 | 4 | 5 | 6 | 7 | 8 | 9 | 10 |
|-----------------------------------|---|---|---|---|---|---|---|---|---|----|
| Durability / Durabilité | | | | | | | | | | |
| Absorbency / Absorption | | | | | | | | | | |
| Release / Capacité D'Évacuation | | | | | | | | | | |
| Launderability / Blanchiment | | | | | | | | | | |
| Performance / Performance | | | | | | | | | | |

**MADE FROM 100%
RECYCLED MATERIAL**



**ENTIÈREMENT
FABRIQUÉE AVEC DES
MATÉRIAUX RECYCLÉS**

- This highly absorbent mop with mid-range retention is perfect for any general cleaning application
- High resistance to chemicals and disinfectants
- Break-in is not necessary
- Made with next generation Microfiber and PET plastic soda bottles, this mop can be used in Healthcare environments
- Cette vadrouille très absorbante, à rétention moyenne, convient parfaitement au nettoyage général
- Résistance élevée aux produits chimiques et aux désinfectants
- Ne requiert pas de préparation préalable à l'utilisation
- Fabriquée avec des microfibres de nouvelle génération et des bouteilles de boissons gazeuses post-consommation en plastique (PET), cette vadrouille est très appréciée en milieu hospitalier

MICROPET MICROFIBER ECO SERIES MOPS / VADROUILLES SÉRIES ECO EN MICROFIBRE "MICROPET"



HEADBAND COLOURS ON MICROPET MOPS / COULEURS DE LA BANDE DE TÊTE DE LA VADROUILLE MICROPET



| M2 Code Code M2 | Description | Pack Wt LB (S) Poids (lb) (S) | Pack Wt KG Poids (kg) | Cubic Ft Pi3 | Pack Contenu | List Price Liste des prix |
|---|--|----------------------------------|--------------------------|-----------------|-----------------|------------------------------|
| MICROPET LOOPED END – NARROW BAND / MICROPET À FRANGES BOUCLÉES, BANDE ÉTROITE | | | | | | |
| MW-MPE1S-NB | MicroPET Looped End – Small – Narrow Band / MicroPET, à franges bouclées, petite, bande étroite | 11 | 5 | 1.3 | 12 | \$ 11.58 |
| MW-MPE2M-NB | MicroPET Looped End – Medium – Narrow Band / MicroPET, à franges bouclées, moyenne, bande étroite | 13 | 6 | 1.6 | 12 | \$ 16.44 |
| MW-MPE3L-NB | MicroPET Looped End – Large – Narrow Band / MicroPET, à franges bouclées, grande, bande étroite | 16 | 7 | 1.6 | 12 | \$ 19.96 |
| MW-MPE4XL-NB | MicroPET Looped End – Extra Large – Narrow Band / MicroPET, à franges bouclées, très grande, bande étroite | 19 | 8.5 | 2.2 | 12 | \$ 24.35 |
| MICROPET LOOPED END – WIDE BAND / MICROPET À FRANGES BOUCLÉES, BANDE LARGE | | | | | | |
| MW-MPE10S-WB | MicroPET Looped End – Small – Wide Band / MicroPET, à franges bouclées, petite, bande large | 11 | 5 | 1.3 | 12 | \$ 14.60 |
| MW-MPE11M-WB | MicroPET Looped End – Medium – Wide Band / MicroPET, à franges bouclées, moyenne, bande large | 13 | 6 | 1.6 | 12 | \$ 16.94 |
| MW-MPE12L-WB | MicroPET Looped End – Large – Wide Band / MicroPET, à franges bouclées, grande, bande large | 16 | 7 | 1.6 | 12 | \$ 21.03 |
| MW-MPE13XL-WB | MicroPET Looped End – Extra Large – Wide Band / MicroPET, à franges bouclées, très grande, bande large | 19 | 8.5 | 2.2 | 12 | \$ 24.84 |
| MICROPET CUT END – NARROW BAND / MICROPET À BRINS COUPÉS, BANDE ÉTROITE | | | | | | |
| MW-MPEC12 | 12 oz. MicroPET Cut End – Narrow Band / MicroPET, à brins coupés, bande étroite | 9 | 5.9 | 1.3 | 12 | \$ 7.69 |
| MW-MPEC16 | 16 oz. MicroPET Cut End – Narrow Band / MicroPET, à brins coupés, bande étroite | 13 | 5.9 | 1.3 | 12 | \$ 9.41 |
| MW-MPEC20 | 20 oz. MicroPET Cut End – Narrow Band / MicroPET, à brins coupés, bande étroite | 15 | 6.8 | 1.6 | 12 | \$ 11.17 |
| MW-MPEC24 | 24 oz. MicroPET Cut End – Narrow Band / MicroPET, à brins coupés, bande étroite | 18 | 8.1 | 1.6 | 12 | \$ 12.73 |
| MW-MPEC32 | 32 oz. MicroPET Cut End – Narrow Band / MicroPET, à brins coupés, bande étroite | 24 | 10.8 | 2.2 | 12 | \$ 16.63 |
| MICROPET CUT END – WIDE BAND / MICROPET À BRINS COUPÉS, BANDE LARGE | | | | | | |
| MW-MPEC12-WB | 12 oz. MicroPET Cut End – Wide Band / MicroPET, à brins coupés, bande large | 13 | 6 | 1.3 | 12 | \$ 10.26 |
| MW-MPEC16-WB | 16 oz. MicroPET Cut End – Wide Band / MicroPET, à brins coupés, bande large | 15 | 7 | 1.6 | 12 | \$ 12.24 |
| MW-MPEC20-WB | 20 oz. MicroPET Cut End – Wide Band / MicroPET, à brins coupés, bande large | 18 | 8 | 1.6 | 12 | \$ 14.21 |
| MW-MPEC24-WB | 24 oz. MicroPET Cut End – Wide Band / MicroPET, à brins coupés, bande large | 20 | 9 | 1.7 | 12 | \$ 16.30 |
| MW-MPEC32-WB | 32 oz. MicroPET Cut End – Wide Band / MicroPET, à brins coupés, bande large | 24 | 11 | 2.2 | 12 | \$ 20.43 |



SYNRAY™

CUT END & LOOPED END WET MOPS



* All SynRay Narrow Band Mops
4 Row Stitched

* All SynRay Wide Band Mops
6 Row Stitched

* Toutes les vadrouilles SynRay à bande étroite ont 4 rangées de couture

* Toutes les vadrouilles SynRay à bande large ont 6 rangées de couture

| SYNRAY - LOOPED / FRANGES BOUCLÉES | | | | | | | | | | |
|------------------------------------|---|---|---|---|---|---|---|---|---|----|
| | 1 | 2 | 3 | 4 | 5 | 6 | 7 | 8 | 9 | 10 |
| Durability / Durabilité | | | | | | | | | | |
| Absorbency / Absorption | | | | | | | | | | |
| Release / Capacité D'Évacuation | | | | | | | | | | |
| Launderability / Blanchiment | | | | | | | | | | |
| Performance / Performance | | | | | | | | | | |

VADROUILLES HUMIDES À BRINS COUPÉS ET À FRANGES BOUCLÉES

HEADBAND COLOURS ON SYNRAY MOPS / COULEURS DE LA BANDE DE TÊTE DE LA VADROUILLE SYNRAY



| M2 Code Code M2 | Description | Pack Wt LB (S) Poids (lb) (S) | Pack Wt KG Poids (kg) | Cubic Ft Pi3 | Pack Contenu | List Price Liste des prix |
|---|--|----------------------------------|--------------------------|-----------------|-----------------|------------------------------|
| SYNRAY – CUT END – NARROW BAND – WITHOUT BAG / SYNRAY, À BRINS COUPÉS, BANDE ÉTROITE, SANS SAC | | | | | | |
| MW-SC12 | SYNRAY – Cut End – Narrow Band– 12 oz / 350 g / SYNRAY, à brins coupés, bande étroite, 12 oz / 350 g | 9 | 4 | 1.3 | 12 | \$ 6.99 |
| MW-SC16 | SYNRAY – Cut End – Narrow Band– 16 oz / 450 g / SYNRAY, à brins coupés, bande étroite, 16 oz / 450 g | 13 | 6 | 1.3 | 12 | \$ 8.49 |
| MW-SC20 | SYNRAY – Cut End – Narrow Band– 20 oz / 550 g / SYNRAY, à brins coupés, bande étroite, 20 oz / 550 g | 15 | 7 | 1.6 | 12 | \$ 10.05 |
| MW-SC24 | SYNRAY – Cut End – Narrow Band– 24 oz / 650 g / SYNRAY, à brins coupés, bande étroite, 24 oz / 650 g | 18 | 8 | 1.6 | 12 | \$ 11.41 |
| MW-SC28 | SYNRAY – Cut End – Narrow Band– 28 oz / 750 g / SYNRAY, à brins coupés, bande étroite, 28 oz / 750 g | 20 | 9 | 1.7 | 12 | \$ 13.37 |
| MW-SC32 | SYNRAY – Cut End – Narrow Band– 32 oz / 850 g / SYNRAY, à brins coupés, bande étroite, 32 oz / 850 g | 24 | 11 | 2.2 | 12 | \$ 14.88 |
| SYNRAY – CUT END – WIDE BAND – WITHOUT BAG / SYNRAY, À BRINS COUPÉS, BANDE LARGE, SANS SAC | | | | | | |
| MW-SC16WB | SYNRAY – Cut End – Wide Band – 16 oz / 450 g / SYNRAY, à brins coupés, bande large, 16 oz / 450 g | 13 | 6 | 1.3 | 12 | \$ 9.82 |
| MW-SC20WB | SYNRAY – Cut End – Wide Band – 20 oz / 550 g / SYNRAY, à brins coupés, bande large, 20 oz / 550 g | 15 | 7 | 1.6 | 12 | \$ 11.59 |
| MW-SC24WB | SYNRAY – Cut End – Wide Band – 24 oz / 650 g / SYNRAY, à brins coupés, bande large, 24 oz / 650 g | 18 | 8 | 1.6 | 12 | \$ 13.39 |
| MW-SC32WB | SYNRAY – Cut End – Wide Band – 32 oz / 850 g / SYNRAY, à brins coupés, bande large, 32 oz / 850 g | 24 | 11 | 2.2 | 12 | \$ 17.61 |

SYNRAY™ CUT END WET MOPS / VADROUILLES SYNRAY™ HUMIDES À BRINS COUPÉS



| SYNRAY - CUT END / BRINS COUPÉS | | | | | | | | | | |
|---------------------------------|---|---|---|---|---|---|---|---|---|----|
| | 1 | 2 | 3 | 4 | 5 | 6 | 7 | 8 | 9 | 10 |
| Durability / Durabilité | | | | | | | | | | |
| Absorbency / Absorption | | | | | | | | | | |
| Release / Capacité D'Évacuation | | | | | | | | | | |
| Launderability / Blanchiment | | | | | | | | | | |
| Performance / Performance | | | | | | | | | | |

| M2 Code Code M2 | Description | Pack Wt LB (S) Poids (lb) (S) | Pack Wt KG Poids (kg) | Cubic Ft Pi3 | Pack Contenu | List Price Liste des prix |
|---|---|----------------------------------|--------------------------|-----------------|-----------------|------------------------------|
| SYNRAY – CUT END – NARROW BAND – BAGGED / SYNRAY, À BRINS COUPÉS, BANDE ÉTROITE, ENSACHÉ | | | | | | |
| MW-SC12B | SYNRAY – Cut End – Narrow Band – 12 oz / 350 g / SYNRAY, à brins coupés, bande étroite, 12 oz / 350 g | 9 | 4 | 1 | 12 | \$ 7.32 |
| MW-SC16B | SYNRAY – Cut End – Narrow Band – 16 oz / 450 g / SYNRAY, à brins coupés, bande étroite, 16 oz / 450 g | 13 | 6 | 1.3 | 12 | \$ 8.82 |
| MW-SC20B | SYNRAY – Cut End – Narrow Band – 20 oz / 550 g / SYNRAY, à brins coupés, bande étroite, 20 oz / 550 g | 15 | 7 | 1.6 | 12 | \$ 10.38 |
| MW-SC24B | SYNRAY – Cut End – Narrow Band – 24 oz / 650 g / SYNRAY, à brins coupés, bande étroite, 24 oz / 650 g | 18 | 8 | 1.6 | 12 | \$ 11.74 |
| MW-SC28B | SYNRAY – Cut End – Narrow Band – 28 oz / 750 g / SYNRAY, à brins coupés, bande étroite, 28 oz / 750 g | 20 | 9 | 1.7 | 12 | \$ 13.69 |
| MW-SC32B | SYNRAY – Cut End – Narrow Band – 32 oz / 850 g / SYNRAY, à brins coupés, bande étroite, 32 oz / 850 g | 24 | 11 | 2.2 | 12 | \$ 15.21 |
| SYNRAY – CUT END – WIDE BAND – BAGGED / SYNRAY, À BRINS COUPÉS, BANDE LARGE, ENSACHÉ | | | | | | |
| MW-SC12WBB | SYNRAY – Cut End – Wide Band – 12 oz / 350 g / SYNRAY, à brins coupés, bande large, 12 oz / 350 g | 9 | 4 | 1.3 | 12 | \$ 9.15 |
| MW-SC16WBB | SYNRAY – Cut End – Wide Band – 16 oz / 450 g / SYNRAY, à brins coupés, bande large, 16 oz / 450 g | 13 | 6 | 1.3 | 12 | \$ 10.12 |
| MW-SC20WBB | SYNRAY – Cut End – Wide Band – 20 oz / 550 g / SYNRAY, à brins coupés, bande large, 20 oz / 550 g | 15 | 7 | 1.6 | 12 | \$ 11.91 |
| MW-SC24WBB | SYNRAY – Cut End – Wide Band – 24 oz / 650 g / SYNRAY, à brins coupés, bande large, 24 oz / 650 g | 18 | 8 | 1.6 | 12 | \$ 13.73 |
| MW-SC28WBB | SYNRAY – Cut End – Wide Band – 28 oz / 750 g / SYNRAY, à brins coupés, bande large, 28 oz / 750 g | 20 | 9 | 2.2 | 12 | \$ 15.42 |
| MW-SC32WBB | SYNRAY – Cut End – Wide Band – 32 oz / 850 g / SYNRAY, à brins coupés, bande large, 32 oz / 850 g | 24 | 11 | 2.2 | 12 | \$ 17.98 |

SYNRAY™ CHEATERS - CUT END WET MOPS / VADROUILLES SYNRAY™ CHEATERS - HUMIDES À BRINS COUPÉS



| SYNRAY - CUT END / BRINS COUPÉS | | | | | | | | | | |
|---------------------------------|---|---|---|---|---|---|---|---|---|----|
| | 1 | 2 | 3 | 4 | 5 | 6 | 7 | 8 | 9 | 10 |
| Durability / Durabilité | | | | | | | | | | |
| Absorbency / Absorption | | | | | | | | | | |
| Release / Capacité D'Évacuation | | | | | | | | | | |
| Launderability / Blanchiment | | | | | | | | | | |
| Performance / Performance | | | | | | | | | | |

| M2 Code Code M2 | Description | Pack Wt LB (S) Poids (lb) (S) | Pack Wt KG Poids (kg) | Cubic Ft Pi3 | Pack Contenu | List Price Liste des prix |
|--|---|----------------------------------|--------------------------|-----------------|-----------------|------------------------------|
| SYNRAY CHEATERS – CUT END – NARROW BAND – BAGGED / SYNRAY, À BRINS COUPÉS, BANDE ÉTROITE, ENSACHÉ | | | | | | |
| MW-SC16B# | SYNRAY – Cut End – Narrow Band – #16 / SYNRAY, à brins coupés, bande étroite, 16# | 13 | 6 | 1.3 | 12 | \$ 7.32 |
| MW-SC20B# | SYNRAY – Cut End – Narrow Band – 20# / SYNRAY, à brins coupés, bande étroite, 20# | 15 | 7 | 1.6 | 12 | \$ 8.82 |
| MW-SC24B# | SYNRAY – Cut End – Narrow Band – 24# / SYNRAY, à brins coupés, bande étroite, 24# | 18 | 8 | 1.6 | 12 | \$ 10.38 |
| MW-SC32B# | SYNRAY – Cut End – Narrow Band – 32# / SYNRAY, à brins coupés, bande étroite, 32# | 24 | 11 | 2.2 | 12 | \$ 11.74 |
| SYNRAY CHEATERS – CUT END – WIDE BAND – BAGGED / SYNRAY, À BRINS COUPÉS, BANDE LARGE, ENSACHÉ | | | | | | |
| MW-SC16WBB# | SYNRAY – Cut End – Wide Band – 16# / SYNRAY, à brins coupés, bande large, 16# | 13 | 6 | 1.3 | 12 | \$ 9.15 |
| MW-SC20WBB# | SYNRAY – Cut End – Wide Band – 20# / SYNRAY, à brins coupés, bande large, 20# | 15 | 7 | 1.6 | 12 | \$ 10.12 |
| MW-SC24WBB# | SYNRAY – Cut End – Wide Band – 24# / SYNRAY, à brins coupés, bande large, 24# | 18 | 8 | 1.6 | 12 | \$ 11.91 |
| MW-SC32WBB# | SYNRAY – Cut End – Wide Band – 32# / SYNRAY, à brins coupés, bande large, 32# | 24 | 11 | 2.2 | 12 | \$ 13.73 |



SYNRAY – FANTAIL – NARROW BAND – BAGGED / SYNRAY, ÉVENTAIL, BANDE ÉTROITE, ENSACHÉ



| SYNRAY - FANTAIL / ÉVENTAIL | | | | | | | | | | |
|---------------------------------|---|---|---|---|---|---|---|---|---|----|
| | 1 | 2 | 3 | 4 | 5 | 6 | 7 | 8 | 9 | 10 |
| Durability / Durabilité | | | | | | | | | | |
| Absorbency / Absorption | | | | | | | | | | |
| Release / Capacité D'Évacuation | | | | | | | | | | |
| Launderability / Blanchiment | | | | | | | | | | |
| Performance / Performance | | | | | | | | | | |

*Launderable but not highly recommended

| M2 Code Code M2 | Description | Pack Wt LB (S) Poids (lb) (S) | Pack Wt KG Poids (kg) | Cubic Ft Pi3 | Pack Contenu | List Price Liste des prix |
|---|---|----------------------------------|--------------------------|-----------------|-----------------|------------------------------|
| SYNRAY – FANTAIL – NARROW BAND – BAGGED / SYNRAY, ÉVENTAIL, BANDE ÉTROITE, ENSACHÉ | | | | | | |
| MW-SC12FTB | SYNRAY Fantail – Narrow Band – 12 oz / 350 g / SYNRAY, éventail, bande étroite, 12 oz / 350 g | 9 | 4 | 1 | 12 | \$ 9.56 |
| MW-SC16FTB | SYNRAY Fantail – Narrow Band – 16 oz / 450 g / SYNRAY, éventail, bande étroite, 16 oz / 450 g | 13 | 6 | 1.3 | 12 | \$ 9.91 |
| MW-SC20FTB | SYNRAY Fantail – Narrow Band – 20 oz / 550 g / SYNRAY, éventail, bande étroite, 20 oz / 550 g | 15 | 7 | 1.6 | 12 | \$ 11.61 |
| MW-SC24FTB | SYNRAY Fantail – Narrow Band – 24 oz / 650 g / SYNRAY, éventail, bande étroite, 24 oz / 650 g | 18 | 8 | 1.6 | 12 | \$ 13.30 |
| MW-SC32FTB | SYNRAY Fantail – Narrow Band – 32 oz / 850 g / SYNRAY, éventail, bande étroite, 32 oz / 850 g | 24 | 11 | 2.2 | 12 | \$ 16.59 |

SYNRAY – LOOPED – NARROW BAND – BAGGED / SYNRAY, À FRANGES BOUCLÉES, BANDE ÉTROITE, ENSACHÉ



| SYNRAY - LOOPED / FRANGES BOUCLÉES | | | | | | | | | | |
|------------------------------------|---|---|---|---|---|---|---|---|---|----|
| | 1 | 2 | 3 | 4 | 5 | 6 | 7 | 8 | 9 | 10 |
| Durability / Durabilité | | | | | | | | | | |
| Absorbency / Absorption | | | | | | | | | | |
| Release / Capacité D'Évacuation | | | | | | | | | | |
| Launderability / Blanchiment | | | | | | | | | | |
| Performance / Performance | | | | | | | | | | |

| M2 Code Code M2 | Description | Pack Wt LB (S) Poids (lb) (S) | Pack Wt KG Poids (kg) | Cubic Ft Pi3 | Pack Contenu | List Price Liste des prix |
|--|--|----------------------------------|--------------------------|-----------------|-----------------|------------------------------|
| SYNRAY – LOOPED – NARROW BAND – BAGGED / SYNRAY, À FRANGES BOUCLÉES, BANDE ÉTROITE, ENSACHÉ | | | | | | |
| MW-SL1S-NB | SYNRAY – Looped – Narrow Band – Small – Bagged / SYNRAY, à franges bouclées, bande étroite, petite, ensaché | 13 | 6 | 1.3 | 12 | \$ 9.40 |
| MW-SL2M-NB | SYNRAY – Looped – Narrow Band – Medium – Bagged / SYNRAY, à franges bouclées, bande étroite, moyenne, ensaché | 15 | 7 | 1.6 | 12 | \$ 11.00 |
| MW-SL3L-NB | SYNRAY – Looped – Narrow Band – Large – Bagged / SYNRAY, à franges bouclées, bande étroite, grande, ensaché | 18 | 8 | 1.6 | 12 | \$ 12.65 |
| MW-SL4XL-NB | SYNRAY – Looped – Narrow Band – X-Large – Bagged / SYNRAY, à franges bouclées, bande étroite, très grande, ensaché | 24 | 11 | 2.2 | 12 | \$ 18.85 |
| SYNRAY – LOOPED – WIDE BAND – BAGGED / SYNRAY, À FRANGES BOUCLÉES, BANDE LARGE, ENSACHÉ | | | | | | |
| MW-SL10S-WB | SYNRAY – Looped – Wide Band – Small – Bagged / SYNRAY, à franges bouclées, bande large, petite, ensaché | 13 | 6 | 1.3 | 12 | \$ 11.10 |
| MW-SL11M-WB | SYNRAY – Looped – Wide Band – Medium – Bagged / SYNRAY, à franges bouclées, bande large, moyenne, ensaché | 15 | 7 | 1.6 | 12 | \$ 12.99 |
| MW-SL12L-WB | SYNRAY – Looped – Wide Band – Large – Bagged / SYNRAY, à franges bouclées, bande large, grande, ensaché | 18 | 8 | 1.6 | 12 | \$ 14.98 |
| MW-SL13XL-WB | SYNRAY – Looped – Wide Band – X- Large – Bagged / SYNRAY, à franges bouclées, bande large, très grande, ensaché | 24 | 11 | 2.2 | 12 | \$ 21.91 |

COTTON-PRO™

CUT END & LOOPED WET MOPS

VADROUILLES HUMIDES À BRINS COUPÉS ET À FRANGES BOUCLÉES

| COTTON PRO - CUT END / BRINS COUPÉS | | | | | | | | | | |
|-------------------------------------|---|---|---|---|---|---|---|---|---|----|
| | 1 | 2 | 3 | 4 | 5 | 6 | 7 | 8 | 9 | 10 |
| Durability / Durabilité | ■ | ■ | ■ | ■ | ■ | ■ | ■ | ■ | ■ | ■ |
| Absorbency / Absorption | ■ | ■ | ■ | ■ | ■ | ■ | ■ | ■ | ■ | ■ |
| Release / Capacité D'Évacuation | ■ | ■ | ■ | ■ | ■ | ■ | ■ | ■ | ■ | ■ |
| Launderability / Blanchiment | ■ | ■ | ■ | ■ | ■ | ■ | ■ | ■ | ■ | ■ |
| Performance / Performance | ■ | ■ | ■ | ■ | ■ | ■ | ■ | ■ | ■ | ■ |

M2 uses a superior grade of 4 ply cotton yarn which requires less break-in. Our cotton mops can ideally be used for all purpose washing, scrubbing and stripping.

M2 se sert d'un tissu en coton, quatre fils, haut de gamme, qui requiert moins de préparation avant l'utilisation.

Nos vadrouilles en coton conviennent parfaitement au lavage, au récurage et au décapage généraux.

HEADBAND COLOURS ON COTTON MOPS / COULEURS DE LA BANDE DE TÊTE DE LA VADROUILLE EN COTON

12 OZ



350 g

16 OZ



450 g

20 OZ



550 g

24 OZ



650 g

32 OZ



850 g

| M2 Code Code M2 | Description | Pack Wt LB (S) Poids (lb) (S) | Pack Wt KG Poids (kg) | Cubic Ft Pi3 | Pack Contenu | List Price Liste des prix |
|---|---|----------------------------------|--------------------------|-----------------|-----------------|------------------------------|
| COTTON – CUT END – NARROW BAND – NO BAG / COTON, À BRINS COUPÉS, BANDE ÉTROITE, SANS SAC | | | | | | |
| MW-CC12 | Cotton – Cut End – Narrow Band– 12 oz / 350 g / Coton, à brins coupés, bande étroite, 12 oz / 350 g | 9 | 4 | 1 | 12 | \$ 5.44 |
| MW-CC16 | Cotton – Cut End – Narrow Band– 16 oz / 450 g / Coton, à brins coupés, bande étroite, 16 oz / 450 g | 13 | 6 | 1 | 12 | \$ 6.65 |
| MW-CC20 | Cotton – Cut End – Narrow Band– 20 oz / 550 g / Coton, à brins coupés, bande étroite, 20 oz / 550 g | 15 | 7 | 1.5 | 12 | \$ 7.86 |
| MW-CC24 | Cotton – Cut End – Narrow Band– 24 oz / 650 g / Coton, à brins coupés, bande étroite, 24 oz / 650 g | 18 | 8 | 1.5 | 12 | \$ 9.02 |
| MW-CC32 | Cotton – Cut End – Narrow Band– 32 oz / 850 g / Coton, à brins coupés, bande étroite, 32 oz / 850 g | 24 | 11 | 2 | 12 | \$ 12.02 |
| COTTON – CUT END – WIDE BAND – NO BAG / COTON, À BRINS COUPÉS, BANDE LARGE, SANS SAC | | | | | | |
| MW-CC12WB | Cotton – Cut End – Wide Band– 12 oz / 350 g / Coton, à brins coupés, bande large, 12 oz / 350 g | 13 | 6 | 1 | 12 | \$ 7.09 |
| MW-CC16WB | Cotton – Cut End – Wide Band– 16 oz / 450 g / Coton, à brins coupés, bande large, 16 oz / 450 g | 13 | 6 | 1 | 12 | \$ 8.30 |
| MW-CC20WB | Cotton – Cut End – Wide Band– 20 oz / 550 g / Coton, à brins coupés, bande large, 20 oz / 550 g | 15 | 7 | 1.5 | 12 | \$ 9.81 |
| MW-CC24WB | Cotton – Cut End – Wide Band– 24 oz / 650 g / Coton, à brins coupés, bande large, 24 oz / 650 g | 18 | 8 | 1.5 | 12 | \$ 11.31 |
| MW-CC32WB | Cotton – Cut End – Wide Band– 32 oz / 850 g / Coton, à brins coupés, bande large, 32 oz / 850 g | 24 | 11 | 2 | 12 | \$ 14.93 |



COTTON – CUT END – NARROW BAND – BAGGED / COTON, À BRINS COUPÉS, BANDE ÉTROITE, ENSACHÉ



| COTTON PRO - CUT END / BRINS COUPÉS | | | | | | | | | | |
|-------------------------------------|---|---|---|---|---|---|---|---|---|----|
| | 1 | 2 | 3 | 4 | 5 | 6 | 7 | 8 | 9 | 10 |
| Durability / Durabilité | | | | | | | | | | |
| Absorbency / Absorption | | | | | | | | | | |
| Release / Capacité D'Évacuation | | | | | | | | | | |
| Launderability / Blanchiment | | | | | | | | | | |
| Performance / Performance | | | | | | | | | | |

| COTTON PRO - FANTAIL / ÉVENTAIL | | | | | | | | | | |
|---------------------------------|---|---|---|---|---|---|---|---|---|----|
| | 1 | 2 | 3 | 4 | 5 | 6 | 7 | 8 | 9 | 10 |
| Durability / Durabilité | | | | | | | | | | |
| Absorbency / Absorption | | | | | | | | | | |
| Release / Capacité D'Évacuation | | | | | | | | | | |
| Launderability / Blanchiment | | | | | | | | | | |
| Performance / Performance | | | | | | | | | | |

*Launderable but not highly recommended

| M2 Code Code M2 | Description | Pack Wt LB (S) Poids (lb) (S) | Pack Wt KG Poids (kg) | Cubic Ft Pi3 | Pack Contenu | List Price Liste des prix |
|--|---|----------------------------------|--------------------------|-----------------|-----------------|------------------------------|
| COTTON – CUT END – NARROW BAND – BAGGED / COTON, À BRINS COUPÉS, BANDE ÉTROITE, ENSACHÉ | | | | | | |
| MW-CC12B | Cotton – Cut End – Narrow Band – 12 oz / 350 g - Bagged / Coton, bande étroite, 12 oz / 350 g - ensaché | 9 | 4 | 1 | 12 | \$ 6.43 |
| MW-CC16B | Cotton – Cut End – Narrow Band – 16 oz / 450 g - Bagged / Coton, bande étroite, 16 oz / 450 g - ensaché | 13 | 6 | 1 | 12 | \$ 7.76 |
| MW-CC20B | Cotton – Cut End – Narrow Band – 20 oz / 550 g - Bagged / Coton, bande étroite, 20 oz / 550 g - ensaché | 15 | 7 | 1.5 | 12 | \$ 9.13 |
| MW-CC24B | Cotton – Cut End – Narrow Band – 24 oz / 650 g - Bagged / Coton, bande étroite, 24 oz / 650 g - ensaché | 18 | 8 | 1.5 | 12 | \$ 10.43 |
| MW-CC32B | Cotton – Cut End – Narrow Band – 32 oz / 850 g - Bagged / Coton, bande étroite, 32 oz / 850 g - ensaché | 24 | 11 | 2 | 12 | \$ 13.80 |
| COTTON – CUT END – WIDE BAND – BAGGED / COTON, À BRINS COUPÉS, BANDE LARGE, ENSACHÉ | | | | | | |
| MW-CC12WBB | Cotton – Cut End – Wide Band – 12 oz / 350 g - Bagged / Coton, à brins coupés, bande large, 12 oz / 350 g - ensaché | 13 | 6 | 1 | 12 | \$ 8.29 |
| MW-CC16WBB | Cotton – Cut End – Wide Band – 16 oz / 450 g - Bagged / Coton, à brins coupés, bande large, 16 oz / 450 g - ensaché | 13 | 6 | 1 | 12 | \$ 9.64 |
| MW-CC20WBB | Cotton – Cut End – Wide Band – 20 oz / 550 g - Bagged / Coton, à brins coupés, bande large, 20 oz / 550 g - ensaché | 15 | 7 | 1.5 | 12 | \$ 11.34 |
| MW-CC24WBB | Cotton – Cut End – Wide Band – 24 oz / 650 g - Bagged / Coton, à brins coupés, bande large, 24 oz / 650 g - ensaché | 18 | 8 | 1.5 | 12 | \$ 13.02 |
| MW-CC32WBB | Cotton – Cut End – Wide Band – 32 oz / 850 g - Bagged / Coton, à brins coupés, bande large, 32 oz / 850 g - ensaché | 24 | 11 | 2 | 12 | \$ 17.08 |
| COTTON – FANTAIL – NARROW BAND – BAGGED / COTON, ÉVENTAIL, BANDE ÉTROITE, ENSACHÉ | | | | | | |
| MW-CC16FTB | Cotton – Fantail – NB – 16 oz / 450 g - Bagged / Coton, à franges bouclées, bande étroite, 16 oz / 450 g - ensaché | 13 | 6 | 1 | 12 | \$ 9.00 |
| MW-CC20FTB | Cotton – Fantail – NB – 20 oz / 550 g - Bagged / Coton, à franges bouclées, bande étroite, 20 oz / 550 g - ensaché | 15 | 7 | 1.5 | 12 | \$ 10.76 |
| MW-CC24FTB | Cotton – Fantail – NB – 24 oz / 650 g - Bagged / Coton, à franges bouclées, bande étroite, 24 oz / 650 g - ensaché | 18 | 8 | 1.5 | 12 | \$ 12.39 |
| MW-CC32FTB | Cotton – Fantail – NB – 32 oz / 850 g - Bagged / Coton, à franges bouclées, bande étroite, très 32 oz / 850 g - ensaché | 24 | 11 | 2 | 12 | \$ 15.75 |

COTTON – LOOPED – NARROW BAND – BAGGED / COTON, À FRANGES BOUCLÉES, BANDE ÉTROITE, ENSACHÉ



| COTTON PRO - LOOPED / FRANGES BOUCLÉES | | | | | | | | | | |
|--|---|---|---|---|---|---|---|---|---|----|
| | 1 | 2 | 3 | 4 | 5 | 6 | 7 | 8 | 9 | 10 |
| Durability / Durabilité | | | | | | | | | | |
| Absorbency / Absorption | | | | | | | | | | |
| Release / Capacité D'Évacuation | | | | | | | | | | |
| Launderability / Blanchiment | | | | | | | | | | |
| Performance / Performance | | | | | | | | | | |

| M2 Code Code M2 | Description | Pack Wt LB (S) Poids (lb) (S) | Pack Wt KG Poids (kg) | Cubic Ft Pi3 | Pack Contenu | List Price Liste des prix |
|---|---|----------------------------------|--------------------------|-----------------|-----------------|------------------------------|
| COTTON – LOOPED – NARROW BAND – BAGGED / COTON, À FRANGES BOUCLÉES, BANDE ÉTROITE, ENSACHÉ | | | | | | |
| MW-CL15-NB | Cotton – Looped – Narrow Band – Small – Bagged / Coton, à franges bouclées, bande étroite, petite, ensaché | 13 | 6 | 1.3 | 12 | \$ 89.78 |
| MW-CL2M-NB | Cotton – Looped – Narrow Band – Medium – Bagged / Coton, à franges bouclées, bande étroite, moyenne, ensaché | 15 | 6.8 | 1.6 | 12 | \$ 12.08 |
| MW-CL3L-NB | Cotton – Looped – Narrow Band – Large – Bagged / Coton, à franges bouclées, bande étroite, grande, ensaché | 18 | 8 | 1.6 | 12 | \$ 13.91 |
| MW-CL4XL-NB | Cotton – Looped – Narrow Band – X-Large – Bagged / Coton, à franges bouclées, bande étroite, très grande, ensaché | 24 | 10.8 | 2 | 12 | \$ 17.04 |
| COTTON – LOOPED – WIDE BAND – BAGGED / COTON, À FRANGES BOUCLÉES, BANDE LARGE, ENSACHÉ | | | | | | |
| MW-CL10S-WB | Cotton – Looped – Wide Band – Small – Bagged / Coton, à franges bouclées, bande large, petite, ensaché | 13 | 6 | 1.3 | 12 | \$ 11.63 |
| MW-CL11M-WB | Cotton – Looped – Wide Band – Medium – Bagged / Coton, à franges bouclées, bande large, moyenne, ensaché | 15 | 6.8 | 1.6 | 12 | \$ 14.28 |
| MW-CL12L-WB | Cotton – Looped – Wide Band – Large – Bagged / Coton, à franges bouclées, bande large, grande, ensaché | 18 | 8 | 1.6 | 12 | \$ 16.48 |
| MW-CL13XL-WB | Cotton – Looped – Wide Band – X-Large – Bagged / Coton, à franges bouclées, bande large, très grande, ensaché | 24 | 10.8 | 2.2 | 12 | \$ 20.41 |

COTTON PRO™ CHEATERS - CUT END WET MOPS / VADROUILLES COTTON PRO™ CHEATERS - HUMIDES À BRINS COUPTÉS



| COTTON PRO - CUT END / BRINS COUPTÉS | | | | | | | | | | |
|--------------------------------------|---|---|---|---|---|---|---|---|---|----|
| | 1 | 2 | 3 | 4 | 5 | 6 | 7 | 8 | 9 | 10 |
| Durability / Durabilité | | | | | | | | | | |
| Absorbency / Absorption | | | | | | | | | | |
| Release / Capacité D'Évacuation | | | | | | | | | | |
| Launderability / Blanchiment | | | | | | | | | | |
| Performance / Performance | | | | | | | | | | |

| M2 Code Code M2 | Description | Pack Wt LB (S) Poids (lb) (S) | Pack Wt KG Poids (kg) | Cubic Ft Pi3 | Pack Contenu | List Price Liste des prix |
|---|---|----------------------------------|--------------------------|-----------------|-----------------|------------------------------|
| COTTON PRO – CUT END – NARROW BAND – NO BAG/ COTON PRO, À BRINS COUPTÉS, BANDE ÉTROITE, ENSACHÉ | | | | | | |
| MW-CC16# | Cotton – Cut End – Narrow Band – 16# - No Bag / Coton, bande étroite, bande étroite, 16# - Ensaché | 13 | 6 | 1 | 12 | \$ 6.09 |
| MW-CC20# | Cotton – Cut End – Narrow Band – 20# - No Bag / Coton, bande étroite, bande étroite, 20# - Ensaché | 15 | 7 | 1.5 | 12 | \$ 7.46 |
| MW-CC24# | Cotton – Cut End – Narrow Band – 24# - No Bag / Coton, bande étroite, bande étroite, 24# - Ensaché | 18 | 8 | 1.5 | 12 | \$ 8.82 |
| MW-CC32# | Cotton – Cut End – Narrow Band – 32# - No Bag / Coton, à brins coupés, bande étroite, 32# - Ensaché | 24 | 11 | 2 | 12 | \$ 10.14 |
| COTTON PRO – CUT END – NARROW BAND – BAGGED / COTON PRO, À BRINS COUPTÉS, BANDE ÉTRUITE, ENSACHÉ | | | | | | |
| MW-CC16B# | Cotton – Cut End – Narrow Band – 16# - Bagged/ Coton, bande étroite, bande étroite, 16# - Ensaché | 13 | 6 | 1 | 12 | \$ 6.43 |
| MW-CC20B# | Cotton – Cut End – Narrow Band – 20# - Bagged/ Coton, bande étroite, bande étroite, 20# - Ensaché | 15 | 7 | 1.5 | 12 | \$ 7.76 |
| MW-CC24B# | Cotton – Cut End – Narrow Band – 24# - Bagged/ Coton, bande étroite, bande étroite, 24# - Ensaché | 18 | 8 | 1.5 | 12 | \$ 9.13 |
| MW-CC32B# | Cotton – Cut End – Narrow Band – 32# - Bagged/ Coton, bande étroite, bande étroite, 32# - Ensaché | 24 | 11 | 2 | 12 | \$ 10.43 |
| COTTON PRO – CUT END – WIDE BAND – BAGGED / COTON PRO, À BRINS COUPTÉS, BANDE LARGE, ENSACHÉ | | | | | | |
| MW-CC16WBB# | Cotton – Cut End – Wide Band – 16# - Bagged/ Coton, à brins coupés, bande large, 16# - Ensaché | 13 | 6 | 1 | 12 | \$ 8.29 |
| MW-CC20WBB# | Cotton – Cut End – Wide Band – 20# - Bagged/ Coton, à brins coupés, bande large, 20# - Ensaché | 15 | 7 | 1.5 | 12 | \$ 9.64 |
| MW-CC24WBB# | Cotton – Cut End – Wide Band – 24# - Bagged/ Coton, à brins coupés, bande large, 24# - Ensaché | 18 | 8 | 1.5 | 12 | \$ 11.34 |
| MW-CC32WBB# | Cotton – Cut End – Wide Band – 32# - Bagged/ Coton, à brins coupés, bande large, 32# - Ensaché | 24 | 11 | 2 | 12 | \$ 13.02 |

VALUE ECONOMY MOPS / VADROUILLES ÉCONOMIQUES



| VALUE ECONOMY - LOOPED / FRANGES BOUCLÉES | | | | | | | | | | |
|---|---|---|---|---|---|---|---|---|---|----|
| | 1 | 2 | 3 | 4 | 5 | 6 | 7 | 8 | 9 | 10 |
| Durability / Durabilité | | | | | | | | | | |
| Absorbency / Absorption | | | | | | | | | | |
| Release / Capacité D'Évacuation | | | | | | | | | | |
| Launderability / Blanchiment | | | | | | | | | | |
| Performance / Performance | | | | | | | | | | |

| VALUE ECONOMY - CUT END / BRINS COUPTÉS | | | | | | | | | | |
|---|---|---|---|---|---|---|---|---|---|----|
| | 1 | 2 | 3 | 4 | 5 | 6 | 7 | 8 | 9 | 10 |
| Durability / Durabilité | | | | | | | | | | |
| Absorbency / Absorption | | | | | | | | | | |
| Release / Capacité D'Évacuation | | | | | | | | | | |
| Launderability / Blanchiment | | | | | | | | | | |
| Performance / Performance | | | | | | | | | | |

* Launderable but not highly recommended
* Lavable mais pas fortement recommandé

| M2 Code Code M2 | Description | Pack Wt LB (S) Poids (lb) (S) | Pack Wt KG Poids (kg) | Cubic Ft Pi3 | Pack Contenu | List Price Liste des prix |
|--|---|----------------------------------|--------------------------|-----------------|-----------------|------------------------------|
| VALUE ECONOMY CUT END - NARROW BAND - BAGGED / VADROUILLE QUALITÉ ÉCONOMIQUE - BOUT COUPE - BANDE ÉTROITE - bleu - ENSACHÉE | | | | | | |
| MW-VEC16B-BL | Value Economy – Cut End – NB – 16 oz / 450 g - Bagged - Blue / Vadrouille de qualité économique bout coupé - Bande étroite - bleue - Ensachée 16 oz / 450 g | 13 | 6 | 1 | 12 | \$ 9.05 |
| MW-VEC20B-BL | Value Economy – Cut End – NB – 20 oz / 550 g - Bagged - Blue / Vadrouille de qualité économique bout coupé - Bande étroite - bleue - Ensachée 20 oz / 550 g | 15 | 7 | 1.5 | 12 | \$ 10.56 |
| MW-VEC24B-BL | Value Economy – Cut End – NB – 24 oz / 650 g - Bagged - Blue / Vadrouille de qualité économique bout coupé - Bande étroite - bleue - Ensachée 24 oz / 650 g | 18 | 8 | 1.5 | 12 | \$ 12.07 |
| MW-VEC32B-BL | Value Economy – Cut End – NB – 32 oz / 850 g - Bagged - Blue / Vadrouille de qualité économique bout coupé - Bande étroite - bleue - Ensachée 32 oz / 850 g | 24 | 11 | 2 | 12 | \$ 16.61 |
| VALUE ECONOMY LOOPED END - NARROW BAND - BLUE / VADROUILLE QUALITÉ ÉCONOMIQUE - POIDS RÉEL - EXTRÉMITÉS BOUCLÉS BANDE ÉTROITE | | | | | | |
| MW-VEL16-NB-BL | Value Economy – Looped End – NB – 16 oz / 450 g - Blue / Vadrouille qualité économique - Poids réel - Extrémités bouclés - bleue - Ensachée 16 oz / 450 g | 15 | 6.8 | 1.6 | 12 | \$ 9.69 |
| MW-VEL20-NB-BL | Value Economy – Looped End – NB – 20 oz / 550 g - Blue / Vadrouille qualité économique - Poids réel - Extrémités bouclés - bleue - Ensachée 20 oz / 550 g | 18 | 8 | 1.6 | 12 | \$ 11.07 |
| MW-VEL24-NB-BL | Value Economy – Looped End – NB – 24 oz / 650 g - Bagged - Blue / Vadrouille qualité économique - Poids réel - Extrémités bouclés - bleue - 24 oz / 650 g | 24 | 10.8 | 2.2 | 12 | \$ 12.46 |



VALUE ECONOMY R-BLEND MOPS /

- Ideal for Foodservice
- Low usage

- Idéal pour les services alimentaires
- Travaux légers



HEADBAND COLOURS ON ECONOMY MOPS / COULEURS DE BANDE SUR LES VADROUILLES ÉCONOMIQUES



| M2 Code Code M2 | Description | Pack Wt LB (S) Poids (lb) (S) | Pack Wt KG Poids (kg) | Cubic Ft Pi3 | Pack Contenu | List Price Liste des prix |
|---|--|----------------------------------|--------------------------|-----------------|-----------------|------------------------------|
| VALUE ECONOMY COTTON CUT END - NARROW BAND / - VADROUILLE DE COTON QUALITÉ ÉCONOMIQUE - BANDE ÉTROITE - ENSACHÉE | | | | | | |
| MW-VCC12B | Value Economy Cotton – Cut End – NB– 12 oz / 350 g - Bagged / Vadrouille de coton qualité économique - Bande étroite - Ensachée 12 oz / 350 g | 9 | 4 | 1 | 12 | \$ 5.84 |
| MW-VCC16B | Value Economy Cotton – Cut End – NB– 16 oz / 450 g - Bagged / Vadrouille de coton qualité économique - Bande étroite - Ensachée 16 oz / 450 g | 13 | 6 | 1 | 12 | \$ 7.05 |
| MW-VCC20B | Value Economy Cotton – Cut End – NB– 20 oz / 550 g - Bagged / Vadrouille de coton qualité économique - Bande étroite - Ensachée 20 oz / 550 g | 15 | 7 | 1.5 | 12 | \$ 8.31 |
| MW-VCC24B | Value Economy Cotton – Cut End – NB– 24 oz / 650 g - Bagged / Vadrouille de coton qualité économique - Bande étroite - Ensachée 24 oz / 650 g | 18 | 8 | 1.5 | 12 | \$ 9.49 |
| MW-VCC32B | Value Economy Cotton – Cut End – NB– 32 oz / 850 g - Bagged / Vadrouille de coton qualité économique - Bande étroite - Ensachée 32 oz / 850 g | 24 | 11 | 2 | 12 | \$ 12.55 |
| VALUE ECONO-RAY CUT END - NARROW BAND - BAGGED / | | | | | | |
| MW-VEC12B-CA | Econo-Ray – Cut End – NB- 12 oz / 350 g - Bagged / Vadrouille de qualité économique - Bande étroite - Ensachée 2 oz / 350 g | 13 | 6 | 1 | 12 | \$ 6.78 |
| MW-VEC16B-CA | Econo-Ray – Cut End – NB- 16 oz / 450 g - Bagged / Vadrouille de qualité économique - Bande étroite - Ensachée 16 oz / 450 g | 13 | 6 | 1 | 12 | \$ 7.05 |
| MW-VEC20B-CA | Econo-Ray – Cut End – NB- 20 oz / 550 g - Bagged / Vadrouille de qualité économique - Bande étroite - Ensachée 20 oz / 550 g | 15 | 7 | 1.5 | 12 | \$ 8.23 |
| MW-VEC24B-CA | Econo-Ray – Cut End – NB- 24 oz / 650 g - Bagged / Vadrouille de qualité économique - Bande étroite - Ensachée 24 oz / 650 g | 18 | 8 | 1.5 | 12 | \$ 9.41 |
| MW-VECE32B-CA | Econo-Ray – Cut End – NB- 32 oz / 850 g - Bagged / Vadrouille de qualité économique - Bande étroite - Ensachée 32 oz / 850 g | 24 | 11 | 2 | 12 | \$ 12.94 |

LAYFLAT STYLE MOPS /



| M2 Code Code M2 | Description | Pack Wt LB (S) Poids (lb) (S) | Pack Wt KG Poids (kg) | Cubic Ft Pi3 | Pack Contenu | List Price Liste des prix |
|--|--|----------------------------------|--------------------------|-----------------|-----------------|------------------------------|
| LAYFLAT STYLE COTTON MOPS NARROW BAND-BAGGED / BANDE ÉTROITE ENSACHÉ | | | | | | |
| MW-LFC16B | 16oz/450g LayFlat Style Cotton - Bagged / Vadrouille Rayon bouts coupés, bande étroite 16 oz/450 g ensachée/vissée | 13 | 6 | 1 | 12 | \$11.50 |
| MW-LFC20B | 20oz/550g LayFlat Style Cotton - Bagged / Vadrouille Rayon bouts coupés, bande étroite 20 oz/550 g ensachée/vissée | 15 | 7 | 1.5 | 12 | \$ 12.90 |
| MW-LFC24B | 24oz/650g LayFlat Style Cotton - Bagged / Vadrouille Rayon bouts coupés, bande étroite 24 oz/650 g ensachée/vissée | 18 | 8 | 1.5 | 12 | \$ 14.73 |
| LAYFLAT STYLE RAYON (WHITE)NARROW BAND-BAGGED / BANDE ÉTROITE ENSACHÉ | | | | | | |
| MW-LFR16B | 16oz/450g LayFlat Style Rayon White - Bagged / Vadrouille Rayon bouts coupés, bande étroite 16 oz/450 g ensachée/vissée - blanc | 13 | 6 | 1 | 12 | \$ 12.99 |
| MW-LFR20B | 20oz/550g LayFlat Style Rayon White - Bagged / Vadrouille Rayon bouts coupés, bande étroite 20 oz/550 g ensachée/vissée - blanc | 15 | 7 | 1.5 | 12 | \$ 15.01 |
| MW-LFR24B | 24oz/650g LayFlat Style Rayon White - Bagged / Vadrouille Rayon bouts coupés, bande étroite 24 oz/650 g ensachée/vissée - blanc | 18 | 8 | 1.5 | 12 | \$ 16.98 |

LAYFLAT STYLE MOPS /



| M2 Code Code M2 | Description | Pack Wt LB (S) Poids (lb) (S) | Pack Wt KG Poids (kg) | Cubic Ft Pi3 | Pack Contenu | List Price Liste des prix |
|---|--|----------------------------------|--------------------------|-----------------|-----------------|------------------------------|
| LAYFLAT STYLE COTTON MOPS NARROW BAND-BAGGED / BANDE ÉTROITE ENSACHÉ | | | | | | |
| MW-LFB16BB | 16oz/450g LayFlat Style BlueBlend - Bagged / Vadrouille Rayon bouts coupés, bande étroite 16 oz/650 g ensachée/vissée - bleu | 13 | 6 | 1 | 12 | \$12.36 |
| MW-LFB20BB | 20oz/550g LayFlat Style BlueBlend - Bagged / Vadrouille Rayon bouts coupés, bande étroite 20 oz/550 g ensachée/vissée - bleu | 15 | 7 | 1.5 | 12 | \$ 14.55 |
| MW-LFB24BB | 24oz/650g LayFlat Style BlueBlend - Bagged / Vadrouille Rayon bouts coupés, bande étroite 24 oz/650 g ensachée/vissée - bleu | 18 | 8 | 1.5 | 12 | \$ 16.62 |



CANDYSTRIPE WAXER™ LOOPED END MOP / CANDYSTRIPE WAXER™ À FRANGES BOUCLÉES

| CANDYSTRIPE WAXER - LOOPED / FRANGES BOUCLÉES | | | | | | | | | | |
|---|---|---|---|---|---|---|---|---|---|----|
| | 1 | 2 | 3 | 4 | 5 | 6 | 7 | 8 | 9 | 10 |
| Durability/ Durabilité | | | | | | | | | | |
| Absorbency/ Absorption | | | | | | | | | | |
| Release/ Capacité d'Évacuation | | | | | | | | | | |
| Launderability/ Blanchiment | | | | | | | | | | |
| Performance/ Performance | | | | | | | | | | |



HARDSTRING FINISHER NB CUT END / HARDSTRING FINISSEUR BANDE ÉTROITE BOUT COUPÉ

| HARDSTRING - CUT END / BRINS COUPÉS | | | | | | | | | | |
|-------------------------------------|---|---|---|---|---|---|---|---|---|----|
| | 1 | 2 | 3 | 4 | 5 | 6 | 7 | 8 | 9 | 10 |
| Durability/ Durabilité | | | | | | | | | | |
| Absorbency/ Absorption | | | | | | | | | | |
| Release/ Capacité d'Évacuation | | | | | | | | | | |
| Launderability/ Blanchiment | | | | | | | | | | |
| Performance/ Performance | | | | | | | | | | |

| M2 Code Code M2 | Description | Pack Wt LB (S) Poids (lb) (S) | Pack Wt KG Poids (kg) | Cubic Ft Pi3 | Pack Contenu | List Price Liste des prix |
|--------------------|---|----------------------------------|--------------------------|-----------------|-----------------|------------------------------|
| MW-CS16 | CandyStripe Waxer floor mop - Narrow Band - Looped End - Small / CandyStripe Waxer vadrouille - à franges bouclées -Bande étroite - Petit | 13 | 6 | 1.3 | 12 | \$ 14.42 |
| MW-CS20 | CandyStripe Waxer floor mop - Narrow Band - Looped End Medium / CandyStripe Waxer vadrouille - à franges bouclées -Bande étroite - Moyen | 15 | 7 | 1.6 | 12 | \$ 16.72 |
| MW-CS24 | CandyStripe Waxer floor mop - Narrow Band - Looped End Large / CandyStripe Waxer vadrouille - à franges bouclées -Bande étroite - Grand | 15 | 7 | 1.6 | 12 | \$ 19.39 |
| MW-HS16B | HardString Finisher - Narrow Band - 16 oz / 450 g Bagged / HardString Finisseur - Bande étroite-16 oz / 450 g avec sac | 13 | 6 | 1.3 | 12 | \$ 16.67 |
| MW-HS20B | HardString Finisher - Narrow Band - 20 oz / 550 g Bagged / HardString Finisseur - Bande étroite-16 oz / 550 g avec sac | 15 | 7 | 1.6 | 12 | \$ 19.60 |
| MW-HS24B | HardString Finisher - Narrow Band - 24 oz / 650 g Bagged / HardString Finisseur - Bande étroite-16 oz / 650 g avec sac | 15 | 7 | 1.6 | 12 | \$ 22.60 |

GLACIER NYLON FLOOR & WAXING MOP /VADROUILLES POUR LAVAGE ET CIRAGE DE PLANCHER GLACIER



For use with Dust Clipper Frame / À utiliser avec le Cadre "Clipper"

- Easily slides across floor reducing worker fatigue
- Recommended for buffing high gloss surfaces
- Less waste at end of task
- Glisse facilement sur le sol en réduisant la fatigue du travailleur
- Recommandé pour usage sur des surfaces polies
- Moins de déchets à la fin de la tâche

| GLACIER - LOOPED / FRANGES BOUCLÉES | | | | | | | | | | |
|-------------------------------------|---|---|---|---|---|---|---|---|---|----|
| | 1 | 2 | 3 | 4 | 5 | 6 | 7 | 8 | 9 | 10 |
| Durability/ Durabilité | | | | | | | | | | |
| Absorbency/ Absorption | | | | | | | | | | |
| Release/ Capacité d'Évacuation | | | | | | | | | | |
| Launderability/ Blanchiment | | | | | | | | | | |
| Performance/ Performance | | | | | | | | | | |

| M2 Code Code M2 | Description | Pack Wt LB (S) Poids (lb) (S) | Pack Wt KG Poids (kg) | Cubic Ft Pi3 | Pack Contenu | List Price Liste des prix |
|---|--|----------------------------------|--------------------------|-----------------|-----------------|------------------------------|
| MW-W16 | Glacier White Waxer - Nylon Floor Mop - NB- 16 oz / Lave-sol, blanc glacier nylon à bande étroite sans peluche, 16 oz | 13 | 6 | 1.3 | 12 | \$ 22.95 |
| MW-W20 | Glacier White Waxer - Nylon Floor Mop - NB- 20 oz / Lave-sol, blanc glacier nylon à bande étroite sans peluche, 20 oz | 15 | 7 | 1.6 | 12 | \$ 25.69 |
| MW-W24 | Glacier White Waxer - Nylon Floor Mop - NB- 24 oz / Lave-sol, blanc glacier nylon à bande étroite sans peluche, 24 oz | 15 | 7 | 1.6 | 12 | \$ 30.70 |
| MW-W32 | Glacier White Waxer - Nylon Floor Mop - NB- 32 oz / Lave-sol, blanc glacier nylon à bande étroite sans peluche, 32 oz | 16 | 7.5 | 2 | 12 | \$ 40.55 |
| GLACIER NYLON FINISHING MOP / VADROUILLES À POUSSIÈRE EN NYLON "GLACIER" | | | | | | |
| DM-W518 | Glacier Nylon Finishing Mops - 5" x 18" / 13 x 46 cm - Tie-on / Vadrouilles à poussière en nylon "Glacier", 5 x 18"/46 cm x 13 cm - Attacher | 9.5 | 4.3 | | 12 | \$ 40.46 |
| DM-WV518 | Glacier Nylon Velcro MopPad - 5" x 18" / 13 x 46 cm / Vadrouilles à poussière en nylon avec Velcro "Glacier", 5 x 18"/46 cm x 13 cm | 9.5 | 4.3 | | 12 | \$ 23.62 |



SUPERSORB MADE FROM 100% RE-PURPOSED POST-INDUSTRIAL NON-WOVEN MATERIALS / FABRIQUÉ À PARTIR DE MATÉRIAUX NON TISSÉS 100% RECYCLÉ APRÈS INDUSTRIALISATION.



**ABSORBE
7 FOIS
SON POIDS**

| SUPERSORB- LOOPED / FRANGES BOUCLÉES | | | | | | | | | | |
|--------------------------------------|---|---|---|---|---|---|---|---|---|----|
| | 1 | 2 | 3 | 4 | 5 | 6 | 7 | 8 | 9 | 10 |
| Durability / Durabilité | | | | | | | | | | |
| Absorbency / Absorption | | | | | | | | | | |
| Release / Capacité D'Évacuation | | | | | | | | | | |
| Launderability / Blanchiment | | | | | | | | | | |
| Performance / Performance | | | | | | | | | | |

* Not recommended for laundering /
* Non recommandé pour le blanchissage

- Most suitable in areas where a large absorption of liquid is required
- Ideal for oil and solvents
- Can also be used on rough surface floors

- Le plus approprié dans les zones où une grande absorption du liquide est exigée
- Grandiose pour ramasser les déversements
- Idéal pour les huiles et solvants

| M2 Code | Description | Pack Wt LB (S) | Pack Wt KG | Cubic Ft | Pack | List Price |
|------------|---|----------------|------------|----------|---------|----------------|
| Code M2 | | Poids (lb) (S) | Poids (kg) | Pi3 | Contenu | Liste des prix |
| MW-SS11920 | SuperSorb Spill Mop - Medium / Vadrouille moyenne pour surface rugueuse - Moyen | | | | 12 | \$ 12.38 |
| MW-SS11924 | SuperSorb Spill Mop - Large / Vadrouille moyenne pour surface rugueuse - Grand | | | | 12 | \$ 14.03 |

ROUGH SURFACE MOP / VAIDROUILLE MOYENNE POUR SURFACE RUGUEUSE



| ROUGH SURFACE MOP / POUR SURFACE RUGUEUSE | | | | | | | | | | |
|---|---|---|---|---|---|---|---|---|---|----|
| Wet Mop Version | | | | | | | | | | |
| | 1 | 2 | 3 | 4 | 5 | 6 | 7 | 8 | 9 | 10 |
| Durability / Durabilité | | | | | | | | | | |
| Absorbency / Absorption | | | | | | | | | | |
| Release / Capacité D'Évacuation | | | | | | | | | | |
| Launderability / Blanchiment | | | | | | | | | | |
| Performance / Performance | | | | | | | | | | |

| | | | | | | |
|--------------|--|--|--|--|------|----------|
| MW-RF2090 | Rough Surface Mop – Medium - Yellow / Vadrouille moyenne pour surface rugueuse-jaune | | | | 6/1 | \$ 23.12 |
| YM-Y412 | Detachable Ruff Surface Yacht Mop – Cut End – Small - Yellow / Petite vadrouille "Yacht" à bouts coupés, détachable, pour surface rugueuse | | | | 12/1 | \$ 15.62 |
| YM-Y412-M348 | Detachable Ruff Surface Yacht Mop – Cut End – Small - Yellow with 48" metal handle / Petite vadrouille "Yacht" à bouts coupés, détachable, pour surface rugueuse - manche de métal 48" | | | | 12/1 | \$ 18.82 |

MAC MOP - IDEAL FOR FOODSERVICE / VAIDROUILLE MAC - IDÉALE POUR SERVICE D'ALIMENTATION



| MAC MOP - LOOPED / FRANGES BOUCLÉES | | | | | | | | | | |
|-------------------------------------|---|---|---|---|---|---|---|---|---|----|
| | 1 | 2 | 3 | 4 | 5 | 6 | 7 | 8 | 9 | 10 |
| Durability / Durabilité | | | | | | | | | | |
| Absorbency / Absorption | | | | | | | | | | |
| Release / Capacité D'Évacuation | | | | | | | | | | |
| Launderability / Blanchiment | | | | | | | | | | |
| Performance / Performance | | | | | | | | | | |

| | | | | | | |
|---------|---|--|--|--|----|----------|
| MW-BM16 | 16 oz/450g Mac Mop Looped - NB – Bagged - Orange/Yellow / Mac Mop à brins coupés, 16oz.450g, bande étroite, Ensaché | | | | 12 | \$ 17.41 |
| MW-BM20 | 20 oz/550g Mac Mop Looped - NB – Bagged - Orange/Yellow/ Mac, à brins coupés, 20oz/550g, bande étroite, Ensaché | | | | 12 | \$ 19.63 |
| MW-BM24 | 24 oz/650g Mac Mop Looped - NB – Bagged Orange/Yellow / Mac, à brins coupés, 24oz/650g, bande étroite, Ensaché | | | | 12 | \$ 22.58 |

MICROFIBER TUBE LOOPED MOPS / VAIDROUILLE EN MICROFIBER BOUCLÉE



| | | | | | | |
|----------|--|--|--|--|-------|----------|
| MW-TM396 | Medium Microfiber Tube Looped Mop WB - Green | | | | 24/12 | \$ 31.28 |
| MW-TM600 | Large Microfiber Tube Looped Mop WB - Blue | | | | 20/10 | \$ 47.02 |

MICROFIBER LOOPED MOP - NARROW BAND



| M2 Code Code M2 | Description | Pack Wt LB (S) Poids (lb) (S) | Pack Wt KG Poids (kg) | Cubic Ft Pi3 | Pack Contenu | List Price Liste des prix |
|---|---|----------------------------------|--------------------------|-----------------|-----------------|------------------------------|
| MICROFIBER LOOPED MOP NARROW BAND - BLUE, RED, YELLOW, GREEN | | | | | | |
| MW-MM16-BL | 16oz/450g MicroFiber Mop - NBand Looped – NB Bagged - Blue,Red,Yellow,Green | 13 | 6 | 1.3 | 12 | \$ 21.14 |
| MW-MM20-BL | 20oz/550g MicroFiber Mop - NBand Looped – NB Bagged - Blue | 15 | 7 | 1.6 | 12 | \$ 24.07 |
| MW-MM24-BL | 24oz/650g MicroFiber Mop - NBand Looped – NB Bagged - Blue | 15 | 7 | 1.6 | 12 | \$ 27.68 |
| MW-MM32-BL | 32oz/850g MicroFiber Mop - NBand Looped – NB Bagged - Blue,Red,Yellow,Green | 16 | 7.5 | 2 | 12 | \$ 34.84 |
| MW-MM20-RD | 20oz/550g MicroFiber Mop NBand Looped mop Bagged-Red | 9.5 | 4.3 | | 12 | \$ 24.07 |
| MW-MM24-RD | 24oz/650g MicroFiber Mop NBand Looped mop 20oz/550g Bagged-Red | 9.5 | 4.3 | | 12 | \$ 27.68 |

ALL-IN-ONE PROMOP COMBOS / ENSEMBLE TOU-EN-UN PROMOP

PROMOP COMBO SYNRAY - NARROW BAND WITH 60" SNAP-N-GO METAL HANDLE



PROMOP COMBO SWINGER MEDIUM NARROW BAND WITH 60" SNAP-N-GO METAL HANDLE



PROMOP COMBO COTTON - NARROW BAND WITH 60" SNAP-N-GO METAL HANDLE



| | | | | | | |
|--------------|---|-----|-----|-----|----|----------|
| HW-PC-80016 | ProMop Combo – 16 oz / 450 g SynRay Mop – Narrow Band with STEP-N-GO metal 60" Handle / Ensemble ProMop, vadrouille Synray de 16 oz / 450 g, bande étroite, munie d'un manche métallique de 60 po / 152 cm | | | | 12 | \$ 31.31 |
| HW-PC-80020 | ProMop Combo – 20 oz / 550 g SynRay Mop – Narrow Band with STEP-N-GO metal 60" Handle / Ensemble ProMop, vadrouille Synray de 20 oz / 550 g, bande étroite, munie d'un manche métallique de 60 po / 152 cm | 1.6 | .72 | 3.5 | 12 | \$ 31.58 |
| HW-PC-80024 | ProMop Combo – 24 oz / 650 g SynRay Mop – Narrow Band with STEP-N-GO metal 60" Handle / Ensemble ProMop, vadrouille Synray de 24 oz 650 g, bande étroite, munie d'un manche métallique de 60 po / 152 cm | 1.6 | .72 | 3.5 | 12 | \$ 34.39 |
| HW-PC-90020 | Promop Combo – Medium Swinger Mop – Looped – Narrow Band with STEP-N-GO metal 60" Handle / Ensemble ProMop, vadrouille à franges bouclées Swinger, bande étroite, munie d'un manche métallique de STEP-N-GO 60 po / 152cm | 1.6 | .72 | 3.5 | 12 | \$ 37.89 |
| HW-PC-80016C | ProMop Combo – 16 oz / 450 g Cotton Mop – Narrow Band with STEP-N-GO metal 60" Handle / Ensemble ProMop, vadrouille Coton de 16 oz / 450 g, bande étroite, munie d'un manche métallique de 60 po / 152 cm | | | | 12 | \$ 29.69 |
| HW-PC-80020C | ProMop Combo – 20 oz / 550 g Cotton Mop – Narrow Band with STEP-N-GO metal 60" Handle / Ensemble ProMop, vadrouille Coton de 20 oz / 550 g, bande étroite, munie d'un manche métallique de 60 po / 152 cm | 1.6 | .72 | 3.5 | 12 | \$ 31.01 |
| HW-PC-80024C | ProMop Combo – 24 oz / 650 g Cotton Mop – Narrow Band with STEP-N-GO metal 60" Handle / Ensemble ProMop, vadrouille Coton de 24 oz 650 g, bande étroite, munie d'un manche métallique de 60 po / 152 cm | 1.6 | .72 | 3.5 | 12 | \$ 33.42 |

WET MOP ACCESSORIES



| | | | | | | |
|--------------|---|--|--|--|--------|----------|
| EFM-PS-10121 | Laundry Net , White / Filet à buanderie, blanc | | | | 1 | \$ 25.44 |
| SC-7490 | Scrubby Foot Pad -Scuff and Shoe Mark Remover -Fits on Mop Handle - Blue / Tampon à pied pour récurer les éraflures et les marques de soulier - s'adapte au manche de vadrouille - bleu | | | | 10/Bag | \$ 13.67 |



DETACHABLE MOPS / VADROUILLES DÉTACHABLES

BLUE & WHITE STRIP MOP / VADROUILLE EN BANDES BLEUE ET BLANCHE



| MICROFIBER STRIP MOP - LOOPED / FRANGES BOUCLÉES | | | | | | | | | | |
|--|---|---|---|---|---|---|---|---|---|----|
| | 1 | 2 | 3 | 4 | 5 | 6 | 7 | 8 | 9 | 10 |
| Durability / Durabilité | | | | | | | | | | |
| Absorbency / Absorption | | | | | | | | | | |
| Release / Capacité D'Évacuation | | | | | | | | | | |
| Launderability / Blanchiment | | | | | | | | | | |
| Performance / Performance | | | | | | | | | | |

| M2 Code Code M2 | Description | Pack Wt LB (S) Poids (lb) (S) | Pack Wt KG Poids (kg) | Cubic Ft Pi3 | Pack Contenu | List Price Liste des prix |
|--------------------|---|----------------------------------|--------------------------|-----------------|-----------------|------------------------------|
| YM-YST-050253-M48 | Detachable Blue and White Strip Mop with 48" / 122 cm Metal Handle - 20" x 10" / 50 x 25 cm Vadrouille à bandes détachées bleues et blanches avec un manche en métal 48"/122cm - 20" x 10"/50 x 25cm | | | | 12 | \$ 9.91 |
| YM-YST-05025 | Detachable Blue and White Strip Mop - Refill - 20" x 10" / 50 x 25 cm / Rechange de vadrouille à bandes détachées bleues et blanches 20" x 10"/50 x 25 cm | | | | 50/10 | \$ 5.56 |

ECO STRIP MOP / VADROUILLE EN BANDES BLEUE ET BLANCHE



| ECO STRIP - CUT END / BRINS COUPÉS | | | | | | | | | | |
|------------------------------------|---|---|---|---|---|---|---|---|---|----|
| | 1 | 2 | 3 | 4 | 5 | 6 | 7 | 8 | 9 | 10 |
| Durability / Durabilité | | | | | | | | | | |
| Absorbency / Absorption | | | | | | | | | | |
| Release / Capacité D'Évacuation | | | | | | | | | | |
| Launderability / Blanchiment | | | | | | | | | | |
| Performance / Performance | | | | | | | | | | |

| M2 Code Code M2 | Description | Pack Wt LB (S) Poids (lb) (S) | Pack Wt KG Poids (kg) | Cubic Ft Pi3 | Pack Contenu | List Price Liste des prix |
|--------------------|---|----------------------------------|--------------------------|-----------------|-----------------|------------------------------|
| YM-YEC-11140-M48 | Detachable Eco Strip Mop with 48" / 122 cm Metal Handle - Lint Free - 140 g / Vadrouille détachable Eco avec manche de métal 48"/122cm - sans peluche 140g | | | | 10 | \$ 8.59 |
| YM-YEC-11140 | Detachable Eco Strip Mop Refill - Lint Free - 140 g / Rechange de vadrouille détachable Eco - sans peluche 140g | | | | 24 | \$ 3.95 |

MICROFIBER MOP / VADROUILLE EN MICROFIBRE



| MICROFIBER- LOOPED / FRANGES BOUCLÉES | | | | | | | | | | |
|---------------------------------------|---|---|---|---|---|---|---|---|---|----|
| | 1 | 2 | 3 | 4 | 5 | 6 | 7 | 8 | 9 | 10 |
| Durability / Durabilité | | | | | | | | | | |
| Absorbency / Absorption | | | | | | | | | | |
| Release / Capacité D'Évacuation | | | | | | | | | | |
| Launderability / Blanchiment | | | | | | | | | | |
| Performance / Performance | | | | | | | | | | |

ROLLER SPONGE MOP / VADROUILLE ÉPONGE RONDE



| M2 Code Code M2 | Description | Pack Wt LB (S) Poids (lb) (S) | Pack Wt KG Poids (kg) | Cubic Ft Pi3 | Pack Contenu | List Price Liste des prix |
|---|--|----------------------------------|--------------------------|-----------------|-----------------|------------------------------|
| YM-YMF-12200-M48 | Detachable Microfiber Mop with 48" / 122 cm Metal Handle - 200 g / Vadrouille détachable en microfibre avec un manche de métal 48"/122cm - 200g | | | | 12 | \$ 12.22 |
| YM-YMF-12200 | Detachable Microfiber Mop - Refill - 160 g / Rechange de vadrouille détachable - 160 g | | | | 48 | \$ 8.36 |
| ROLLER SPONGE MOP / VADROUILLE ÉPONGE RONDE | | | | | | |
| SM-R1025 | 10" / 25cm Roller Sponge mop / Vadrouille éponge ronde 10"/25cm | | | | | \$ 56.58 |
| SM-R1025R | 10" / 25cm Roller Sponge mop Refill / Rechange de vadrouille éponge ronde 10"/25cm | | | | | \$ 23.56 |

DETATCHABLE YACHT MOPS

VADROUILLES "YACHT" DÉTACHABLES

- Loopy yacht mop is made with a strong durable connector with a universal handle socket
- Loopy is also available in a long lasting Rayon synthic yarn that will withstand repeated laundering and is economical

- La vadrouille bouclée "yacht" est fait d'un connecteur durable avec une douille de manche universelle.
- La vadrouille bouclée est aussi disponible dans un fil de rayonne synthétique durable qui résiste aux lavages répétés et est économique.



- * Handles Sold Separately
- * Refer to page
- * Le manche est vendu séparément
- * Se reporter à la page



Can be made in colours.
Ask your representative
Peut être fait en couleurs
Demandez à votre représentant

| M2 Code Code M2 | Description | Pack Wt LB (S) Poids (lb) (S) | Pack Wt KG Poids (kg) | Cubic Ft Pi3 | Pack Contenu | List Price Liste des prix |
|---|---|----------------------------------|--------------------------|-----------------|-----------------|------------------------------|
| LOOPY DETATCHABLE YACHT MOP / VADROUILLE "YACHT" BOUCLÉE DÉTACHABLE | | | | | | |
| YM-Y200 | 10 Oz./ 275 g Loopy Detachable Yacht Mop - Blue / 10 Oz./ 275 g Vadrouille "Yacht" bouclée détachable - bleu | 7 | 3.5 | | 12 | \$ 12.13 |
| YM-Y212 | 12 Oz./ 350 g Loopy Detachable Yacht Mop - Blue / 12 Oz./ 350 g Vadrouille "Yacht" bouclée détachable - bleu | 10 | 4.5 | | 12 | \$ 15.86 |
| SYNRAY CUT END LOOPY DETATCHABLE YACHT MOP / VADROUILLE "YACHT" DÉTACHABLE 10OZ/275G SYNRAY BOUT COUPÉ | | | | | | |
| YM-Y310 | 10 Oz./ 275 g Detachable Yacht Mop - SYNRAY Cut End / Vadrouille "Yacht" détachable 10oz/275g Synray bout coupé | 8 | 3.5 | | 12 | \$ 11.47 |
| YM-Y312 | 12 Oz. / 350 g Detachable Yacht Mop - SYNRAY Cut End / Vadrouille "Yacht" détachable 12oz/350g Synray bout coupé | 10 | 4.5 | | 12 | \$ 12.48 |
| YM-Y310-M348 | 10 / 275 g Detachable Yacht Mop - SYNRAY Cut End with 48" metal handle / Vadrouille "Yacht" détachable 10 / 275 g Synray bout coupé en manche de métal 48" | | | | 12 | \$ 17.68 |
| COTTON CUT END LOOPY DETATCHABLE YACHT MO / VADROUILLE "YACHT" DÉTACHABLE 8 / 200 G COTTON BOUT COUPÉ | | | | | | |
| YM-Y108C | 8 / 200 g Detachable Yacht Mop - COTTON Cut End / Vadrouille "Yacht" détachable 8 / 200 g Cotton bout coupé | 8 | 3.5 | | 50/10 | \$ 10.72 |
| YM-Y110C | 10 / 250 g Detachable Yacht Mop - COTTON Cut End / Vadrouille "Yacht" détachable 10 /250 g Cotton bout coupé | 10 | 4.5 | | 40/10 | \$ 11.02 |
| YM-Y112C | 12 / 300 g Detachable Yacht Mop - COTTON Cut End / Vadrouille "Yacht" détachable 12 / 300 g Cotton bout coupé | | | | 12 | \$ 12.62 |
| YM-Y116C | 16 / 400 g Detachable Yacht Mop - COTTON Cut End / Vadrouille "Yacht" détachable 16 / 400 g Cotton bout coupé | | | | 12 | \$ 15.47 |
| YM-Y108C-M348M | 8 / 225 g Detachable Yacht Mop - COTTON Cut End with 48" metal handle / Vadrouille "Yacht" détachable 8 / 225 g Cotton bout coupé. manche de métal 48" | | | | 12 | \$ 11.69 |
| YM-Y110C-M348M | 10 / 275 g Detachable Yacht Mop - COTTON Cut End with 48" metal handle / Vadrouille "Yacht" détachable 10 / 275 g Cotton bout coupé. manche de métal 48" | | | | 12 | \$ 11.99 |
| YM-Y112C-M348M | 12 / 350 g Detachable Yacht Mop - COTTON Cut End with 48" metal handle / Vadrouille "Yacht" détachable 12 / 350 g Cotton bout coupé. manche de métal 48" | | | | 12 | \$ 14.72 |
| YM-Y116C-M348M | 16 / 450 g Detachable Yacht Mop - COTTON Cut End with 48" metal handle / Vadrouille "Yacht" détachable 16 / 450 g Cotton bout coupé. manche de métal 48" | | | | 12 | \$ 16.52 |



DETATCHABLE YACHT MOPS / VADROUILLES «YACHT» DÉTACHABLES

Strong durable Deck/Yacht mops are made with a premium cotton yarn or synray yarn and wire bound to a wooden handle

Robustes, durables, les vadrouilles « yacht » sont fabriquées en fil de coton ou de synray de première qualité et attachées avec un fil métallique à un manche en bois.



All yacht mops
are individually bagged

Toutes les vadrouilles
« yacht » sont ensachées
individuellement.



| M2 Code Code M2 | Description | Pack Wt LB (S) Poids (lb) (S) | Pack Wt KG Poids (kg) | Cubic Ft Pi3 | Pack Contenu | List Price Liste des prix |
|---|--|----------------------------------|--------------------------|-----------------|-----------------|------------------------------|
| COTTON YACHT MOPS / VADROUILLE YACHT EN COTTON | | | | | | |
| YM8 | Cotton Yacht Mop with 48" Wooden Handle – 8 oz / 225 g / Vadrouille « yacht » en coton, 8 oz / 225 g, manche en bois de 48" | 14 | 6.5 | 2 | 12 | \$ 7.67 |
| YM10 | Cotton Yacht Mop with 48" Wooden Handle – 10 oz / 275 g / Vadrouille « yacht » en coton, 10 oz / 275 g, manche en bois de 48" | 17 | 7.7 | 2 | 12 | \$ 9.02 |
| YM12 | Cotton Yacht Mop with 48" Wooden Handle – 12 oz / 350 g / Vadrouille « yacht » en coton, 12 oz / 350 g, manche en bois de 48" | 17 | 7.7 | 2 | 12 | \$ 9.70 |
| YM16 | Cotton Yacht Mop with 48" Wooden Handle – 16 oz / 450 g / Vadrouille « yacht » en coton, 16 oz / 450 g, manche en bois de 48" | 21.5 | 10 | 2.7 | 12 | \$ 11.60 |
| YM-HY8 | Cotton Yacht Mop with 54" Wooden Handle – 8 oz / 225 g / Vadrouille « yacht » en coton, 8 oz / 225 g, manche en bois de 54" | 14 | 6.5 | 2 | 12 | \$ 12.42 |
| YM-HY10 | Cotton Yacht Mop with 54" Wooden Handle – 10 oz / 275 g / Vadrouille « yacht » en coton, 10 oz / 275 g, manche en bois de 54" | 17 | 7.7 | 2 | 12 | \$ 12.64 |
| YM-HY12 | Cotton Yacht Mop with 54" Wooden Handle – 12 oz / 350 g / Vadrouille « yacht » en coton, 12 oz / 350 g, manche en bois de 54" | 17 | 7.7 | 2 | 12 | \$ 13.59 |
| YM-HY16 | Cotton Yacht Mop with 54" Wooden Handle – 16 oz / 450 g / Vadrouille « yacht » en coton, 16 oz / 450 g, manche en bois de 54" | 21.5 | 10 | 2.7 | 12 | \$ 14.71 |
| YM-HY20 | Cotton Yacht Mop with 54" Wooden Handle – 20 oz / 550 g / Vadrouille « yacht » en coton, 20 oz / 550 g, manche en bois de 54" | | | | 12 | \$ 16.47 |
| SYNRAY YACHT MOPS / FAUBERTS SYNRAY | | | | | | |
| YM-S8 | Synray Yacht Mop with 48" Wooden Handle – 8 oz / 225 g / Vadrouille « yacht » Synray, 8 oz / 225 g, manche en bois de 48" | 17 | 7.7 | 2 | 12 | \$ 9.92 |
| YM-S10 | Synray Yacht Mop with 48" Wooden Handle – 10 oz / 275 g / Vadrouille « yacht » Synray, 10 oz / 275 g, manche en bois de 48" | 17 | 7.7 | 2 | 12 | \$ 11.19 |
| YM-S10-54 | Synray Yacht Mop with 54" Wooden Handle – 10 oz / 275 g / Vadrouille « yacht » Synray, 10 oz / 275 g, manche en bois de 54" | 17 | 7.7 | 2 | 12 | \$ 13.26 |
| YM-S12 | Synray Yacht Mop with 54" Wooden Handle – 12 oz / 350 g / Vadrouille « yacht » Synray, 12 oz / 350 g, manche en bois de 54" | 17 | 7.7 | 2 | 12 | \$ 13.37 |
| YM-S16 | Synray Yacht Mop with 54" Wooden Handle – 16 oz / 450 g / Vadrouille « yacht » Synray, 16 oz / 450 g, manche en bois de 54" | 21.5 | 9.7 | 2.7 | 12 | \$ 15.23 |
| YM-S20 | Synray Yacht Mop with 54" Wooden Handle – 20 oz / 550 g / Vadrouille « yacht » Synray, 20 oz / 550 g, manche en bois de 54" | 21.5 | 9.7 | 2.7 | 12 | \$ 17.38 |

STEP-N-GO

A NEW AND IMPROVED MOP HANDLE

UN NOUVEAU MANCHE DE VADROUILLE AMÉLIORÉ



- Foot pedal allows you to release the mop without touching the mop handle
- The mop hooks allow the user to lift the mop head without touching – easily grasping the soiled mop head and placing into a garbage receptacle or washing machine

- La pédale permet de libérer la vadrouille sans toucher le manche.
- Le crampon permet de soulever la vadrouille sans y toucher et de saisir facilement la tête de la vadrouille sale pour la mettre à la poubelle ou dans la lessiveuse



| M2 Code Code M2 | Description | Pack Wt LB (S) Poids (lb) (S) | Pack Wt KG Poids (kg) | Cubic Ft Pi3 | Pack Contenu | List Price Liste des prix |
|--------------------|---|----------------------------------|--------------------------|-----------------|-----------------|------------------------------|
| HW-7001F | 54" STEP-N-GO Fiberglass Mop Handle – Blue / Manche de vadrouille de fibre de verre STEP-N-GO, 54 po, bleu | 20 | 9.5 | 7.92 | 12 | \$ 25.63 |
| HW-7000F | 60" STEP-N-GO Fiberglass Mop Handle – Blue / Manche de vadrouille de fibre de verre STEP-N-GO, 60 po, bleu | 21 | 9.6 | 7.92 | 12 | \$ 28.39 |
| HW-7000F-FD | 60" STEP-N-GO Fiberglass Mop Handle with Plastic Rivet – Blue / Manche de vadrouille de fibre de verre avec rivet en plastique STEP-N-GO, 60 po, bleu | 21 | 9.6 | 7.92 | 12 | \$ 33.67 |
| HW-7000F-WH | 60" STEP-N-GO Fiberglass Mop Handle – White / Manche de vadrouille de fibre de verre STEP-N-GO, 60 po, blanc | 21 | 9.6 | 7.92 | 12 | \$ 30.53 |
| HW-7000F-GN | 60" STEP-N-GO Fiberglass Mop Handle – Green/ Manche de vadrouille de fibre de verre STEP-N-GO, 60 po, vert | 21 | 9.6 | 7.92 | 12 | \$ 30.53 |
| HW-7000F-RD | 60" STEP-N-GO Fiberglass Mop Handle – Red / Manche de vadrouille de fibre de verre STEP-N-GO, 60 po, rouge | 21 | 9.6 | 7.92 | 12 | \$ 30.53 |
| HW-7000F-YE | 60" STEP-N-GO Fiberglass Mop Handle – Yellow / Manche de vadrouille de fibre de verre STEP-N-GO, 60 po, jaune | 21 | 9.6 | 7.92 | 12 | \$ 30.53 |
| HW-7000F-OR | 60" STEP-N-GO Fiberglass Mop Handle – Orange / Manche de vadrouille de fibre de verre STEP-N-GO, 60 po, orange | 21 | 9.6 | 7.92 | 12 | \$ 30.53 |



STEP-N-GO MOP HANDLE / MANCHE DE VADROUILLE STEP-N-GO

A VARIETY OF MOP HANDLES
ARE AVAILABLE. / DIVERS
MANCHES SONT DISPONIBLES.



| M2 Code Code M2 | Description | Pack Wt LB (S) Poids (lb) (S) | Pack Wt KG Poids (kg) | Cubic Ft Pi3 | Pack Contenu | List Price Liste des prix |
|--------------------|---|----------------------------------|--------------------------|-----------------|-----------------|------------------------------|
| HW-7002W | 54" STEP-N-GO Wooden Mop Handle / Manche de vadrouille en en bois, STEP-N-GO, 54 po | 21 | 9.6 | 2.92 | 12 | \$ 20.75 |
| HW-7003M | 60" STEP-N-GO Metal Mop Handle / Manche de vadrouille en métal, STEP-N-GO, 60 po | 21 | 9.6 | 2.92 | 12 | \$ 17.89 |
| HW-7003A | 60" STEP-N-GO Aluminum Mop Handle / Manche de vadrouille en aluminium, STEP-N-GO, 60 po | 12 | 9.6 | 2.92 | 12 | \$ 31.09 |
| HW-7004A-TEL | 60" STEP-N-GO Aluminum Telescopic Mop Handle / Manche de vadrouille télescopique en aluminium, STEP-N-GO, 60 po | 21 | 9.6 | 2.92 | 12 | \$ 41.16 |

SNAP-2-GO & SIDE CHANGE MOP HANDLES / MANCHE SNAP-2-GO ET DE VADROUILLE À CHANGEMENT DE CÔTÉ

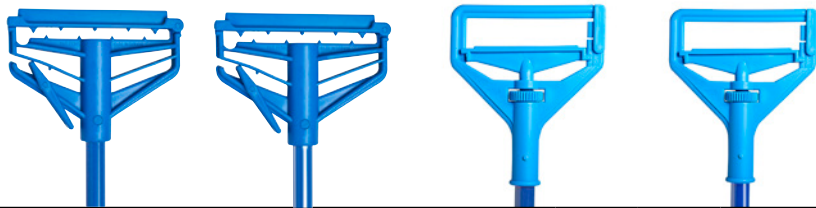

| M2 Code Code M2 | Description | Pack Wt LB (S) Poids (lb) (S) | Pack Wt KG Poids (kg) | Cubic Ft Pi3 | Pack Contenu | List Price Liste des prix |
|--------------------|--|----------------------------------|--------------------------|-----------------|-----------------|------------------------------|
| HW-8054F-BL | 54" SNAP-2-GO Fiberglass Mop Handle - Blue / Manche de vadrouille de fibre de verre SNAP-2-GO, 54 po, bleu | 21 | 9.6 | 7.92 | 12 | \$ 23.43 |
| HW-8060F-BL | 60" SNAP-2-GO Fiberglass Mop Handle - Blue / Manche de vadrouille de fibre de verre SNAP-2-GO, 60 po, bleu | 21 | 9.6 | 7.92 | 12 | \$ 24.61 |
| HW-8160-M | 60" SNAP-2-GO Metal Mop Handle - Blue / Manche de vadrouille en métal SNAP-2-GO, 60 po, bleu | 21 | 9.6 | 7.92 | 12 | \$ 17.10 |
| HW-9054F-BL | 54" Side Change Mop handle FiberGlass Handle - Blue / Manche de vadrouille en fibre de verre 54" - Bleu | | | | 12 | \$ 24.28 |
| HW-9060F-BL | 60" Side Change Mop handle FiberGlass Handle - Blue / Manche de vadrouille en fibre de verre 60" - Bleu | | | | 12 | \$ 25.49 |
| HW-9160-M | 60" Side Change Mop handle Metal Handle - Blue / Manche de vadrouille en métal 60" - Bleu | | | | 12 | \$ 17.75 |

QUICK CHANGE & JAW STYLE AND SCREW TYPE / MANCHES - CHANGEMENT RAPIDE, GENRE MÂCHOIRE OU STYLE VISÉ



Quick Change Style Mop handle can accommodate narrow band and Wide band mops zinc plated to retard corrosion 1 1/8 wood handle.

Le manche de vadrouille à changement rapide s'adapte aux vadrouilles à bande étroite et à bande large. Plaqué zinc pour retarder la corrosion. Manche en bois de 1,1/8 po.

Jaw Style mop handle easy to release mop by unscrewing the collar.

Available in both Fiberglass, metal and wood handle

Manche à mâchoire avec bague de serrement permettant une libération rapide de la vadrouille

Manche de fibre de verre, métal et en bois



PLEASE NOTE:

All our mops are available with our New Screw Top Handle.

Please enquire with your sales representative

S.v.p. notez:

Toutes nos vadrouilles sont disponibles avec notre nouveau manche visé. S.v.p. vous informez auprès de votre représentant.

| M2 Code Code M2 | Description | Pack Wt LB (S) Poids (lb) (S) | Pack Wt KG Poids (kg) | Cubic Ft Pi3 | Pack Contenu | List Price Liste des prix |
|--|--|----------------------------------|--------------------------|-----------------|-----------------|------------------------------|
| QUICK CHANGE/ CHANGEMENT RAPIDE | | | | | | |
| HW-145W | Quick Change - Wood Handle / Changement rapide, Manche en bois | 28 | 13 | 2.92 | 12 | \$ 17.67 |
| HW-145M | Quick Change - Metal Handle / Changement rapide, Manche en metal | 28 | 13 | 2.92 | 12 | \$ 17.63 |
| JAW STYLE / À MÂCHOIRES | | | | | | |
| HW-160A | 60"/152 cm Jaw Style with Aluminum handle - Yellow / À mâchoires avec manche de vadrouille en aluminium-60 po /152 cm, jaune | 17 | 8 | 2.92 | 12 | \$ 23.92 |
| HW-160F | 60"/152 cm Jaw Style with Fiberglass handle - Yellow / À mâchoires avec manche de fibre de verre60 po /152 cm, jaune | 17 | 8 | 2.92 | 12 | \$ 28.26 |
| HW-160M | 60"/152 cm Jaw Style with Black Metal handle - Black / À mâchoires avec manche en métal, 60 po /152 cm - noir | 13 | 6 | 2.92 | 12 | \$ 18.70 |
| HW-160W | Jaw Style with Wood handle / À mâchoires avec manche en bois | 13 | 6 | 2.92 | 12 | \$ 20.51 |
| SCREW TYPE / MANCHE EN BOIS DE STYLE VISÉ | | | | | | |
| HW-1254W | Screw Type Mop 54" Handle - Wood / Manche en bois de style visé 54" | | | | 12 | \$ 24.99 |

STATIC-H

DUSTMOPS / VADROUILLES À ÉPOUSSETER

**Best in Dustmops
Meilleur dans les
vadrouilles à poussière**



**Universal backing /
Support universel**

| STATIC-H - CUT END / BRINS COUPÉS | | | | | | | | | | |
|-------------------------------------|---|---|---|---|---|---|---|---|---|----|
| | 1 | 2 | 3 | 4 | 5 | 6 | 7 | 8 | 9 | 10 |
| Durability / Durabilité | | | | | | | | | | |
| Dust Capture / Capture de poussière | | | | | | | | | | |
| Launderability / Blanchiment | | | | | | | | | | |
| Performance / Performance | | | | | | | | | | |



| M2 Code Code M2 | Description | Pack Wt LB (S) Poids (lb) (S) | Pack Wt KG Poids (kg) | Cubic Ft Pi3 | Pack Contenu | List Price Liste des prix |
|--|---|----------------------------------|--------------------------|-----------------|-----------------|------------------------------|
| STATIC-H™ DUSTMOP – KEYHOLE BACKING – BLUE YARN / VADROUILLE À ÉPOUSSETER STATIC-H^{MD}, ENDOS KEYHOLE, BLEU | | | | | | |
| DM-STH512-BL | STATIC-H – Refill – 5 x 12” – 13 x 30 cm / Recharge STATIC-H, 5 x 12 po, 13 x 30 cm | 5.39 | 2.65 | 1.5 | 12/1 | \$ 19.03 |
| DM-STH518-BL | STATIC-H – Refill – 5 x 18” – 13 x 46 cm / Recharge STATIC-H, 5 x 18 po, 13 x 46 cm | 9.5 | 4.3 | 1.5 | 12/1 | \$ 22.80 |
| DM-STH524-BL | STATIC-H – Refill – 5 x 24” – 13 x 61 cm / Recharge STATIC-H, 5 x 24 po, 13 x 61 cm | 10.5 | 4.8 | 1.5 | 12/1 | \$ 29.64 |
| DM-STH536-BL | STATIC-H – Refill – 5 x 36” – 13 x 91 cm / Recharge STATIC-H, 5 x 36 po, 13 x 91 cm | 15.5 | 7 | 1.8 | 12/1 | \$ 44.02 |
| DM-STH548-BL | STATIC-H – Refill – 5 x 48” – 13 x 122 cm / Recharge STATIC-H, 5 x 48 po, 13 x 122 cm | 21 | 9.5 | 1.8 | 6/1 | \$ 56.81 |
| DM-STH560-BL | STATIC-H – Refill – 5 x 60” – 13 x 152 cm / Recharge STATIC-H, 5 x 60 po, 13 x 152 cm | 25 | 11.3 | 1.8 | 6/1 | \$ 67.48 |
| DM-STH572-BL | STATIC-H – Refill – 5 x 72” – 13 x 182 cm / Recharge STATIC-H, 5 x 72 po, 13 x 182 cm | | | | 2/1 | \$ 93.79 |
| STATIC-H™ DUSTMOP – KEYHOLE BACKING – RED YARN / VADROUILLE À ÉPOUSSETER STATIC-H^{MD}, ENDOS KEYHOLE, ROUGE | | | | | | |
| DM-STH518-RD | STATIC-H – Refill – 5 x 18” – 13 x 46 cm / Recharge STATIC-H, 5 x 18 po, 13 x 46 cm | 9.5 | 4.3 | 1.5 | 12/1 | \$ 22.80 |
| DM-STH524-RD | STATIC-H – Refill – 5 x 24” – 13 x 61 cm / Recharge STATIC-H, 5 x 24 po, 13 x 61 cm | 10.5 | 4.8 | 1.5 | 12/1 | \$ 29.64 |
| DM-STH536-RD | STATIC-H – Refill – 5 x 36” – 13 x 91 cm / Recharge STATIC-H, 5 x 36 po, 13 x 91 cm | 15.5 | 7 | 1.8 | 12/1 | \$ 44.02 |
| DM-STH548-RD | STATIC-H – Refill – 5 x 48” – 13 x 122 cm / Recharge STATIC-H, 5 x 48 po, 13 x 122 cm | 21 | 9.5 | 1.8 | 6/1 | \$ 56.81 |
| STATIC-H™ DUSTMOP – KEYHOLE BACKING – GREEN YARN / VADROUILLE À ÉPOUSSETER STATIC-H^{MD}, ENDOS KEYHOLE, VERT | | | | | | |
| DM-STH518-GN | STATIC-H – Tie-on Refill – 5 x 18” – 13 x 46 cm / Recharge à œillet STATIC-H, 5 x 18 po, 13 x 46 cm | 9.5 | 4.3 | 1.5 | 12/1 | \$ 22.80 |
| DM-STH524-GN | STATIC-H – Tie-on Refill – 5 x 24” – 13 x 61 cm / Recharge à œillet STATIC-H, 5 x 24 po, 13 x 61 cm | 10.5 | 4.8 | 1.5 | 12/1 | \$ 29.64 |
| DM-STH536-GN | STATIC-H – Tie-on Refill – 5 x 36” – 13 x 91 cm / Recharge à œillet STATIC-H, 5 x 36 po, 13 x 91 cm | 15.5 | 7 | 1.8 | 12/1 | \$ 44.02 |
| DM-STH548-GN | STATIC-H – Tie-on Refill – 5 x 48” – 13 x 122 cm / Recharge à œillet STATIC-H, 5 x 48 po, 13 x 122 cm | 21 | 9.5 | 1.8 | 6/1 | \$ 56.81 |
| STATIC-H™ DUSTMOP – BREAKAWAY BACKING – BLUE / VADROUILLE À ÉPOUSSETER STATIC-H^{MD}, ENDOS BREAKAWAY, BLEU | | | | | | |
| DMBA-STH518-BL | STATIC-H – BreakAway – 5 x 18” – 13 x 46 cm / Vadrouille à épousseter STATIC-H, 5 x 18 po, 13 x 46 cm | 9.5 | 4.3 | 1.5 | 12/1 | \$ 22.80 |
| DMBA-STH524-BL | STATIC-H – BreakAway – 5 x 24” – 13 x 61 cm / Vadrouille à épousseter STATIC-H, 5 x 24 po, 13 x 61 cm | 10.5 | 4.8 | 1.5 | 12/1 | \$ 29.64 |
| DMBA-STH536-BL | STATIC-H – BreakAway – 5 x 36” – 13 x 91 cm / Vadrouille à épousseter STATIC-H, 5 x 36 po, 13 x 91 cm | 15.5 | 7 | 1.8 | 12/1 | \$ 44.02 |
| DMBA-STH548-BL | STATIC-H – BreakAway – 5 x 48” – 13 x 122 cm / Vadrouille à épousseter STATIC-H, 5 x 48 po, 13 x 122 cm | 21 | 9.5 | 1.8 | 6/1 | \$ 56.81 |



M-TECH MICROFIBER DUSTMOP STYLE - TIE-ON STYLE BACKING VADROUILLE À ÉPOUSSETER M-TECH - ENDOS TIE-ON

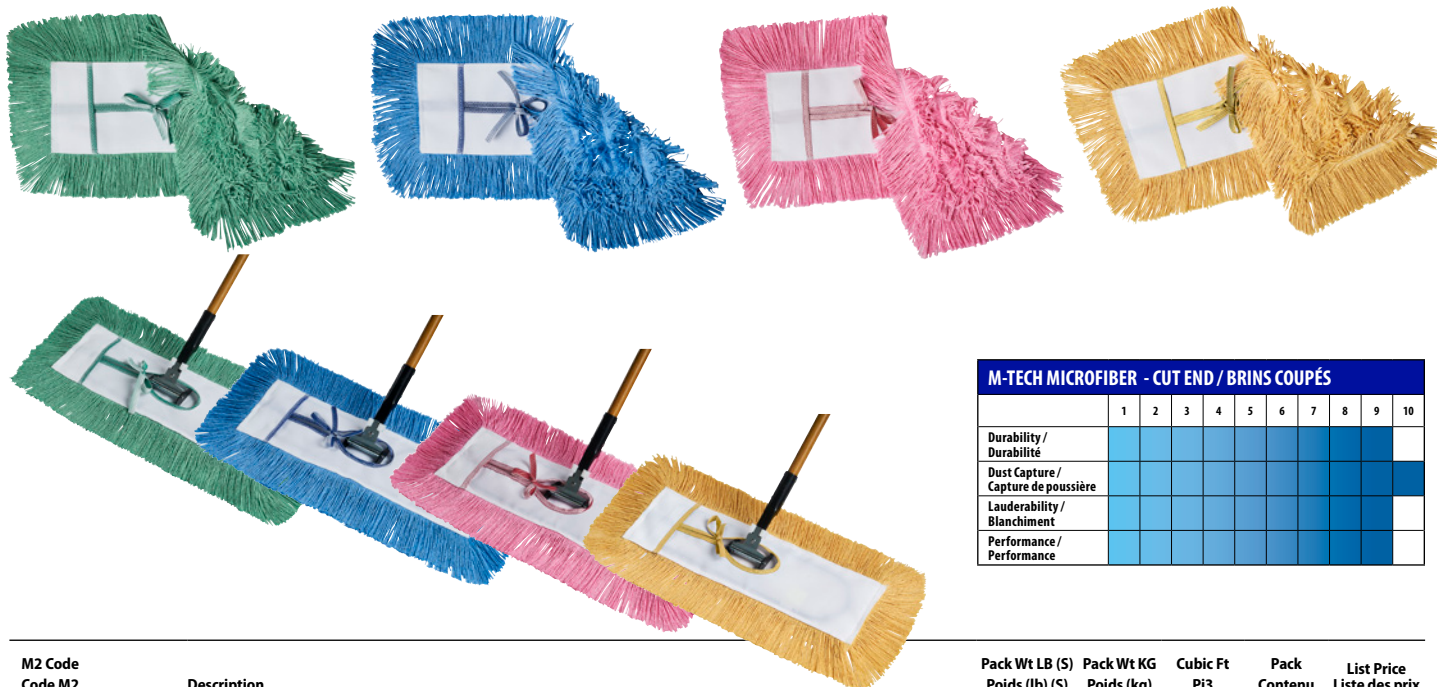

| M-TECH MICROFIBER - CUT END / BRINS COUPÉS | | | | | | | | | | |
|--|---|---|---|---|---|---|---|---|---|----|
| | 1 | 2 | 3 | 4 | 5 | 6 | 7 | 8 | 9 | 10 |
| Durability / Durabilité | | | | | | | | | | |
| Dust Capture / Capture de poussière | | | | | | | | | | |
| Launderability / Blanchiment | | | | | | | | | | |
| Performance / Performance | | | | | | | | | | |

| M2 Code Code M2 | Description | Pack Wt LB (S) Poids (lb) (S) | Pack Wt KG Poids (kg) | Cubic Ft Pi3 | Pack Contenu | List Price Liste des prix |
|--|---|----------------------------------|--------------------------|-----------------|-----------------|------------------------------|
| M-TECH™ DUSTMOP – KEYHOLE BACKING – GREEN YARN / VADROUILLE À ÉPOUSSETER M-TECH™, ENDOS KEYHOLE, VERT | | | | | | |
| DM-MT518-GN | M-TECH – Refill – 5 x 18” – 13 x 46 cm / Recharge M-TECH, 5 x 18 po, 13 x 46 cm | 9.5 | 4.3 | 1.5 | 12/1 | \$ 22.67 |
| DM-MT524-GN | M-TECH – Refill – 5 x 24” – 13 x 61 cm / Recharge M-TECH, 5 x 24 po, 13 x 61 cm | 10.5 | 4.8 | 1.5 | 12/1 | \$ 27.26 |
| DM-MT536-GN | M-TECH – Refill – 5 x 36” – 13 x 91 cm / Recharge M-TECH, 5 x 36 po, 13 x 91 cm | 15.5 | 7 | 1.8 | 12/1 | \$ 40.48 |
| DM-MT548-GN | M-TECH – Refill – 5 x 48” – 13 x 122 cm / Recharge M-TECH, 5 x 48 po, 13 x 122 cm | 21 | 9.5 | 1.8 | 6/1 | \$ 51.75 |
| DM-MT560-GN | M-TECH – Refill – 5 x 60” – 13 x 152 cm / Recharge M-TECH, 5 x 60 po, 13 x 152 cm | 25 | 11.3 | 1.8 | 6/1 | \$ 62.07 |
| DM-MT572-GN | M-TECH – Refill – 5 x 72” – 13 x 182 cm / Recharge M-TECH, 5 x 72 po, 13 x 182 cm | | | | 2/1 | \$ 74.80 |
| M-TECH™ DUSTMOP – KEYHOLE BACKING – BLUE YARN / VADROUILLE À ÉPOUSSETER M-TECH™, ENDOS KEYHOLE, BLEU | | | | | | |
| DM-MT518-BL | M-TECH – Refill – 5 x 18” – 13 x 46 cm / Recharge M-TECH, 5 x 18 po, 13 x 46 cm | 9.5 | 4.3 | 1.5 | 12/1 | \$ 22.67 |
| DM-MT524-BL | M-TECH – Refill – 5 x 24” – 13 x 61 cm / Recharge M-TECH, 5 x 24 po, 13 x 61 cm | 10.5 | 4.8 | 1.5 | 12/1 | \$ 27.26 |
| DM-MT536-BL | M-TECH – Refill – 5 x 36” – 13 x 91 cm / Recharge M-TECH, 5 x 36 po, 13 x 91 cm | 15.5 | 7 | 1.8 | 12/1 | \$ 40.48 |
| DM-MT548-BL | M-TECH – Refill – 5 x 48” – 13 x 122 cm / Recharge M-TECH, 5 x 48 po, 13 x 122 cm | 21 | 9.5 | 1.8 | 6/1 | \$ 51.75 |
| DM-MT560-BL | M-TECH – Refill – 5 x 60” – 13 x 152 cm / Recharge M-TECH, 5 x 60 po, 13 x 152 cm | 25 | 11.3 | 1.8 | 6/1 | \$ 62.07 |
| DM-MT572-BL | M-TECH – Refill – 5 x 72” – 13 x 182 cm / Recharge M-TECH, 5 x 72 po, 13 x 182 cm | | | | 2/1 | \$ 74.80 |
| M-TECH™ DUSTMOP – KEYHOLE BACKING – RED YARN / VADROUILLE À ÉPOUSSETER M-TECH™, ENDOS KEYHOLE, ROUGE | | | | | | |
| DM-MT518-RD | M-TECH – Refill – 5 x 18” – 13 x 46 cm / Recharge M-TECH, 5 x 18 po, 13 x 46 cm | 9.5 | 4.3 | 1.5 | 12/1 | \$ 22.67 |
| DM-MT524-RD | M-TECH – Refill – 5 x 24” – 13 x 61 cm / Recharge M-TECH, 5 x 24 po, 13 x 61 cm | 10.5 | 4.8 | 1.5 | 12/1 | \$ 27.26 |
| DM-MT536-RD | M-TECH – Refill – 5 x 36” – 13 x 91 cm / Recharge M-TECH, 5 x 36 po, 13 x 91 cm | 15.5 | 7 | 1.8 | 12/1 | \$ 40.48 |
| DM-MT548-RD | M-TECH – Refill – 5 x 48” – 13 x 122 cm / Recharge M-TECH, 5 x 48 po, 13 x 122 cm | 21 | 9.5 | 1.8 | 6/1 | \$ 51.75 |
| DM-MT560-RD | M-TECH – Refill – 5 x 60” – 13 x 152 cm / Recharge M-TECH, 5 x 60 po, 13 x 152 cm | 25 | 11.3 | 1.8 | 6/1 | \$ 62.07 |
| DM-MT572-RD | M-TECH – Refill – 5 x 72” – 13 x 182 cm / Recharge M-TECH, 5 x 72 po, 13 x 182 cm | | | | 2/1 | \$ 74.80 |
| M-TECH™ DUSTMOP – KEYHOLE BACKING – YELLOW YARN / VADROUILLE À ÉPOUSSETER M-TECH™, ENDOS KEYHOLE, JAUNE | | | | | | |
| DM-MT518-YE | M-TECH – Refill – 5 x 18” – 13 x 46 cm / Recharge M-TECH, 5 x 18 po, 13 x 46 cm | 9.5 | 4.3 | 1.5 | 12/1 | \$ 22.67 |
| DM-MT524-YE | M-TECH – Refill – 5 x 24” – 13 x 61 cm / Recharge M-TECH, 5 x 24 po, 13 x 61 cm | 10.5 | 4.8 | 1.5 | 12/1 | \$ 27.26 |
| DM-MT536-YE | M-TECH – Refill – 5 x 36” – 13 x 91 cm / Recharge M-TECH, 5 x 36 po, 13 x 91 cm | 15.5 | 7 | 1.8 | 12/1 | \$ 40.48 |
| DM-MT548-YE | M-TECH – Refill – 5 x 48” – 13 x 122 cm / Recharge M-TECH, 5 x 48 po, 13 x 122 cm | 21 | 9.5 | 1.8 | 6/1 | \$ 51.75 |
| DM-MT560-YE | M-TECH – Refill – 5 x 60” – 13 x 152 cm / Recharge M-TECH, 5 x 60 po, 13 x 152 cm | 25 | 11.3 | 1.8 | 6/1 | \$ 62.07 |
| DM-MT572-YE | M-TECH – Refill – 5 x 72” – 13 x 182 cm / Recharge M-TECH, 5 x 72 po, 13 x 182 cm | | | | 2/1 | \$ 74.80 |

MICRO-PET

MICROFIBER DUSTMOPS

VADROUILLES À ÉPOUSSETER EN MICROFIBRE MICRO PET

| MICRO-PET - CUT END / BRINS COUPÉS | | | | | | | | | | |
|-------------------------------------|---|---|---|---|---|---|---|---|---|----|
| | 1 | 2 | 3 | 4 | 5 | 6 | 7 | 8 | 9 | 10 |
| Durability / Durabilité | | | | | | | | | | |
| Dust Capture / Capture de poussière | | | | | | | | | | |
| Launderability / Blanchiment | | | | | | | | | | |
| Performance / Performance | | | | | | | | | | |



MICRO-PET MICROFIBER DUSTMOP / VADROUILLE À ÉPOUSSETER EN MICROFIBRE "MICRO-PET"

- Launderable
- No treatment required
- Long lasting



| M2 Code Code M2 | Description | Pack Wt LB (S) Poids (lb) (S) | Pack Wt KG Poids (kg) | Cubic Ft Pi3 | Pack Contenu | List Price Liste des prix |
|--------------------|---|----------------------------------|--------------------------|-----------------|-----------------|------------------------------|
| DM-MPE518 | Micro-Pet Microfiber Dustmop – 5 x 18"– 46 x 13cm / Vadrouille à épousseter en microfibre Micro-Pet, 5 x 18 po, 46 x 13cm | 9.5 | 4.3 | 1.5 | 12/1 | \$ 22.67 |
| DM-MPE524 | Micro-Pet Microfiber Dustmop – 5 x 24"– 61 x 13cm / Vadrouille à épousseter en microfibre Micro-Pet, 5 x 24 po, 61 x 13cm | 10.5 | 4.8 | 1.5 | 12/1 | \$ 27.26 |
| DM-MPE536 | Micro-Pet Microfiber Dustmop – 5 x 36"– 91 x 13cm / Vadrouille à épousseter en microfibre Micro-Pet, 5 x 36 po, 91 x 13cm | 15.5 | 7 | 1.8 | 12/1 | \$ 40.49 |
| DM-MPE548 | Micro-Pet Microfiber Dustmop – 5 x 48"– 122 x 13cm / Vadrouille à épousseter en microfibre Micro-Pet, 5 x 48 po, 122 x 13cm | 21 | 9.5 | 1.8 | 6/1 | \$ 51.75 |
| DM-MPE560 | Micro-Pet Microfiber Dustmop – 5 x 60"– 152 x 13cm / Vadrouille à épousseter en microfibre Micro-Pet, 5 x 60 po, 152 x 13cm | 25 | 11.3 | 1.8 | 6/1 | \$ 62.06 |
| DM-MPE572 | Micro-Pet Microfiber Dustmop – 5 x 72"– 182 x 13cm / Vadrouille à épousseter en microfibre Micro-Pet, 5 x 72 po, 182 x 13cm | 4.6 | 2.1 | 1.25 | 2/1 | \$ 74.80 |



M-TECH MICROFIBER DUSTMOP / VADROUILLE À ÉPOUSSETER EN MICROFIBRE M-TECH

- M-Tech Dustmop can be used wet or dry
- Next generation microfiber technology
- No chemicals or disinfectants needed – cleans better than all other microfiber mops
- Cleans and removes bacteria

| M-TECH MICROFIBER - CUT END / BRINS COUPÉS | | | | | | | | | | |
|--|---|---|---|---|---|---|---|---|---|----|
| | 1 | 2 | 3 | 4 | 5 | 6 | 7 | 8 | 9 | 10 |
| Durability / Durabilité | | | | | | | | | | |
| Dust Capture / Capture de poussière | | | | | | | | | | |
| Launderability / Blanchiment | | | | | | | | | | |
| Performance / Performance | | | | | | | | | | |

- La vadrouille à épousseter M-tech s'utilise mouillée ou sèche.
- Technologie microfibre de nouvelle génération
- Aucuns produits chimiques ou désinfectants ne sont nécessaires; nettoie mieux que toutes les autres vadrouilles en microfibre.
- Nettoie et élimine les bactéries.

| M2 Code Code M2 | Description | Pack Wt LB (S) Poids (lb) (S) | Pack Wt KG Poids (kg) | Cubic Ft Pi3 | Pack Contenu | List Price Liste des prix |
|--------------------|---|----------------------------------|--------------------------|-----------------|-----------------|------------------------------|
| DM-T518 | M-Tech Microfiber Dustmop - Tie-on – 5 x 18"– 46 x 13cm / Vadrouille à épousseter en microfibre M-Tech - Attacher, 5 x 18 po, 46 x 13cm | 9.5 | 4.3 | 1.5 | 12/1 | \$ 26.67 |
| DM-T524 | M-Tech Microfiber Dustmop - Tie-on – 5 x 24"– 61 x 13cm / Vadrouille à épousseter en microfibre M-Tech - Attacher, 5 x 24 po, 61 x 13cm | 10.5 | 4.8 | 1.5 | 12/1 | \$ 33.15 |
| DM-T536 | M-Tech Microfiber Dustmop - Tie-on – 5 x 36"– 91 x 13cm / Vadrouille à épousseter en microfibre M-Tech - Attacher, 5 x 36 po, 91 x 13cm | 15.5 | 7 | 1.8 | 12/1 | \$ 48.08 |
| DM-T548 | M-Tech Microfiber Dustmop - Tie-on – 5 x 48"– 122 x 13cm / Vadrouille à épousseter en microfibre M-Tech - Attacher, 5 x 48 po, 122 x 13cm | 21 | 9.5 | 1.8 | 12/1 | \$ 62.02 |



G-STAT

LOOPED END DUSTMOP / VADROUILLES À ÉPOUSSETER EMBOUITS BOUCLÉS

G-STAT - LOOPED / FRANGES BOUCLÉES

| | 1 | 2 | 3 | 4 | 5 | 6 | 7 | 8 | 9 | 10 |
|-------------------------------------|---|---|---|---|---|---|---|---|---|----|
| Durability / Durabilité | | | | | | | | | | |
| Dust Capture / Capture de poussière | | | | | | | | | | |
| Launderability / Blanchiment | | | | | | | | | | |
| Performance / Performance | | | | | | | | | | |



G-Stat dustmops are made with special long wearing yarn to help attract dust and dirt particles. Made with a strong long wearing Polyester backing with reinforced stitching to prolong the life of the dustmop. Available in cut end or looped.

Les vadrouilles à épousseter G-Stat sont faites avec de longs fils spéciaux pour aider à attirer les particules de poussière et de saleté. Fabriqué avec un support en polyester extra-fort avec coutures renforcées pour prolonger la vie de la vadrouille. Disponible en bouts coupés ou bouclés.

| M2 Code Code M2 | Description | Pack Wt LB (S) Poids (lb) (S) | Pack Wt KG Poids (kg) | Cubic Ft Pi3 | Pack Contenu | List Price Liste des prix |
|--|---|----------------------------------|--------------------------|-----------------|-----------------|------------------------------|
| G-STAT LOOPED END DUSTMOP / VADROUILLE À ÉPOUSSETER G-STAT À FRANGES BOUCLÉES | | | | | | |
| DM-GST518-L-BL | G-STAT Dustmop – 5 x 18”– 46 x 13cm / G-STAT - vadrouilles à épousseter embouts bouclés, 5 x 18 po, 46 x 13cm | 8.08 | 3.67 | | 12/1 | \$ 20.96 |
| DM-GST524-L-BL | G-STAT Dustmop – 5 x 24”– 61 x 13cm / G-STAT - vadrouilles à épousseter embouts bouclés, 5 x 24 po, 61 x 13cm | 11.71 | 5.32 | | 12/1 | \$ 24.77 |
| DM-GST536-L-BL | G-STAT Dustmop – 5 x 36”– 91 x 13cm / G-STAT - vadrouilles à épousseter embouts bouclés, 5 x 36 po, 91 x 13cm | 14.76 | 6.71 | | 12/1 | \$ 8.04 |
| DM-GST548-L-BL | G-STAT Dustmop – 5 x 48”– 122 x 13cm / G-STAT - vadrouilles à épousseter embouts bouclés, 5 x 48 po, 122 x 13cm | 21.54 | 9.79 | | 6/1 | \$ 47.33 |

G-STAT CUT END DUSTMOP / VADROUILLE À BRINS COUPÉS G-STAT



| M2 Code Code M2 | Description | Pack Wt LB (S) Poids (lb) (S) | Pack Wt KG Poids (kg) | Cubic Ft Pi3 | Pack Contenu | List Price Liste des prix |
|---|---|----------------------------------|--------------------------|-----------------|-----------------|------------------------------|
| G-STAT CUT END DUSTMOP - KEYHOLE / VADROUILLE À BRINS COUPÉS G-STAT , ENDOS KEYHOLE | | | | | | |
| DM-GST518-BL | G-STAT Dustmop – 5 x 18”– 46 x 13cm / G-STAT - vadrouilles à épousseter embouts bouclés, 5 x 18 po, 46 x 13cm | 9.5 | 4.3 | 1.5 | 12/1 | \$ 19.59 |
| DM-GST524-BL | G-STAT Dustmop – 5 x 24”– 61 x 13cm / G-STAT - vadrouilles à épousseter embouts bouclés v, 5 x 24 po, 61 x 13cm | 10.5 | 4.8 | 1.5 | 12/1 | \$ 23.15 |
| DM-GST536-BL | G-STAT Dustmop – 5 x 36”– 91 x 13cm / G-STAT - vadrouilles à épousseter embouts bouclés, 5 x 36 po, 91 x 13cm | 15.5 | 7 | 1.8 | 12/1 | \$ 35.55 |
| DM-GST548-BL | G-STAT Dustmop – 5 x 48”– 122 x 13cm / G-STAT - vadrouilles à épousseter embouts bouclés, 5 x 48 po, 122 x 13cm | 21 | 9.5 | 1.8 | 6/1 | \$ 44.24 |
| G-STAT CUT END DUSTMOP - BREAKAWAY / VADROUILLE À BRINS COUPÉS G-STAT, ENDOS BREAKAWAY | | | | | | |
| DMBA-GST518L-BL | G-STAT Dustmop – 5 x 18”– 46 x 13cm / G-STAT - vadrouilles à épousseter embouts bouclés, 5 x 18 po, 46 x 13cm | 9.5 | 4.3 | 1.5 | 12/1 | \$ 20.96 |
| DMBA-GST524L-BL | G-STAT Dustmop – 5 x 24”– 61 x 13cm / G-STAT - vadrouilles à épousseter embouts bouclés v, 5 x 24 po, 61 x 13cm | 10.5 | 4.8 | 1.5 | 12/1 | \$ 24.77 |
| DMBA-GST536L-BL | G-STAT Dustmop – 5 x 36”– 91 x 13cm / G-STAT - vadrouilles à épousseter embouts bouclés, 5 x 36 po, 91 x 13cm | 15.5 | 7 | 1.8 | 12/1 | \$ 38.04 |
| DMBA-GST548L-BL | G-STAT Dustmop – 5 x 48”– 122 x 13cm / G-STAT - vadrouilles à épousseter embouts bouclés, 5 x 48 po, 122 x 13cm | 21 | 9.5 | 1.8 | 6/1 | \$ 47.33 |

COTTON DUSTMOPS / VADROUILLE À ÉPOUSSETER EN COTON



3" / 7.6 cm width available upon request /
Largeur 3"/7.6 cm disponible sur demande

M2 Professional style cotton Dustmops are made with one of the highest grades of cotton yarn and are designed for areas where laundering is not possible.

- Ideal for areas embedded with dirt and soil.
- An economical choice

Les vadrouilles à épousseter professionnelles en coton M2 sont fabriquées avec du fil de coton de la plus haute qualité et sont conçues pour les endroits où il n'y a pas de laverie.

- Idéales pour déloger la saleté incrustée
- Un choix économique

COTTON - CUT END / BRINS COUPÉS

| | 1 | 2 | 3 | 4 | 5 | 6 | 7 | 8 | 9 | 10 |
|-------------------------------------|---|---|---|---|---|---|---|---|---|----|
| Durability / Durabilité | | | | | | | | | | |
| Dust Capture / Capture de poussière | | | | | | | | | | |
| Launderability / Blanchiment | | | | | | | | | | |
| Performance / Performance | | | | | | | | | | |

* Launderable but not highly recommended
* Lavable mais pas fortement recommandé

| M2 Code Code M2 | Description | Pack Wt LB (S) Poids (lb) (S) | Pack Wt KG Poids (kg) | Cubic Ft Pi3 | Pack Contenu | List Price Liste des prix |
|------------------------------------|--|----------------------------------|--------------------------|-----------------|-----------------|------------------------------|
| 5" / 13 cm Tie-on Refill | | | | | | |
| DM-C518 | Cotton Dustmop - Tie-on - 5 x 18" - 13 x 46 cm / Vadrouille à épousseter en coton à œillet, 5 x 18 po, 13 x 46 cm | 10 | 4.5 | 1 | 12/1 | \$ 17.15 |
| DM-C524 | Cotton Dustmop - Tie-on - 5 x 24" - 13 x 61cm / Vadrouille à épousseter en coton à œillet, 5 x 24 po, 13 x 61cm | 13 | 6 | 1 | 12/1 | \$ 20.75 |
| DM-C536 | Cotton Dustmop - Tie-on - 5 x 36" - 13 x 91cm / Vadrouille à épousseter en coton à œillet, 5 x 36 po, 13 x 91cm | 18 | 8 | 1 | 12/1 | \$ 36.84 |
| DM-C548 | Cotton Dustmop - Tie-on - 5 x 48" - 13 x 122 cm / Vadrouille à épousseter en coton à œillet, 5 x 48 po, 13 x 122 cm | 21 | 10 | 1 | 6/1 | \$ 40.84 |
| DM-C560 | Cotton Dustmop - Tie-on - 5 x 60" - 13 x 152 cm / Vadrouille à épousseter en coton à œillet, 5 x 60 po, 13 x 152 cm | | | | 6/1 | \$ 55.54 |
| DM-C572 | Cotton Dustmop - Tie-on - 5 x 72" - 13 x 182 cm / Vadrouille à épousseter en coton à œillet, 5 x 72 po, 13 x 182 cm | | | | 2/1 | \$ 62.87 |
| 5" / 13 cm Breakaway Refill | | | | | | |
| DMBA-C518 | Cotton Dustmop - Breakaway - 5 x 18" - 13 x 46 cm / Vadrouille à épousseter en coton à œillet, 5 x 18 po, 13 x 46 cm | 10 | 4.5 | 1 | 12 | \$ 14.55 |
| DMBA-C524 | Cotton Dustmop - Breakaway - 5 x 24" - 13 x 61cm / Vadrouille à épousseter en coton à œillet, 5 x 24 po, 13 x 61cm | 13 | 6 | 1 | 12 | \$ 17.61 |
| DMBA-C536 | Cotton Dustmop - Breakaway - 5 x 36" - 13 x 91cm / Vadrouille à épousseter en coton à œillet, 5 x 36 po, 13 x 91cm | 18 | 8 | 1 | 12 | \$ 27.85 |
| DMBA-C548 | Cotton Dustmop - Breakaway - 5 x 48" - 13 x 122 cm / Vadrouille à épousseter en coton à œillet, 5 x 48 po, 13 x 122 cm | 21 | 10 | 1 | 12 | \$ 34.65 |

PRO TWIST DUST MOP - BLUE



VALUE ECONOMY - CUT END / BRINS COUPÉS

| | 1 | 2 | 3 | 4 | 5 | 6 | 7 | 8 | 9 | 10 |
|-------------------------------------|---|---|---|---|---|---|---|---|---|----|
| Durability / Durabilité | | | | | | | | | | |
| Dust Capture / Capture de poussière | | | | | | | | | | |
| Launderability / Blanchiment | | | | | | | | | | |
| Performance / Performance | | | | | | | | | | |

* Launderable but not highly recommended
* Lavable mais pas fortement recommandé

| M2 Code Code M2 | Description | Pack Wt LB (S) Poids (lb) (S) | Pack Wt KG Poids (kg) | Cubic Ft Pi3 | Pack Contenu | List Price Liste des prix |
|--------------------|--|----------------------------------|--------------------------|-----------------|-----------------|------------------------------|
| DM-VE518-BL | Universal Pro Twist Dustmop - Tie-on- 5 x 18" - 13 x 46 cm / 5 x 18 po, 13 x 46 cm | | | | 12 | \$ 13.62 |
| DM-VE524-BL | Universal Pro Twist Dustmop - Tie-on- 5 x 24" - 13 x 61 cm / 5 x 24 po, 13 x 61 cm | | | | 12 | \$ 16.65 |
| DM-VE536-BL | Universal Pro Twist Dustmop - Tie-on- 5 x 36" - 13 x 91 cm / 5 x 36 po, 13 x 91 cm | | | | 12 | \$ 22.70 |
| DM-VE548-BL | Universal Pro Twist Dustmop - Tie-on- 5 x 48" - 13 x 122 cm / 5 x 48 po, 13 x 122 cm | | | | 12 | \$ 27.09 |

SCRUBBY



| M2 Code Code M2 | Description | Pack Wt LB (S) Poids (lb) (S) | Pack Wt KG Poids (kg) | Cubic Ft Pi3 | Pack Contenu | List Price Liste des prix |
|--------------------|--|----------------------------------|--------------------------|-----------------|-----------------|------------------------------|
| SC-7490 | Scrubby Foot Pad -Scuff and Shoe Mark Remover -Fits on Mop Handle - Blue / Tampon à pied pour récurer les éraflures et les marques de soulier - s'adapte au manche de vadrouille - bleu | | | | 10/Bag | \$ 13.67 |



DISPOSABLE COTTON DUSTMOPS / JETABLE VADROUILLE À ÉPOUSSETER EN COTON

| COTTON - CUT END / BRINS COUPÉS | | | | | | | | | | |
|-------------------------------------|---|---|---|---|---|---|---|---|---|----|
| | 1 | 2 | 3 | 4 | 5 | 6 | 7 | 8 | 9 | 10 |
| Durability / Durabilité | | | | | | | | | | |
| Dust Capture / Capture de poussière | | | | | | | | | | |
| Launderability / Blanchiment | | | | | | | | | | |
| Performance / Performance | | | | | | | | | | |



| M2 Code Code M2 | Description | Pack Wt LB (S) Poids (lb) (S) | Pack Wt KG Poids (kg) | Cubic Ft Pi3 | Pack Contenu | List Price Liste des prix |
|--------------------|---|----------------------------------|--------------------------|-----------------|-----------------|------------------------------|
| DM-DP18 | Disposable Cotton Dustmop – Tie-on – 5 x 18" – 13 x 46 cm / Jetable Vadrouille à épousseter en Coton à œillet, 5 x 18 po, 13 x 46 cm | 10 | 4.5 | 1 | 12 | \$ 14.60 |
| DM-DP24 | Disposable Cotton Dustmop – Tie-on – 5 x 24" – 13 x 61 cm / Jetable Vadrouille à épousseter en Coton à œillet, 5 x 24 po, 13 x 61 cm | 13 | 6 | 1 | 12 | \$ 17.15 |
| DM-DP36 | Disposable Cotton Dustmop – Tie-on – 5 x 36" – 13 x 91 cm / Jetable Vadrouille à épousseter en Coton à œillet, 5 x 36 po, 13 x 91 cm | 18 | 8 | 1 | 12 | \$ 22.92 |
| DM-DP48 | Disposable Cotton Dustmop – Tie-on – 5 x 48" – 13 x 122 cm / Jetable Vadrouille à épousseter en Coton à œillet, 5 x 48 po, 13 x 122 cm | 21 | 10 | 1 | 6/1 | \$ 30.01 |
| DM-DP60 | Disposable Cotton Dustmop – Tie-on – 5 x 60" – 13 x 152 cm / Jetable Vadrouille à épousseter en Coton à œillet, 5 x 60 po, 13 x 152 cm | | | | 6/1 | \$ 36.31 |
| DM-DP72 | Disposable Cotton Dustmop – Tie-on – 5 x 72" – 13 x 182 cm / Jetable Vadrouille à épousseter en Coton à œillet, 5 x 72 po, 13 x 182 cm | | | | 2/1 | \$ 48.07 |



CLIPPER FRAME & HANDLE / CADRE ET MANCHE «CLIPPER»



Collar releases to allow for dustmop head to swivel

Le dispositif de débloccage permet à la tête de la vadrouille à épousseter de pivoter.



Closed 43" / 109cm - Extended 78" / 172 cm

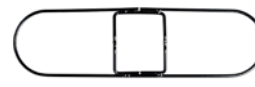

24"

Can fit a variety of handles
S'adapte à divers manches

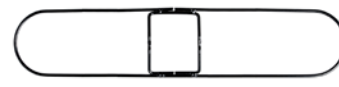

48"

| M2 Code Code M2 | Description | Pack Wt LB (S) Poids (lb) (S) | Pack Wt KG Poids (kg) | Cubic Ft Pi3 | Pack Contenu | List Price Liste des prix |
|--|--|----------------------------------|--------------------------|-----------------|-----------------|------------------------------|
| CLIPPER FRAME / CADRE « CLIPPER » | | | | | | |
| DF-CL518 | Clipper Frame Only – 5 x 18" ^{mm} – 13 x 46 cm / Clipper» seulement, 5 x 18 po / 13 x 46 cm | 19 | 8.5 | | 12/1 | \$ 9.93 |
| DF-CL524 | Clipper Frame Only – 5 x 24" – 13 x 61cm / Clipper» seulement, 5 x 24 po / 13 x 61cm | 20 | 9 | | 12/1 | \$ 11.15 |
| DF-CL536 | Clipper Frame Only – 5 x 36" – 13 x 91cm / Clipper» seulement, 5 x 36 po / 13 x 91cm | 22 | 10 | | 12/1 | \$ 13.27 |
| DF-CL548 | Clipper Frame Only – 5 x 48" – 13 x 122 cm / Clipper» seulement, 5 x 48 po / 13 x 122 cm | 28 | 12.5 | | 12/1 | \$ 23.03 |
| DF-CL560 | Clipper Frame Only – 5 x 60" – 13 x 152 cm / Clipper» seulement, 5 x 60 po / 13 x 152 cm | 28 | 12.5 | | 12/1 | \$ 27.91 |
| DF-CL572 | Clipper Frame Only – 5 x 72" – 13 x 182 cm / Clipper» seulement, 5 x 72 po / 13 x 182 cm | 28.5 | 13 | | 12/1 | \$ 37.72 |



Wood
Handle
Manche
en bois



Metal Handle
Manche en
métal



Aluminum
Handle
Manche en
aluminium



Fibreglass
Handle
Manche de
fibre de verre



Extendable
Handle
Manche
extensible

| CLIPPER HANDLES / MANCHES | | | | | | |
|----------------------------------|---|-----|------|--|------|-----------------|
| DF-CL60 | 60" Clipper Handle – Wood / Manche « Clipper », 60 po, en bois | 7.7 | 17 | | 12/1 | \$ 15.43 |
| DF-CL60-M | 60" Clipper Metal Handle / Manche en métal « Clipper », 60 po | 7 | 5.5 | | 12/1 | \$ 20.62 |
| DF-CL60-A | 60" Clipper Aluminum Handle / Manche en aluminium « Clipper », 60 po | 7 | 15.5 | | 12/1 | \$ 22.25 |
| DF-CL54-F | 54" Clipper Fiberglass Handle – Blue / Manche de fibre de verre « Clipper », 54po, bleu | 7 | 5.5 | | 12/1 | \$ 26.85 |
| DF-CL60-F | 60" Clipper Fiberglass Handle – Blue / Manche de fibre de verre « Clipper », 60po, bleu | 7 | 5.5 | | 12/1 | \$ 29.03 |
| DF-CL60-F-Colour | 60" Clipper Fiberglass Handle – Blue / Manche de fibre de verre « Clipper », 60 po | 7.7 | 17 | | 12/1 | \$ 29.03 |
| DF-CL60-Ext | Clipper Telescopic Non Threaded Handle - 43" / 109cm Closed / Manche télescopique non fileté 43" po / 109cm | | | | 20/1 | \$ 33.33 |

SNAPPER FRAME & HANDLE / CADRE ET MANCHE «SNAPPER»

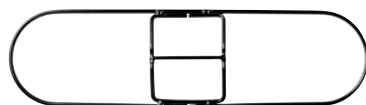

| SNAPPER FRAMES / CADRES « SNAPPER » | | | | | | |
|---|---|------|------|----|------|-----------------|
| DF-SN518 | Snapper Frame Only – 5 x 18" – 13 x 46 cm / Cadre « Snapper » seulement, 5 x 18 po / 13 x 46 cm | 11.5 | 5 | .3 | 12/1 | \$ 9.68 |
| DF-SN524 | Snapper Frame Only – 5 x 24" – 13 x 61cm / Cadre « Snapper » seulement, 5 x 24 po / 13 x 61cm | 13 | 6 | .4 | 12/1 | \$ 10.85 |
| DF-SN536 | Snapper Frame Only – 5 x 36" – 13 x 91cm / Cadre « Snapper » seulement, 5 x 36 po / 13 x 91cm | 15 | 7 | .6 | 12/1 | \$ 13.51 |
| DF-SN548 | Snapper Frame Only – 5 x 48" – 13 x 122 cm / Cadre « Snapper » seulement, 5 x 48 po / 13 x 122 cm | 22 | 10 | .8 | 12/1 | \$ 23.08 |
| DF-SN560 | Snapper Frame Only – 5 x 60" – 13 x 152 cm / Cadre « Snapper » seulement, 5 x 60 po / 13 x 152 cm | | | | 12/1 | \$ 28.16 |
| DF-SN572 | Snapper Frame Only – 5 x 72" – 13 x 182 cm / Cadre « Snapper » seulement, 5 x 72 po / 13 x 182 cm | | | | 12/1 | \$ 53.96 |
| SNAPPER HANDLE / MANCHES « SNAPPER » | | | | | | |
| DF-SN60-W | Snapper Dustmop Handle – Wood / Manche de vadrouille à épousseter « Snapper », en bois | 20.7 | 9.5 | | 10/1 | \$ 20.71 |
| DF-SN60-A | 60" Snapper Aluminum Handle / Manche en aluminium « Clipper », 60 po | 7 | 15.5 | | 10/1 | \$ 26.17 |
| DF-SN60-F | 60" Snapper Fiberglass Handle / Manche de fibre de verre « Snapper » 60 po | 20.7 | 9.5 | | 10/1 | \$ 28.20 |
| DF-SN60-M | Snapper Metal Handle / Manche en métal « Snapper » | 20.7 | 9.5 | | 10/1 | \$ 28.27 |
| DF-SN60-F-Colour | Snapper Fiberglass Handle / Manche de fibre de verre « Snapper » | 20.7 | 9.5 | | 10/1 | \$ 29.96 |
| DF-SN60-EXT | Snapper Telescopic Non Threaded Handle - 43" / 109cm Closed / Manche télescopique non fileté 43" po / 109cm | 7.8 | 3.5 | | 10/1 | \$ 47.02 |



BREAK-EZY FRAME & HANDLE / CADRE ET MANCHE «BREAK-EZY»

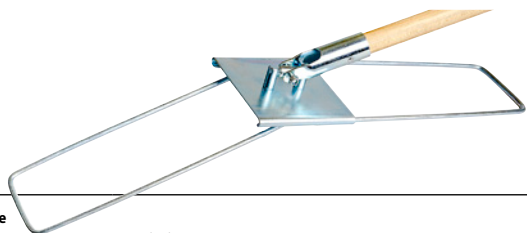

| M2 Code Code M2 | Description | Pack Wt LB (S) Poids (lb) (S) | Pack Wt KG Poids (kg) | Cubic Ft Pi3 | Pack Contenu | List Price Liste des prix |
|---------------------|---|----------------------------------|--------------------------|-----------------|-----------------|------------------------------|
| DF-EZY518 | Break-Ezy Frame Only – 5 x18” – 13 x 46 cm / Cadre « BreakEzy » seulement, 5 x18 po / 13 x 46 cm | 18.7 | 8.5 | .7 | 22/1 | \$ 26.20 |
| DF-EZY524 | Break-Ezy Frame Only – 5 x 24” – 13 x 61cm / Cadre « BreakEzy » seulement, 5 x 24 po / 13 x 61cm | 20 | 9 | .8 | 10/1 | \$ 27.45 |
| DF-EZY536 | Break-Ezy Frame Only – 5 x 36” – 13 x 91cm / Cadre « BreakEzy » seulement, 5 x 36 po / 13 x 91cm | 22 | 10 | 1.1 | 15/1 | \$ 34.94 |
| DF-EZY548 | Break-Ezy Frame Only – 5 x 48” – 13 x 122 cm / Cadre « BreakEzy » seulement, 5 x 48 po / 13 x 122 cm | 27.5 | 12.5 | 1.3 | 15/1 | \$ 38.68 |
| DF-EZY60 | Break-Ezy Wood Handle / Manche de bois “Break-Ezy” | 17 | 7.7 | | 12/1 | \$ 14.66 |
| DF-EZY518-H | Break-Ezy Frame & 60” Handle – 5 x18” – 13 x 46 cm / Cadre « BreakEzy » seulement, 5 x18 po / 13 x 46 cm | | | | 5 | \$ 44.03 |
| DF-EZY524-H | Break-Ezy Frame & 60” Handle – 5 x 24” – 13 x 61cm / Cadre « BreakEzy » seulement, 5 x 24 po / 13 x 61cm | | | | 5 | \$ 45.22 |
| DF-EZY536-H | Break-Ezy Frame & 60” Handle – 5 x 36” – 13 x 91cm / Cadre « BreakEzy » seulement, 5 x 36 po / 13 x 91cm | | | | 5 | \$ 53.55 |
| DF-EZY548-H | Break-Ezy Frame & 60” Handle – 5 x 48” – 13 x 122 cm / Cadre « BreakEzy » seulement, 5 x 48 po / 13 x 122 cm | | | | 3 | \$ 58.31 |
| DF-EZY60F - Colours | Break-Ezy Fibreglass Handle / Manche de Fibreglass “Break-Ezy” | 17 | 7.7 | | 12/1 | \$ 29.43 |
| DF-EZY60-AL | 60/152 cm Break-Ezy Aluminum Handle / Manche de bois “Break-Ezy” avec manche en aluminium - 60/152 cm | | | | 12/1 | \$ 20.63 |
| DF-EZY60-EXT | Break-Ezy Telescopic Handle Handle– Closed 68”/109 cm - Extended 68”x 172 cm / Manche télescopique Break-Ezy - fermée 68” / 109 cm - étendue 68” x 172 cm | | | | 12/1 | \$ 33.10 |

SCISSOR MOP VADROUILLE CISEAU



- Used in large warehouse, gymnasiums, airports or any open large area.
- Spans a maximum of 193 cm / 76 inch allowing you to adjust for various widths for easy passage through narrow door ways
- Scissor mop come with 2 ea 97cm / 38 inch
- Static-H dustmops that can be laundered

- Utilisé dans les grands entrepôts et les gymnases, les aéroports ou tous les grands espaces ouverts.
- Envergure de 193 cm / 76 po. permettant de s'ajuster à différentes largeurs pour le passage facile à travers des portes étroites.
- La vadrouille ciseau vient en paquet de 2 97 cm / 38 po.
- La vadrouille “Static-H” peut être lavée.

| | | | | | | |
|-------------|--|-----|-----|--|---|-----------|
| DF-SC2999FH | Scissor Mop Frame & Handle / Cadre et vadrouille en ciseau | 8.5 | 3.9 | | 1 | \$ 196.49 |
| DM-SC2999-2 | Scissor Mop Refills Includes one set (2 included) / Recharge de vadrouille en ciseau (2 incluses) | 2 | .8 | | 1 | \$ 95.48 |



Refer to page for retail packaging

Voir page pour les emballages de vente au détail

HOUSEHOLD DUSTMOP COMPLETE VADROUILLE À ÉPOUSSETER DOMESTIQUE COMPLET

| | | | | | | |
|-----------|--|-----|-----|--|------|----------|
| DM-H1216 | Household Dustmop Complete with Frame, Dustmop and 48” Handle / Ensemble domestique complet avec cadre, vadrouille et manche 48” | 5.3 | 2.4 | | 6 | \$ 25.49 |
| DM-H1216R | Household Dustmop Refill Only / Remplacement de vadrouille domestique seulement | 2 | .9 | | 12/1 | \$ 14.56 |
| DM-H1216F | Household Dustmop Frame Only / | | | | 6/1 | \$ 16.39 |



Refer to page for retail packaging

Voir page pour les emballages de vente au détail

ALL-IN-ONE DUSTMOPS COMBOS / ENSEMBLE VADROUILLE À ÉPOUSSETER

| | | | | | | |
|-----------|---|-----|-----|-----|---|-----------|
| DM-ALO518 | All-In-One Dust Mop Combos – 5 x18”/46cm x 13 cm – Blue / Ensemble vadrouille à épousseter, 5 x18 po/46cm x 13 cm, bleu | 2.9 | 1.2 | .70 | 1 | \$ 54.49 |
| DM-ALO524 | All-In-One Dust Mop Combos – 5 x 24”/61cm x 13 cm – Blue / Ensemble vadrouille à épousseter, 5 x 24 po/61cm x 13 cm, bleu | 3 | 1.4 | .70 | 1 | \$ 65.26 |
| DM-ALO536 | All-In-One Dust Mop Combos – 5 x 36”/91 cm x 13 cm – Blue / Ensemble vadrouille à épousseter, 5 x 36 po/91 cm x 13 cm, bleu | 4 | 1.8 | .70 | 1 | \$ 82.40 |
| DM-ALO548 | All-In-One Dust Mop Combos – 5 x 48”/122 cm x 13 cm – Blue / Ensemble vadrouille à épousseter, 5 x 48 po/122 cm x 13 cm, bleu | 5 | 2.3 | .70 | 1 | \$ 108.99 |

DOODLE BUG WALL WASHING SYSTEMS / SYSTÈMES DE LAVAGE DES MURS DOODLE BUG

- Doodle bugs are made of strong plastic available in two size 9" & 11"
- 9" has a universal handle design
- 11" has a threaded handle design
- Can be used to scrub and wash walls and tight areas

- Fabriqués en plastique robuste; deux tailles (9 po et 11 po)
- Le système 9 po a un manche universel.
- Le système 11 po a un manche fileté.
- Pour frotter et laver les murs et les zones difficiles à atteindre



Accepts threaded handle / Accepte la poignée fileté



WW-1749 Accepts any 15/16" Handle / Accepte tout poignée 15/16"

To Wring Out Doodle Bug Refer To Page -----
Pour essorer la vadrouille "Doodle Bug" se référer -----



| M2 Code Code M2 | Description | Pack Wt LB (S) Poids (lb) (S) | Pack Wt KG Poids (kg) | Cubic Ft Pi3 | Pack Contenu | List Price Liste des prix |
|--------------------|--|----------------------------------|--------------------------|-----------------|-----------------|------------------------------|
| WW-1749 | 9" Doodle Bug – Frame only / Cadre « Doodle Bug » seulement, 9 po | 19 | 8.6 | 1.5 | 12/1 | \$ 14.54 |
| WW-17411 | 11" Doodle Bug – Frame only – Accepts Threaded Handle / Cadre « Doodle Bug » seulement, 11 po, s'adapte au manche fileté | 18 | 8. | 1.4 | 12/1 | \$ 14.77 |

DOODLE BUG WALL WASHING REFILLS / RECHARGES POUR LAVAGE DE MURS «DOODLE BUG»

CUT END & LOOPED END MICROFIBER

- Refills are absorbent and long lasting
- Velcro backing securely attaches the refill to the frame

MICROFIBRE À BRINS COUPÉS OU BOUCLÉS

- Recharge sont absorbent et durable
- Le revers en velcro attache solidement la recharge au cadre.



Microfiber / Microfibre



| DOODLE BUG - MICROFIBER - CUT END / BRINS COUPÉS - Grey/Gris | 1 | 2 | 3 | 4 | 5 | 6 | 7 | 8 | 9 | 10 |
|--|---|---|---|---|---|---|---|---|---|----|
| Durability / Durabilité | | | | | | | | | | |
| Dust Capture / Capture de poussière | | | | | | | | | | |
| Launderability / Blanchiment | | | | | | | | | | |
| Performance / Performance | | | | | | | | | | |

| DOODLE BUG - MICROFIBER - LOOPED / FRANGES BOUCLÉES - Blue/Bleu | 1 | 2 | 3 | 4 | 5 | 6 | 7 | 8 | 9 | 10 |
|---|---|---|---|---|---|---|---|---|---|----|
| Durability / Durabilité | | | | | | | | | | |
| Dust Capture / Capture de poussière | | | | | | | | | | |
| Launderability / Blanchiment | | | | | | | | | | |
| Performance / Performance | | | | | | | | | | |

| DOODLE BUG - COTTON - CUT END / BRINS COUPÉS | 1 | 2 | 3 | 4 | 5 | 6 | 7 | 8 | 9 | 10 |
|--|---|---|---|---|---|---|---|---|---|----|
| Durability / Durabilité | | | | | | | | | | |
| Dust Capture / Capture de poussière | | | | | | | | | | |
| Launderability / Blanchiment | | | | | | | | | | |
| Performance / Performance | | | | | | | | | | |

| | | | | | | | | | | | | |
|-------------|--|-----|---|--|--|--|--|--|--|--|------|----------|
| WW-18411-GY | 12" / 30 cm Doodle Bug Cut End - Refill Only Microfiber - Velcro - Grey | | | | | | | | | | 12/1 | \$ 17.03 |
| WW-18411-BL | 12" / 30 cm Doodle Bug Cut End - Refill Only Microfiber - Velcro - Blue | | | | | | | | | | 12/1 | \$ 17.03 |
| | 12" / 30 cm Doodle Bug Cut End - Refill Only Microfiber - Velcro - Red | | | | | | | | | | 12/1 | \$ 17.03 |
| WW-18411-GN | 12" / 30 cm Doodle Bug Cut End - Refill Only Microfiber - Velcro - Green | | | | | | | | | | 12/1 | \$ 17.03 |
| WW-18411-YE | 12" / 30 cm Doodle Bug Cut End - Refill Only Microfiber - Velcro - Yellow | | | | | | | | | | 12/1 | \$ 17.03 |
| WW-18412 | 10" / 25 cm Doodle Bug Cut End - Refill Only Cotton - Velcro | | | | | | | | | | 12/1 | \$ 17.95 |
| WW-18413 | 10" / 25 cm Doodle Bug Cut End - Frame & Refill - Cotton - Velcro | | | | | | | | | | 12/1 | \$ 17.95 |
| WW-1849 | 9" / 22 cm Doodle Bug Microfiber Refill only - Velcro - Cut End - Grey / 9 po / 22 cm Recharge en microfibre "Doodle Bug" seulement, brins coupés - gris | 4.2 | 2 | | | | | | | | 12/1 | \$ 15.41 |
| WW-1850 | 9" / 22 cm Doodle Bug Microfiber Refill only - Looped End / 9 po / 22 cm Recharge en microfibre "Doodle Bug" seulement - Brins bouclés | 4.2 | 2 | | | | | | | | 12/1 | \$ 15.74 |
| MFP-4010-BL | 11" / 28cm MicroFiber Pads - Blue / Tampons M-Fibre 11" / 28cm - bleu | | | | | | | | | | 12/1 | \$ 9.96 |
| WW-940-01 | 3.5 x 7.5" Microfiber with Key Hole tie on style for Metal Frame - Refill Only / Microfibre avec trou pour oeillet pour cadre métallique - 3.5 x 7.5" - recharge seulement | | | | | | | | | | 12/1 | \$ 15.41 |
| WW-940-02 | 3.5 x 7.5" Cotton with Key Hole tie on style for Metal Frame - Refill Only / Cotton avec trou pour oeillet pour cadre métallique - 3.5 x 7.5 po - recharge seulement | | | | | | | | | | 12/1 | \$ 15.32 |



DUSTERS / BROSSES À POUSSIÈRE

MICROFIBER / MICROFIBRE

Dusters can be used for high dusting and to clean difficult to reach areas
 À utiliser pour dépeussier en hauteur et dans les endroits difficiles à atteindre.

* Handles Sold Separately
 * FH-A3180 on Page

* Le manche est vendu séparément
 * FH-A3180 à la page



| M2 Code Code M2 | Description | Pack Wt LB (S) Poids (lb) (S) | Pack Wt KG Poids (kg) | Cubic Ft Pi3 | Pack Contenu | List Price Liste des prix |
|--------------------|--|----------------------------------|--------------------------|-----------------|-----------------|------------------------------|
| DU-M8500 | Duster-Frame Flexible – 22" / 55 cm / Support de dépeussierage microfibre souple, 22 po / 55 cm | .7 | .4 | 3 | 12/1 | \$ 20.28 |
| DU-M8501 | Microfiber Refill Sleeve – 22" 55 cm - blue / Rechange manchon de dépeussierage microfibre, 22 po / 55 cm - bleu | .2 | .09 | 4 | 12/1 | \$ 14.08 |
| DU-M8502 | Microfiber Duo Refill Sleeve – 22" 55 cm - Grey / Rechange microfibre Duo - 22"/55cm - gris | .2 | .09 | 4 | 12/1 | \$ 35.64 |
| DU-M8503 | Microfiber Duo Sided Cut Fiber/w/Fringe Refill Sleeve-Green – 22" 55 cm / Microfibre 2 cotés avec bout coupé/bande de rechange verte 22" 55 cm | .2 | .09 | 4 | 12/1 | \$ 24.69 |
| FH-A3180 | Telescopic Non Threaded Handle - 100 -180 cm / Manche télescopique non fileté 100"/180 cm | | | | 20/1 | \$ 20.97 |

DUSTERS / PLUMEAUX

DUSTING BRUSH /
 Brosse à épousseter



PIPE DUCT BRUSH /
 Brosse pour tuyaux

Bendable head to wrap around pipes /
 Pliable pour entourer les tuyaux

TAKES STANDARD
 ACME HANDLE WITH
 ADAPTER

UTILISE UNE POIGNÉE
 STANDARD ACME
 AVEC ADAPTEUR

| M2 Code Code M2 | Description | Pack Wt LB (S) Poids (lb) (S) | Pack Wt KG Poids (kg) | Cubic Ft Pi3 | Pack Contenu | List Price Liste des prix |
|--------------------|---|----------------------------------|--------------------------|-----------------|-----------------|------------------------------|
| WS-AC005 | Ceiling Fan Dusting Brush / Brosse à épousseter | 3.3 | 1.5 | .77 | 10/1 | \$ 16.98 |
| WS-AC006 | Pipe Duct Brush / Brosse pour tuyaux | 2.9 | 1.3 | .77 | 20/1 | \$ 22.64 |



| M2 Code Code M2 | Description | Pack Wt LB (S) Poids (lb) (S) | Pack Wt KG Poids (kg) | Cubic Ft Pi3 | Pack Contenu | List Price Liste des prix |
|--------------------|---|----------------------------------|--------------------------|-----------------|-----------------|------------------------------|
| FH-A35 | Threaded to Tapered Adapter / Adaptateur conique fileté | | | | 12/1 | \$ 3.37 |
| FH-W360-1T | Tapered 1" x 60" / À bout fuselé 1 po x 60 po | 37.5 | 17 | 1 | 25/12 | \$ 7.91 |

DUSTERS / PLUMEAUX

FLEXIBLE LAMBS WOOL DUSTER / PLUMEAU EN LAINE D'AGNEAU

- 26" Lamb's wool duster acts like a magnet to attract dust
- Can be hand washed
- Le plumeau en laine d'agneau qui agit comme un aimant attire la poussière 26 po. • Peut être lavé à la main

LAMBS WOOL DUSTER / PLUMEAU EN LAINE D'AGNEAU

- 44" Telescopic Handle
- Ideal for hard to reach places
- Manche télescopique, 44 po
- Idéal pour les endroits difficilement accessibles

TELESCOPIC MICROFIBER DUSTER / PLUMEAU SOUPLE EN LAINE D'AGNEAU

- 50" Telescopic Handle
- Ideal for hard to reach places



| M2 Code Code M2 | Description | Pack Wt LB (S) Poids (lb) (S) | Pack Wt KG Poids (kg) | Cubic Ft Pi3 | Pack Contenu | List Price Liste des prix |
|--------------------|---|----------------------------------|--------------------------|-----------------|-----------------|------------------------------|
| DU-L524 | Lambs wool duster - 26" / 66 cm / Plumeau souple en laine d'agneau, 26 po / 66 cm | .25 | .1 | 3 | 12 | \$ 13.88 |
| DU-L524-2 | Lambs wool duster - 26" / 66 cm / Plumeau souple en laine d'agneau, 26 po / 66 cm | | | | 12 | \$ 29.47 |
| DU-L525 | Lambs wool duster with 44" / 111 cm telescopic handle - 32" / 81cm Closed / Plumeau en laine d'agneau avec un manche télescopique de 44 po / 111 cm, 32 po / 81cm fermé | 42 | 19.5 | 5 | 12 | \$ 17.50 |
| DU-L525-2 | Telescopic Extra Large Lambs Wool Duster - Ext 44"/111cm - Closed 32" / 81cm / | | | | 12 | \$ 22.40 |
| DU-L527 | Telescopic Microfiber Duster - 63" / 160 cm - Closed 41" / 104 cm Dépoussiérage microfibre avec un manche télescopique de - 63"/160 cm - 32 po / 81cm fermé | .25 | .1 | 3 | 12 | \$ 24.29 |
| DU-L528 | Lambs Wool duster with Extra Long Flexible Head - Telescopic Handle - Overall Length Closed 55" - Open 74" | | | | | \$ 35.37 |

SUPERIOR OSTRICH FEATHER DUSTER / UN PLUMEAU EN PLUMES D'AUTRUCHE DE QUALITÉ SUPÉRIEURE

Ideal for dusting fine delicate objects, plants and ornaments. They can also be used for cleaning blinds, light fixtures and store shelves.

Idéaux pour dépoussiérer les objets délicats, les plantes et les décorations. Ils peuvent également être utilisés pour nettoyer les stores, les luminaires et les étagères.



Complete unit / Ensemble complet



Refill

| | | | | | | |
|-----------|--|----|-----|---|------|----------|
| DU-F1224 | Superior Ostrich Feather Duster - 26" / 66 cm / Plumeau en plumes d'autruche supérieur - 26 po / 66 cm | | | | 12 | \$ 22.02 |
| DU-SY4572 | Curved Frame Duster complete with Telescopic Handle and Refill / Support de dépoussiérage incurvé avec manche télescopique et recharge | 18 | 8.5 | 2 | 12/1 | \$ 22.68 |
| DU-SY4573 | Curved Frame Duster Refill - Microfiber - Blue / Recharge pour cadre incurvé Microfibre - bleu | | | | 12/1 | \$ 16.64 |

OIL TREATED DUST CLOTH / CHIFFON À POUSSIÈRE TRAITÉ À L'HUILE

M2 Dust Cloths are treated with mineral oil to attract and retain dirt and dust particles without leaving lint or residue. The cloth is a magnet for dust and dirt. It will leave surfaces clean without the use of sprays and their costs associated with the addition of chemicals.

Les chiffons anti-poussière M2 sont traités avec de l'huile minérale pour attirer et retenir les particules de saleté et de poussière sans laisser de peluches ou de résidus. Le tissu est un aimant pour la poussière et la saleté. Il va laisser les surfaces propres sans l'utilisation de vaporisateur et leurs coûts associés avec l'ajout de produits chimiques



| OIL TREATED DUSTCLOTH / CHIFFON À POUSSIÈRE TRAITÉ À L'HUILE | | | | | | |
|--|---|----------------------|--|--|----------------------|----------|
| FS-9224-YE | Oil Treated Dustcloths - 24" x 24" / 61 x 61 cm - Yellow Chiffon à poussière traité à l'huile - 24" x 24" / 61 x 61 cm - Jaune | Average Wt 15 lbs | | | 50 Bags/ Case 500 | \$ 41.85 |



WASHROOM CARE / ENTRETIEN DES SALLES D'EAU



Available for
Disponible pour
PRIVATE LABEL
ÉTIQUETTE
PRIVÉE

TRIGGER SPRAYERS / PULVÉRISATEUR À GACHETTE



- Nozzle can be adjusted for a fine spray or a jet stream
- Adjustable locking nozzle
- Dip tube filter
- Buse réglable (bruine ou jet continu)
- Buse de blocage réglable
- Tube plongeur avec filtre

| M2 Code Code M2 | Description | Pack Wt LB (S) Poids (lb) (S) | Pack Wt KG Poids (kg) | Cubic Ft Pi3 | Pack Contenu | List Price Liste des prix |
|--------------------|--|----------------------------------|--------------------------|-----------------|-----------------|------------------------------|
| TS5911RD | Red & White Trigger Sprayer – 28/400 1.5cc / Pulvérisateur à gâchette rouge et blanc 28/400 1.5 cc | 24 | 11 | 2.6 | 350 | \$ 2.36 |
| TS5911WH | White & White Trigger Sprayer – 28/400 1.5cc / Pulvérisateur à gâchette blanc et blanc 28/400 1.5 cc | 24 | 11 | 2.6 | 420 | \$ 2.36 |
| TS5911BL | Blue & White Trigger Sprayer – 28/400 1.5cc / Pulvérisateur à gâchette blue et blanc 28/400 1.5 cc | 24 | 11 | 2.6 | 350 | \$ 2.36 |
| TS5914GN | Green & White Heavy Duty Trigger Sprayer – 28/400 2.5cc / | | | | 300 | \$ 3.00 |



- Ergonomic Sprayer comes complete with remote 36" (90 cm) dip tube
- Ideal for hard to reach areas

- Le pulvérisateur ergonomique comprend un tube plongeur de 36" (90 cm)
- Idéal pour les endroits difficiles à atteindre



| M2 Code Code M2 | Description | Pack Wt LB (S) Poids (lb) (S) | Pack Wt KG Poids (kg) | Cubic Ft Pi3 | Pack Contenu | List Price Liste des prix |
|--------------------|---|----------------------------------|--------------------------|-----------------|-----------------|------------------------------|
| TS5930-WH | White & White Standard Trigger Sprayer - On/Off Spray or Mist– 28/400 | | | | 500 | \$ 2.19 |
| TS5932-RD | Red & White Standard Duty Trigger Sprayer - Steam or Mist– 28/400 | | | | 350 | \$ 1.69 |
| TS6019 | Chemical Resistant Trigger Sprayer with Viton Rubber O Ring / Gâchette-pulvérisateur résistante aux produits chimiques | | | | 200/1 | \$ 4.56 |

SPRAY BOTTLES & JUGS / PULVÉRISATEURS ET BIDONS



| M2 Code Code M2 | Description | Pack Wt LB (S) Poids (lb) (S) | Pack Wt KG Poids (kg) | Cubic Ft Pi3 | Pack Contenu | List Price Liste des prix |
|--------------------|--|----------------------------------|--------------------------|-----------------|-----------------|------------------------------|
| TS-B16 | 16 oz. Cylindrical bottle 28/400 Neck / Bouteille cylindrique, cou 28/400 - 16 oz | 10.6 | 4.6 | 6.6 | 248 | \$ 0.94 |
| TS-B2301 | 1L Cylindrical bottle 28/400 Neck - Natural / 1L Bouteille cylindrique, cou 28/400 - Naturelle | | | | 104 | \$ 1.30 |
| TS-B2301-WH | 1L Cylindrical bottle 28/400 Neck - White / 1L Bouteille cylindrique, cou 28/400 - blanc | | | | 104 | \$ 1.32 |
| TS-B289-ER | 24 oz. Round bottle 28/400 Neck - Natural E / | 10.6 | 4.6 | 6.6 | 147 | \$ 1.07 |
| TS-B289W-2 | 24 oz. Round bottle with WHMIS 28/40 | 10.6 | 4.6 | 6.6 | 147 | \$ 1.50 |
| TS-B290-2 | 32 Oz. Round bottle 28/400 - Natural 2 / | 15.8 | 7.2 | 6.6 | 128 | \$ 1.46 |
| TS-B290W-2 | 32 oz. Round bottle with WHMIS 28/400 1L/32 oz | 15.8 | 7.2 | 6.6 | 121 | \$ 1.92 |
| TS-B2300 | 32 Oz. Bottle Carafe Style 1L/32oz - 28/400 Neck - Natural / Bouteille style carafe - cou 28/400 - 1L/32oz - naturelle | 15 | 6.8 | 6.6 | 104 | \$ 1.35 |
| TS-B2300W | 32 Oz. Bottle Carafe Style 1L/32oz - 28/400 Neck - White / Bouteille style carafe - cou 28/400 - 1L/32oz - blanc | 15 | 6.8 | 6.6 | 104 | \$ 1.37 |



| M2 Code Code M2 | Description | Pack Wt LB (S) Poids (lb) (S) | Pack Wt KG Poids (kg) | Cubic Ft Pi3 | Pack Contenu | List Price Liste des prix |
|---|--|----------------------------------|--------------------------|-----------------|-----------------|------------------------------|
| TS-B289W-PL | 24 oz. Round bottle with Private Label/- 28/400 Neck Bouteille ronde - cou 28/400 - 24 oz avec | 10.6 | 4.8 | 6.6 | 128/Case | \$ 1.82 |
| TS-B290W-PL | 32 oz. Round bottle with Private Label 28/400 Neck/ Bouteille ronde - cou 28/400 - 32 oz avec | 15.8 | 7.2 | 6.6 | 128/Case | \$ 2.19 |
| TS-B2300-PL | 32 Oz. Bottle Carafe Style Private Label - 1L/32oz 28/400 Neck / Bouteille style carafe - cou 28/400 - 1L/32oz - avec | 15 | 6.8 | 6.6 | 104/Case | \$ 2.63 |
| BOTTLE AND TRIGGER SPRAYER COMBOS / BOUTEILLE ET COMBOS PULVÉRISATEUR À GÂCHETTE | | | | | | |
| TS-BT289-12 | 24 oz Round Bottle with TS5911R Trigger Sprayer 1.5cc / 24 oz bouteille ronde avec TS5911R pulvérisateur à gâchette 1.5cc | | | | 12/Case | \$ 3.24 |
| TS-BT289W-12 | 24 oz Round Bottle with WHMIS and TS5911R Trigger Sprayer 1.5cc / 24 oz bouteille ronde avec WHMIS et TS5911R pulvérisateur à gâchette 1.5cc | | | | 12/Case | \$ 3.80 |
| TS-BT289-12-2 | 24 oz Round Bottle with TS5930R Trigger Sprayer 1.5cc / 24 oz bouteille ronde avec TS5930R pulvérisateur à gâchette 1.5cc | | | | 12/Case | \$ 3.24 |
| TS-BT290-12 | 32 oz Round Bottle with TS5911R Trigger Sprayer 1.5cc / 32 oz bouteille ronde avec TS5911R pulvérisateur à gâchette 1.5cc | | | | 12/Case | \$ 3.25 |
| TS-BT290W-12 | 32 oz Round Bottle with WHMIS and TS5911R Trigger Sprayer 1.5cc / 32 oz bouteille ronde avec WHMIS et TS5911R pulvérisateur à gâchette 1.5cc | | | | 12/Case | \$ 4.19 |
| TS-BT290-12-2 | 32 oz Round Bottle with TS5930R Trigger Sprayer 1.5cc / 32 oz bouteille ronde avec TS5930R pulvérisateur à gâchette 1.5cc | | | | 12/Case | \$ 3.25 |

JUGS / BIDONS



| M2 Code Code M2 | Description | Bulk Pack Poids (lb) (5) | Pack Wt LB (5) Poids (lb) (5) | Pack Wt KG Poids (kg) | Cubic Ft Pi3 | Pack Contenu | List Price Liste des prix |
|--------------------|---|-----------------------------|----------------------------------|--------------------------|-----------------|-----------------|------------------------------|
| TS-B2400-Bulk | 4L Square Jug – 38/400 – Natural -Bulk / Bidon carré, 4L, 38/400, naturel | 336 | 10.5 | 4.8 | .66 | 336/Skid | \$ 2.12 |
| TS-6000 | 1 oz Gallon Pump – 38/400-White / Pompe, gallon 1 oz, 38/400 - blanc | | 24 | 11 | 2.6 | 200/25 | \$ 2.83 |
| TS-6002 | 1 oz Gallon Pump – 38/400-White / Pompe, gallon 1 oz, 38/400 - blank | | 24 | 11 | 2.6 | 200/25 | \$ 4.95 |
| TS-6010 | 2 cc Lotion Pump 28/400 - White | | 24 | 11 | 2.6 | 1000 | \$.71 |

CAPS / BOUCHON



TS-B2700

TS-B2701



TS-B2710

TS-B2711



TS-B2720



TS-B2721



| M2 Code Code M2 | Description | Pack Wt LB (5) Poids (lb) (5) | Pack Wt KG Poids (kg) | Cubic Ft Pi3 | Pack Contenu | List Price Liste des prix |
|--------------------|---|----------------------------------|--------------------------|-----------------|-----------------|------------------------------|
| TS-B2700 | 4L US Gal. Big Cap - 38/400 – White / Gros bouchon 4L US - 38/400 - blanc | 20 | 9 | 1.8 | 2500/25 | \$.17 |
| TS-B2738 | 4L US Gal. Cap – White 38/400 B/Liner / | 20 | 9 | 1.8 | 3200/25 | \$.24 |
| TS-B2700-V | 4L US Gal. Cap – White 38/400 Big Cap with Vented Liner | 20 | 9 | 1.8 | 2500/25 | \$ 2.27 |
| TS-B2701 | Small Cap - 28/400 – White / Petit bouchon - 28/400 - blanc | 20 | 9 | 1.8 | 4675/25 | \$.17 |
| TS-B2710 | Child Resistant Cap - 28/400 – White - Lined / Bouchon résistant aux enfants - 28/400 - blanc - Doublé | 20 | 9 | 1.2 | 1700/25 | \$.45 |
| TS-B2711 | Child Resistant Cap - 38/400 – White - Lined / Bouchon résistant aux enfants - 38/400 - blanc - Doublé | 20 | 9 | 1.2 | 950/25 | \$.48 |
| TS-B2720 | Dispensing Lock Top for 1 L Caraf and 16 oz Bottle Only - 28/400 – White / Distribution à verrou pour 1 L Caraf et 16 oz Bouteille Seulement - 28/400 - blanc | 20 | 9 | 1.2 | 1800/25 | \$.90 |
| TS-B2721 | Dispensing Flip Cap – Ketchup Style - 28/400 – White / Bouchon articulé - Style Ketchup - 28/400 - blanc | 20 | 9 | 1.2 | 3500/25 | \$.43 |
| TS-PP6000 | 12 x 1L Pump Up Sprayer | | | | 15 | \$ 14.45 |
| TS-PP6000 | Pump up Sprayer / Vaporisateur à pompe - 600mL | 12.5 | 5.7 | 2.4 | 15 | \$ 12.26 |



WASHROOM CARE / POUR LA SALLE DE BAIN

Two (2) "D" Size batteries required - Not included / Deux batteries "D" requises, non incluses

AIR-MIST DISPENSER

- Air-Mist dispenser has a smooth design can be adjusted for different spray times
- Easy to install

DISTRIBUTEUR D'ODEUR AUTOMATIQUE

- Le distributeur Air-Mist est de conception lisse et peut être ajusté pour différent temps de pulvérisation.
- Facile à installer



| M2 Code Code M2 | Description | Pack Wt LB (S) Poids (lb) (S) | Pack Wt KG Poids (kg) | Cubic Ft Pi3 | Pack Contenu | List Price Liste des prix |
|--------------------|---|----------------------------------|--------------------------|-----------------|-----------------|------------------------------|
| WA-AR500 | Air-Mist Dispenser / Distributeur d'odeur automatique | 1 | .5 | | 40/1 | \$ 56.68 |
| WA-AR501 | Air-Mist Dispenser Refill – Fruity Citrus / Recharge distributeur d'odeur automatique d'air - Fruité/Citron | 8 | 3.6 | | 12 | \$ 7.51 |
| WA-AR502 | Air-Mist Dispenser Refill – Apple / Recharge distributeur d'odeur automatique d'air - Pomme | 8 | 3.6 | | 12 | \$ 7.51 |
| WA-AR503 | Air-Mist Dispenser Refill – Cherry/Berry / Recharge distributeur d'odeur automatique d'air - Cerise / Baie | 8 | 3.6 | | 12 | \$ 7.51 |
| WA-AR504 | Air-Mist Dispenser Refill – Lemon/Lime / Recharge distributeur d'odeur automatique d'air - Citron / Citron vert | 8 | 3.6 | | 12 | \$ 7.51 |
| WA-AR505 | Air-Mist Dispenser Refill – Baby Fresh / Recharge distributeur d'odeur automatique d'air - Bébé frais | 8 | 3.6 | | 12 | \$ 7.51 |
| WA-AR506 | Air-Mist Dispenser Refill – Ocean Morning / Recharge distributeur d'odeur automatique d'air - Ocean Matin | 8 | 3.6 | | 12 | \$ 7.51 |
| WA-AR507 | Air-Mist Dispenser Refill – Fresh Linen / Recharge distributeur d'odeur automatique d'air –air mist linge frais | 8 | 3.6 | | 12 | \$ 7.51 |
| WA-AR508 | Air Mist Dispenser Refill - Mango - Recharge distributeur d'odeur d'air - Mango | 8 | 3.6 | | 12 | \$ 7.51 |

AEROSOL CLEANERS / NETTOYANTS EN AÉROSOL



| M2 Code Code M2 | Description | Pack Wt LB (S) Poids (lb) (S) | Pack Wt KG Poids (kg) | Cubic Ft Pi3 | Pack Contenu | List Price Liste des prix |
|--------------------|---|----------------------------------|--------------------------|-----------------|-----------------|------------------------------|
| AR-GL9200 | Glass Cleaner/ Nerroyant à Vitres - 500 g | | | | 12 | \$ 17.06 |
| AR-FU9202 | Furniture Polish - Lemon/ Poli à Meubles - limon -496 g | | | | 12 | \$ 23.41 |
| AR-ST9203 | Stainless Steel/ Nettoyant Pour Acier Inoxydable - 397 g | | | | 12 | \$ 26.18 |
| AR-AP9204 | All Purpose Cleaner/Nettoyant à Tout Usage - 539 g | | | | 12 | \$ 17.79 |
| AR-OV9205 | Grill & Oven Cleaner/Nettoyant pour grilles et four - 510 g | | | | 12 | \$ 21.51 |
| AR-OA9206 | Orange Attack Odour Neutralizer / Neutralisateur d'odeur – Attaque d'orange - 369 g | | | | 12 | \$ 36.55 |

**FOAM SOAP DISPENSE
DISTRIBUTEUR DE SAVON-MOUSSE
1000ML/33OZ**

- Used for soap/sanitizer/shower gel
- Wall mounted
- Includes Foam Tape and Screws
- Keyless but lockable
- Utilisé pour savon, désinfectant ou gel douche
- Incluant mousse, ruban adhésif et vis, sans clé mais verrouillable



**LOTION SOAP DISPENSE
DISTRIBUTEUR DE SAVON EN LOTION
1000ML/33OZ**

- Wall mounted
- Includes Foam Tape and Screws
- Keyless but lockable
- Utilisé pour savon, désinfectant ou gel douche
- Incluant mousse, ruban adhésif et vis, sans clé mais verrouillable

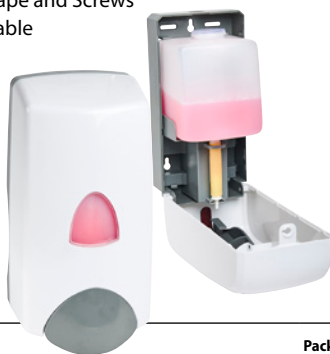

**MANUAL LOTION SOAP DISPENSER
"CLEARVIEW"
DISTRIBUTEUR DE SAVON EN LOTION
MANUEL "CLEARVIEW"
1000ML/33OZ**

- Used for Liquid Sanitizer, Liquid Soap, Liquid Shower Gel and Alcohol
- Utilisé pour les désinfectant liquide, le savon liquide, le gel douche liquide et l'alcool



| M2 Code Code M2 | Description | Pack Wt LB (S) Poids (lb) (S) | Pack Wt KG Poids (kg) | Cubic Ft Pi3 | Pack Contenu | List Price Liste des prix |
|--------------------|---|----------------------------------|--------------------------|-----------------|-----------------|------------------------------|
| WA-SD710 | Foam Soap Dispenser 1000ml/33oz – Large-White / Distributeur de savon-mousse 1000ml/33 oz. Ensemble mural blanc | | | | 24/1 | \$ 41.26 |
| WA-SD711 | Lotion Soap Dispenser 1000ml/33oz – Large-White / Distributeur de savon en lotion 1000 ml/33 oz. Ensemble mural blanc | | | | 24/1 | \$ 41.26 |
| WA-SD712 | Manual Lotion Soap Dispenser – ClearView 1000ml/33oz / Distributeur de savon en lotion manuel "Clear view" 1000 ml/33 oz. | | | | 30/1 | \$ 37.72 |

TOUCHLESS LIQUID DISPENSER - 1000/32 OZ

Touchless - No Longer need to touch Liquid Soap Dispenser – just position hand under the sensor and the infrared sensor will automatically dispense soap, sanitizer, disinfectant or any other liquids of your choice.



**TOUCHLESS FOAM/SOAP DISPENSER
1000/33 OZ**

Touchless - No Longer need to touch Foam Dispenser – just position hand under the sensor and the infrared sensor will automatically dispense soap, sanitizer, disinfectant or any other low viscosity liquids of your choice.



HAND SANITIZER STATION

- Dispenser Stands
- Constructed of durable stainless steel
- Adjustable from 48"/122cm to 66"/167cm
- Easy-to-clean drip tray
- Extra long mounting surface



Battery Compartment
(6 AA Batteries not included)

| | | | | | | |
|------------|--|--|--|--|------|-----------|
| WA-SD962-L | Touchless Liquid Dispenser - Large - 1000ml/33oz - White -Wall Mounted - Including Foam Tape & Screws. Keyless but lockable. AA Battery. 1,2,3 Drops for Settin - Use with Alcohol Gel, Sanitizer, Disinfectant or Hand Soap | | | | 12/1 | \$ 106.66 |
| WA-SD963-F | Touchless Foam Dispenser - Large - 1000ml/33oz - White Wall Mounted - Including Foam Tape & Screws. Keyless but lockable. AA Battery. 1,2,3 Drops for Setting - Use with Alcohol Gel, Sanitizer, Disinfectant or Hand Soap | | | | 12/1 | \$ 106.66 |
| WA-SDS1 | Display Stand Only - Maximum Height 66 inches / 1.5 meters | | | | 2/1 | \$ 207.70 |

**BOWL BRUSH WIRE CENTRE /
BROSSE À CUVETTES AVEC BROCHE TORSADÉE**

- Ergonomically designed handle for superior scrubbing power
- Manche ergonomique, grand pouvoir nettoyant



15.5" /40 cm

**BOWL & CADDY /
BROSSE À CUVETTES ET PORTE-BROSSE**

- Caddy for easy storage
- Ideal for superior scrubbing power
- Porte-brosse pour rangement facile
- Grand pouvoir nettoyant

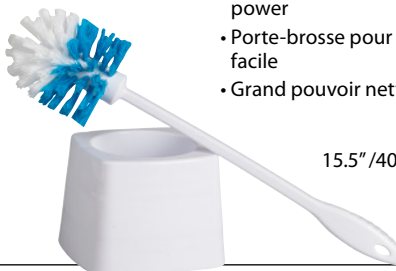

15.5" /40 cm

**BOWL BRUSH /
BROSSE À CUVETTES**

- Ergonomically designed handle
- Superior scrubbing power
- Manche ergonomique
- Grand pouvoir nettoyant



15.5" /40 cm

| | | | | | | |
|------------|---|-----|-----|-----|----|---------|
| BR-WM202 | Bowl Brush with Twisted Wire Centre – Poly Pro Bristles / Brosse à cuvettes avec broche torsadée, fibres de polypropylène | 3.5 | 1.5 | 1 | 12 | \$ 5.26 |
| BR-WM203 | Bowl Brush with Caddy – Poly Pro Bristles / Brosse à cuvettes avec porte-brosse, fibres de polypropylène | 8 | 4 | 1.6 | 24 | \$ 7.96 |
| BR-WM203-C | Bowl Brush Caddy / Panier à brosses | | | | 24 | \$ 4.89 |
| BR-WM204 | Bowl Brush Only – Poly Pro Bristles / Brosse à cuvettes seulement, fibres de polypropylène | 2 | 1 | .4 | 24 | \$ 5.26 |



**ACRYLIC BOWL SWAB /
LAVETTE À CUVETTES ACRYLIQUE**

- Economical acid resistant bowl swab attached to a strong handle
- Fast drying acrylic yarn will not drip
- Lavette à cuvettes économique, résistante à l'acide fixée et munie d'un manche robuste
- Fibres synthétiques à séchage rapide, ne goutte pas



**BOWL SWAB WITH CUP /
LAVETTE À CUVETTES ET PORTE-LAVETTE**

- Economical acid resistant bowl swab attached to a strong handle
- Sliding Cone squeezes yarn to remove excess liquids
- Lavette à cuvettes économique et résistante à l'acide fixée à un manche robuste
- Le cône mobile essore la lavette pour en éliminer l'excès de liquide.



**TUB SCRUBBER /
ÉPURATEUR POUR BAIGNOIRE**

- Bathtubs & Enclosures,
- Ceramic Tiles
- Hot Tubs and Swimming Pools
- Marine and Recreational Vehicles
- Baignoires et enclos

- Carreaux en céramiques
- Jacuzzis et piscines
- Marine et véhicules récréatifs



| M2 Code Code M2 | Description | Pack Wt LB (S) Poids (lb) (S) | Pack Wt KG Poids (kg) | Cubic Ft Pi3 | Pack Contenu | List Price Liste des prix |
|--------------------|---|----------------------------------|--------------------------|-----------------|-----------------|------------------------------|
| WA-209 | Acrylic bowl swab / Lavette à cuvettes acrylique | 11 | 5 | 1.2 | 100 | \$ 1.70 |
| WA-210 | Acrylic bowl swab with cup / Lavette à cuvettes acrylique et porte-lavette | 15.5 | 7 | 1.6 | 100/10 | \$ 2.98 |
| TB-96000 | Tub Scrubber with 48" Metal Handle / Épurateur pour baignoire - manche de métal blanc 48 po | | | | 12 | \$ 20.03 |

BOWL CADDY / SUPPORT À LAVETTE ET BOUTEILLE DE TOILETTE

IDEAL FOR STORING BOWL BRUSH BETWEEN CLEANINGS. DESIGNED TO HOLD A QUART SIZE BOTTLE OF CLEANER AND BOWL SWAB.

IDÉAL POUR STOCKER LA BROsse DE TOILETTE ENTRE LES NETTOYAGES. CONÇU POUR TENIR UNE BOUTEILLE D'UNE PINTe DE NETTOYANT ET LA LAVETTE À TOILETTE



| | | | | | | |
|--------|--|------|-----|---|------|----------|
| WA-220 | Bowl Swab Caddy / Support à lavette et bouteille de toilette | 3.85 | 1.7 | 1 | 10/1 | \$ 12.96 |
|--------|--|------|-----|---|------|----------|

**HD BOWL BRUSH WITH WIRE CENTRE /
BROSSE À CUVETTES RÉsISTANTE AVEC
BROCHE TORSADÉE**



BR-WM214

**HEAVY DUTY PLUNGER /
SIPHON RÉsISTANT**



WA2026

**DELUXE PLUNGER /
SIPHON DELUXE**

- Ergonomically designed handle with a rubber cup that fits most drains and toilets
- Caddy to store plunger
- Manche ergonomique avec un capuchon en caoutchouc qui s'adapte à la plupart des cuvettes
- Porte-siphon



WA2025



| | | | | | | |
|----------|--|-----|-----|---|-------|----------|
| BR-WM214 | HD Bowl Brush with Wire Centre / Brosse à cuvettes résistante avec broche torsadée | | | | 12 | \$ 10.77 |
| WA-2025 | Deluxe Plunger with Plastic Handle / Siphon Deluxe | 6 | 3 | 2 | 32/6 | \$ 11.52 |
| WA-2026 | Heavy Duty Plunger with 16" / 40 cm Wood Handle / Siphon résistant - 16 po / 40 cm | 7.3 | 3.3 | | 48/12 | \$ 7.35 |

URINAL SCREEN / TAMIS D'URINOIR

Wave screens last longer and stop urine splashback eliminating urine on floors /
Tamis désodorisant "wave" durent plus longtemps et empêchent l'éclaboussure et le dépôt de l'urine sur le plancher



| M2 Code Code M2 | Description | Pack Wt LB (S) Poids (lb) (S) | Pack Wt KG Poids (kg) | Cubic Ft Pi3 | Pack Contenu | List Price Liste des prix |
|--------------------|--|----------------------------------|--------------------------|-----------------|-----------------|------------------------------|
| WA-US30 | Wave Urinal Screen – Spiced Apple / Tamis désodorisant "Wave" - Pomme épicée | | | | 12 | \$ 5.59 |
| WA-US31 | Wave Urinal Screen – Fruit Basket / Tamis désodorisant "Wave" - Panier de fruits | | | | 12 | \$ 5.59 |
| WA-US32 | Wave Urinal Screen – Lemon Lime / Tamis désodorisant "Wave" - Citron lime | | | | 12 | \$ 5.59 |
| WA-US33 | Wave Urinal Screen – Ocean Breeze / Tamis désodorisant "Wave" - Brise d'océan | | | | 12 | \$ 5.59 |

URINAL SCREEN / TAMIS D'URINOIR

SCREEN WITH PUCK

- Disposable urinal screen with block
- Long lasting – Cleans and descales with every flush
- Para-Benzene free

TAMIS DÉSORODISANT AVEC BLOC

- Tamis d'urinoir avec bloc jetable
- Longue durée, nettoie et détartre à chaque chasse d'eau
- Sans paradichlorobenzène

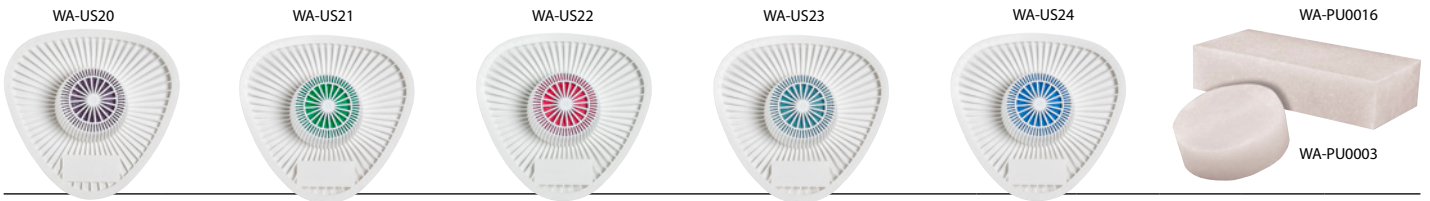

| | | | | | | |
|----------|--|-----|-----|----|--------|----------|
| WA-US19 | Urinal Screen with Puck – Baby Fresh / Tamis désodorisant avec bloc, Bébé frais | 3.7 | 1.7 | .4 | 12 | \$ 4.48 |
| WA-US20 | Urinal Screen with Puck – Lavender / Tamis désodorisant avec bloc, lavande | 3.3 | 1.5 | .3 | 12 | \$ 4.47 |
| WA-US21 | Urinal Screen with Puck – Green Apple / Tamis désodorisant avec bloc, pomme verte | 3.3 | 1.5 | .3 | 12 | \$ 4.47 |
| WA-US22 | Urinal Screen with Puck – Cherry / Tamis désodorisant avec bloc, cerise | 3.3 | 1.5 | .3 | 12 | \$ 4.47 |
| WA-US23 | Urinal Screen with Puck – Pot Pourrie - Teal / Tamis désodorisant avec bloc, pot-pourri - bleu sarcelle | 3.3 | 1.5 | .3 | 12 | \$ 4.47 |
| WA-US24 | Urinal Screen with Puck – Fresh Linen - Blue / Tamis désodorisant avec bloc, linge frais - bleu | 3.3 | 1.5 | .3 | 12 | \$ 4.47 |
| WA-PU003 | 3oz Dichlorobenzene urinal puck, White - Cherry / Tamis désodorisant – dichlorobenzène 3oz - blanc - cerise | | | | 144/12 | \$ 2.57 |
| WA-PU016 | 16oz Dichlorobenzene urinal Block, White - Cherry / Tamis désodorisant – dichlorobenzène 16oz - blanc - cerise | | | | 12 | \$ 16.26 |

FLAT SCREEN DEODORIZERS

- Traditional flat screen helps prevent debris from clogging pipes
- Long lasting fragrance

TAMIS PLÂT DÉSORODISANT

- Tamis plat classique empêchant les débris de boucher les tuyaux
- Parfum longue durée

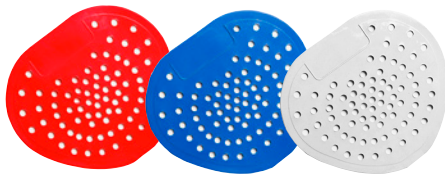

URINAL Z-MAT / TAPIS D'URINOIR Z-MAT

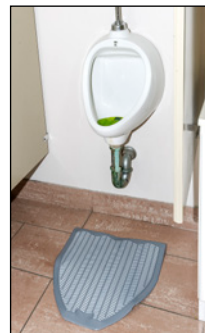
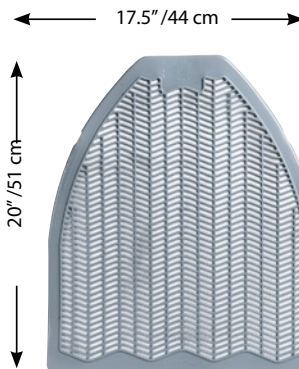

- The Z-Mat gives a Fresh Blast of fragrance to any washroom with urinals.
- It helps protect floors from stains and uric acid damage.
- Le tapis Z-Mat donne une nouvelle rafale de parfum à une salle d'eau avec urinoir
- Il aide à protéger les planchers contre les taches et les dommages de l'acide urique

| M2 Code Code M2 | Description | Pack Wt LB (S) Poids (lb) (S) | Pack Wt KG Poids (kg) | Cubic Ft Pi3 | Pack Contenu | List Price Liste des prix |
|--------------------|---|----------------------------------|--------------------------|-----------------|-----------------|------------------------------|
| WA-US1 | Urinal Screen – Cherry / Tamis désodorisant, cerise | 1.5 | 3.3 | | 12 | \$ 2.33 |
| WA-US2 | Urinal Screen – Bubble Gum / Tamis désodorisant, Bubble gum | 1.5 | 3.3 | | 12 | \$ 2.33 |
| WA-US3 | Urinal Screen – No Scent - White Tamis désodorisant, Pas de parfum Blanc | 1.5 | 3.3 | | 12 | \$ 2.95 |
| ZM-1526 | Z-Mat Toilet Mat / Z-Mat Tapis d'urinoir | | | | 6/1 | \$ 26.87 |



INDOOR/OUTDOOR ACCESSORIES / ACCESSOIRES INTÉRIEURS/EXTÉRIEURS



PAPER DISPENSER / DISTRIBUTEUR DE PAPIER

Universal paper towel dispenser will accept all standard single fold and roll towels (max. 6" diameter and up to 10" long). Front loading for easy service and maintenance. All welded construction of 20 and 22 gauge steel. Full length piano hinge on door.

Le distributeur universel de serviettes de papier acceptera tous les serviettes pliées séparément ou en rouleau (max. 6" diam. et jusqu'à 10" long.). Le remplissage par l'avant facilite le service et la maintenance. Entièrement construit de métal soudé de calibre 20 et 22. Penture de piano pleine longueur sur la porte.

WIDTH INCHES: 10-1/2 (26.67 cm)
DEPTH INCHES: 6-3/4 (17.15 cm)
HEIGHT INCHES: 9-1/2 (24.13 cm)

LARGEUR 10 1/2" (26.67 cm)
PROFONDEUR 6 3/4" (17.15 cm)
HAUTEUR 9 1/2" (24.13 cm)

| M2 Code Code M2 | Description | Pack Wt LB (S) Poids (lb) (S) | Pack Wt KG Poids (kg) | Cubic Ft Pi3 | Pack Contenu | List Price Liste des prix |
|--------------------|---|----------------------------------|--------------------------|-----------------|-----------------|------------------------------|
| WA-P101 | Dual Paper Towel Dispenser / Distributeur De Papier Essuie-Tout | 3.8 | 1.7 | | 6/1 | \$ 54.71 |

TOILET DISPENSERS / DISTRIBUTEUR DE PAPIER HYGIÉNIQUE



Ideal for areas requiring a heavy duty economical dispenser. Tension springs restrict paper consumption to prevent free wheeling of roll. Front loading for easy service and maintenance. All surfaces finished in polished chrome.

Idéal pour les espace qui requiert un distributeur robuste et économique. Un ressort sous tension restreint la consommation du papier pour prévenir le déroulement excessif. Remplissage par l'avant pour faciliter le service et la maintenance. Toutes les surfaces sont finis en chrome poli.

| M2 Code Code M2 | Description | Pack Wt LB (S) Poids (lb) (S) | Pack Wt KG Poids (kg) | Cubic Ft Pi3 | Pack Contenu | List Price Liste des prix |
|--------------------|--|----------------------------------|--------------------------|-----------------|-----------------|------------------------------|
| WA-T146 | Single Roll, Toilet Dispenser / Distributeur de papier hygiénique, Simple | 11.88 | 5.4 | 1.5 | 20/1 | \$ 17.54 |
| WA-T150 | Double Roll, Toilet Dispensere / Distributeur de papier hygiénique, Double | 24.12 | 10.12 | 1.48 | 10/1 | \$ 29.74 |

STAND UP & OUTDOOR ASHTRAYS / CENDRIERS SUR PIED ET D'EXTÉRIEUR



| M2 Code Code M2 | Description | Pack Wt LB (S) Poids (lb) (S) | Pack Wt KG Poids (kg) | Cubic Ft Pi3 | Pack Contenu | List Price Liste des prix |
|--------------------|---|----------------------------------|--------------------------|-----------------|-----------------|------------------------------|
| OD-A909 | Outdoor AshTray - 7.5" x 4.7" x 9.5" / 19 x 12 x 24 cm/ Cendrier extérieur en acier inoxydable - 7.5 x 4.7 x 9.5 po / 19 x 12 x 24 cm | 12.5 | 5.6 | 1.14 | 4/1 | \$ 101.21 |

MICRO WIPING / CHIFFONS - MICROFIBRE



- Blue** – All purpose low risk – used for cleaning common areas, ledges and general cleaning areas
Can also be used for dusting and cleaning windows in lower risk areas
- Green** – Food/Kitchen – used for cleaning in kitchen food prep areas, bars or anywhere food is prepared
- Red** – High risk – used in areas for cleaning toilets and restrooms where there is more risk of infections and cross-contamination
- Yellow** – Medium risk – used for cleaning sinks washbasins, tiles and window ledges

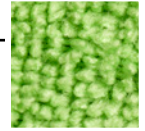

Close-up of MicroCloth fibre
Gros-plan d'un chiffon microfibre

- bleu** - Tout usage à faible risque - pour les aires communes, les rebords des fenêtres et les zones de nettoyage général
Sert également à l'époussetage et au nettoyage des fenêtres dans les aires à faible risque
- vert** – Aliments / cuisine - pour les surfaces de préparation des aliments, les bars
- rouge** – Risque élevé - pour les toilettes, les urinoirs, c'est-à-dire les endroits où les risques d'infection et de contamination croisée sont élevés
- jaune** – Risque moyen - pour les éviers, les carreaux et les rebords des fenêtres

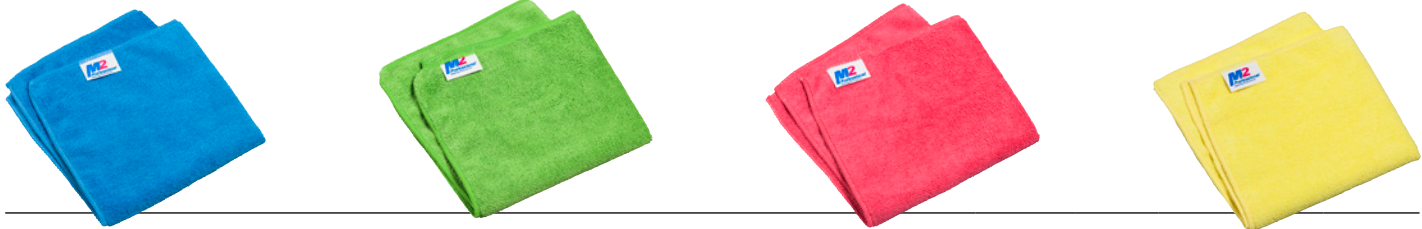

| M2 Code Code M2 | Description | Pack Wt LB (S) Poids (lb) (S) | Pack Wt KG Poids (kg) | Cubic Ft Pi3 | Pack Contenu | List Price Liste des prix |
|---|---|----------------------------------|--------------------------|-----------------|-----------------|------------------------------|
| WOVEN MICROFIBER CLOTH / CHIFFON MICROFIBRE TISSÉ EN VRAC - 300 GSM - 120 Master Case | | | | | | |
| MC-500-BL | Sani-Pro MicroCloth – All Purpose 16"x16"/40 x 40 cm – Blue / Sani-Pro Chiffon microfibre, 16 po x 16 po / 40 x 40 cm, bleu | | | 1.4 | 10 Bag/12 | \$ 3.04 |
| MC-501-GN | Sani-Pro MicroCloth – Food/Kitchen/Common Areas 16"x16"/40 x 40 cm – Green / Sani-Pro Chiffon microfibre, 16 po x 16 po / 40 x 40 cm, verte | | | 1.4 | 10 Bag/12 | \$ 3.04 |
| MC-502-RD | Sani-Pro MicroCloth – Toilets/Bathrooms 16"x16"/40 x 40 cm – Red / Sani-Pro Chiffon microfibre, 16 po x 16 po / 40 x 40 cm, rouge | | | 1.4 | 10 Bag/12 | \$ 3.04 |
| MC-503-YE | Sani-Pro MicroCloth – Bath Tile/Walls 16"x16"/40 x 40 cm – Yellow / Sani-Pro Chiffon microfibre, 16 po x 16 po / 40 x 40 cm, jaune | | | 1.4 | 10 Bag/12 | \$ 3.04 |
| MC-504-OR | Sani-Pro MicroCloth – Bath Tile/Walls 16"x16"/40 x 40 cm –Orange/ Sani-Pro Chiffon microfibre, 16 po x 16 po / 40 x 40 cm, orange | | | 1.4 | 10 Bag/12 | \$ 3.04 |
| 2 PACK - WOVEN MICROFIBER CLOTH / CHIFFON MICROFIBRE TISSÉ EN VRAC - 300 GSM - 120 Master Case | | | | | | |
| MC-520-BL | Sani-Pro MicroCloth – All Purpose 16"x16"/40 x 40 cm – Blue / Sani-Pro Chiffon microfibre, 16 po x 16 po / 40 x 40 cm, bleu | | | 1.4 | 2/Bag | \$ 6.08 |
| MC-521-GN | Sani-Pro MicroCloth – Food/Kitchen/Common Areas 16"x16"/40 x 40 cm – Green / Sani-Pro Chiffon microfibre, 16 po x 16 po / 40 x 40 cm, verte | | | 1.4 | 2/Bag | \$ 6.08 |
| MC-522-RD | Sani-Pro MicroCloth – Toilets/Bathrooms 16"x16"/40 x 40 cm – Red / Sani-Pro Chiffon microfibre, 16 po x 16 po / 40 x 40 cm, rouge | | | 1.4 | 2/Bag | \$ 6.08 |
| MC-523-YE | Sani-Pro MicroCloth – Bath Tile/Walls 16"x16"/40 x 40 cm – Yellow / Sani-Pro Chiffon microfibre, 16 po x 16 po / 40 x 40 cm, jaune | | | 1.4 | 2/Bag | \$ 6.08 |
| ECONOMY WOVEN MICROFIBER CLOTH / CHIFFON MICROFIBRE TISSÉ EN VRAC - 280 GSM - 120 Master Case | | | | | | |
| MC-600-BL | MicroCloth – All Purpose 14"x14"/35 x 35 cm – Blue / Chiffon microfibre, 14"x14"/35 x 35 cm , bleu | | | 1.4 | 12 | \$ 1.65 |
| MC-601-GN | MicroCloth – Food/Kitchen/Common Areas 14"x14"/35 x 35 cm – Green / Chiffon microfibre, 14"x14"/35 x 35 cm , verte | | | 1.4 | 12 | \$ 1.65 |
| MC-602-RD | MicroCloth – Toilets/Bathrooms 14"x14"/35 x 35 cm – Red / Chiffon microfibre, 14"x14"/35 x 35 cm , rouge | | | 1.4 | 12 | \$ 1.65 |
| MC-603-YE | MicroCloth – Bath Tile/Walls 14"x14"/35 x 35 cm – Yellow / Chiffon microfibre, 14"x14"/35 x 35 cm , jaune | | | 1.4 | 12 | \$ 1.65 |
| ECONOMY WOVEN MICROFIBER CLOTH / CHIFFON MICROFIBRE TISSÉ EN VRAC - 280 GSM - 120 Master Case | | | | | | |
| MC-620-BL | MicroCloth – All Purpose 14"x14"/35 x 35 cm – Blue / Chiffon microfibre, 14"x14"/35 x 35 cm , bleu | | | 1.4 | 2/12 | \$ 3.30 |
| MC-621-GN | MicroCloth – Food/Kitchen/Common Areas 14"x14"/35 x 35 cm – Green / Chiffon microfibre, 14"x14"/35 x 35 cm , verte | | | 1.4 | 2/12 | \$ 3.30 |
| MC-622-RD | MicroCloth – Toilets/Bathrooms 14"x14"/35 x 35 cm – Red / Chiffon microfibre, 14"x14"/35 x 35 cm , rouge | | | 1.4 | 2/12 | \$ 3.30 |
| MC-623-YE | MicroCloth – Bath Tile/Walls 14"x14"/35 x 35 cm – Yellow / Chiffon microfibre, 14"x14"/35 x 35 cm , jaune | | | 1.4 | 2/12 | \$ 3.30 |



| | | | | | | |
|--|---|--|--|-----|----|---------|
| WOVEN MICROFIBER CLOTH / CHIFFON MICROFIBRE TISSÉ EN VRAC - 240 GSM - 120 Master Case | | | | | | |
| MC-580-BL | Sani-Pro MicroCloth – All Purpose 16"x16"/40 x 40 cm – Blue / Sani-Pro Chiffon microfibre, 16 po x 16 po / 40 x 40 cm, bleu | | | 1.4 | 12 | \$ 1.47 |
| MC-581-GN | Sani-Pro MicroCloth – Food/Kitchen/Common Areas 16"x16"/40 x 40 cm – Green / Sani-Pro Chiffon microfibre, 16 po x 16 po / 40 x 40 cm, verte | | | 1.4 | 12 | \$ 1.47 |
| MC-582-RD | Sani-Pro MicroCloth – Toilets/Bathrooms 16"x16"/40 x 40 cm – Red / Sani-Pro Chiffon microfibre, 16 po x 16 po / 40 x 40 cm, rouge | | | 1.4 | 12 | \$ 1.47 |
| MC-583-YE | Sani-Pro MicroCloth – Bath Tile/Walls 16"x16"/40 x 40 cm – Yellow / Sani-Pro Chiffon microfibre, 16 po x 16 po / 40 x 40 cm, jaune | | | 1.4 | 12 | \$ 1.47 |
| WINDOW MICROCLOTH / CHIFFON MICROFIBRE POUR VITRES | | | | | | |
| MC-700 | Window MicroCloth 14"x14"/35 x 35 cm / Chiffon microfibre pour vitres, 14 po x 14 po / 35 x 35 cm | | | | 12 | \$ 2.14 |



Q-STAR MICROFIBRE CLOTH / LINGE MICROFIBRE Q-STAR

Features

- Quick and easy handling due to low friction
- Streak free and low linting
- Chemical resistant against disinfectants etc.
- Damp and dry cleaning versatility
- Washable at 95°C / 203°F
- Ideal for computers, hospitals, automotive office and much more

Caractéristiques

- Utilisation facile et rapide grâce à une faible friction
- Pas de traces, peu de peluches
- Résistance chimique aux désinfectants, etc.
- Nettoyage à sec ou humide
- Lavable à 95°C / 203°F
- Idéale pour nettoyer les ordinateurs, les hôpitaux, les voitures, le bureau, etc.



Q-Star cloths can clean all types of surfaces and will clean and pick-up oily type dirt. As a result of the special mfg process the Q-Star cloth is very strong and is tear resistant. Very highly resistant to chemicals with a streak free cleaning

Les chiffons Q-Star peuvent nettoyer tous genres de surfaces et nettoieront et ramasseront la saleté huileuse.

Grâce au processus de fabrication spéciale les tissus Q-Star sont très forts et résistent au déchirement.

Très fortement résistant aux produits chimiques avec un nettoyage sans trainées.



| M2 Code Code M2 | Description | Pack Wt LB (S) Poids (lb) (S) | Pack Wt KG Poids (kg) | Cubic Ft Pi3 | Pack Contenu | List Price Liste des prix |
|---|--|----------------------------------|--------------------------|-----------------|-----------------|------------------------------|
| QM-7580 | Q-Star Microfiber Cloth – 16"x16"/40 x 40 cm - Blue / Linge microfibre Q-Star - 16"x16"/40 x 40 cm - bleu | | | | 12/Bag | \$ 3.56 |
| QM-7581 | Q-Star Microfiber Cloth – 16"x16"/40 x 40 cm - Red / Linge microfibre Q-Star - 16"x16"/40 x 40 cm - rouge | | | | 12/Bag | \$ 3.56 |
| QM-7582 | Q-Star Microfiber Cloth – 16"x16"/40 x 40 cm - Yellow / Linge microfibre Q-Star - 16"x16"/40 x 40 cm - jaune | | | | 12/Bag | \$ 3.56 |
| QM-7583 | Q-Star Microfiber Cloth – 16"x16"/40 x 40 cm - Green / Linge microfibre Q-Star - 16"x16"/40 x 40 cm - vert | | | | 12/Bag | \$ 3.56 |
| Q-STAR MICROFIBRE CLOTH 2 Pack / LINGE MICROFIBRE Q-STAR Paquet de 2 | | | | | | |
| QM-7680 | Q-Star Microfiber Cloth – 16"x16"/40 x 40 cm - Blue - 2 Bag / Linge microfibre Q-Star - 16"x16"/40 x 40 cm - bleu - Paquet de 2 | | | | 2 | \$ 7.12 |
| QM-7681 | Q-Star Microfiber Cloth – 16"x16"/40 x 40 cm - Red - 2 Bag / Linge microfibre Q-Star - 16"x16"/40 x 40 cm - rouge - Paquet de 2 | | | | 2 | \$ 7.12 |
| QM-7682 | Q-Star Microfiber Cloth – 16"x16"/40 x 40 cm - Yellow - 2 Bag / Linge microfibre Q-Star - 16"x16"/40 x 40 cm - jaune - Paquet de 2 | | | | 2 | \$ 7.12 |
| QM-7683 | Q-Star Microfiber Cloth – 16"x16"/40 x 40 cm - Green - 2 Bag / Linge microfibre Q-Star - 16"x16"/40 x 40 cm - vert - Paquet de 2 | | | | 2 | \$ 7.12 |

Q-STAR MICROROLL



FEATURES

- 99.9% Removal of bacteria
- Low linting streak free cleaning



- Disposable microfiber wipe
- High tear resistance
- Damp and dry cleaning versatility
- Ideal for hospitals, foodservice, cleanrooms, computers, office and more

CARACTÉRISTIQUES

- Élimination des bactéries à 99.9%
- Faible peluchage, nettoyage sans trainée
- Lingette microfibre jetable
- Haute résistance à la déchirure
- Polyvalence de nettoyage, humide ou sec
- Idéal pour le nettoyage des hôpitaux, des dépôts alimentaires, des pièces stériles, des ordinateurs, des bureaux et bien plus encore.

DISPOSABLE MICROFIBER WIPES

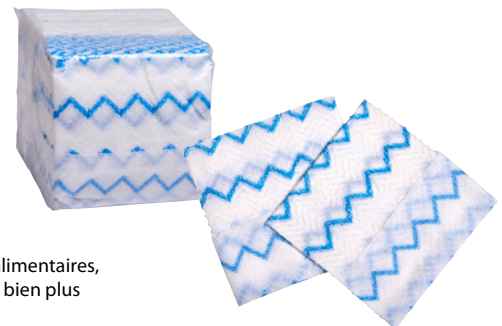

| | | | | | | |
|---------|--|--|--|--|--------|----------|
| QM-8580 | Q-Star Microfiber Roll – White – 13.7x 9.7" / 35 x 25 cm - 110 Sheets per roll / Rouleau microfibre Q-Star - blanc 13.7x 9.7" / 35 x 25 cm - dans 110 feuilles par rouleau | | | | 9/Case | \$ 46.53 |
|---------|--|--|--|--|--------|----------|

| | | | | | | |
|----------|--|--|--|--|--------------------------------------|----------|
| DIS-8113 | Disposable Microfiber wipe-30x30cm/12"x12"-60gsm / | | | | 60/bag/ 12bags/ box= 720 ea | \$ 22.07 |
|----------|--|--|--|--|--------------------------------------|----------|

Swipe Wipes Lingettes



M2 Professional vous apporte une suite de produits-solution pour vos besoins opérationnels du service alimentaire.

Nos produits sont conçus comme des solutions de nettoyage dans la zone de préparation / Cuisine, salle à manger, et installations sanitaires.

Les serviettes de service M2 sont un remplacement de linge de haute qualité offrant une performance exceptionnelle dans divers établissements de restauration.

Les serviettes de service alimentaire M2 peuvent être codées par couleur dans une variété de catégories, et sont disponibles dans des boîtes de distribution.

M2 Professional brings you a suite of product solutions for your foodservice operational needs. Our products are designed as a cleaning solutions in the Prep Area/ Kitchen, Front-of-House/ Dinning, and Facility Areas/Restrooms.

M2 foodservice towels are a high quality linen replacement for outstanding performance in a variety of foodservice establishments.

M2 foodservice towels can be Color Coded in a variety of grades, and are available in dispenser boxes.

Benifits / Avantages:

- Linen Replacement / Remplacement de linge
- Colour Coded System / Système à code couleur
- Reusable / Réutilisable
- Hygienic / Hygiénique
- Washable / Lavable
- Rinsible / Facile à rincer
- Absorbent / Absorbant
- Durable
- Cost Savings / Économie de coûts



| M2 Code Code M2 | Description | Pack Wt LB (S) Poids (lb) (S) | Pack Wt KG Poids (kg) | Cubic Ft Pi3 | Pack Contenu | List Price Liste des prix |
|--|---|----------------------------------|--------------------------|-----------------|-----------------|------------------------------|
| PREMIUM FOODSERVICE WIPE / ESSUIE-TOUT DE QUALITÉ SUPÉRIEURE DE SERVICE ALIMENTAIRE | | | | | | |
| FS-7210-WH | Antimicrobial Foodservice Wipe - 13.25" x 21" / 33.6 x 53.4 cm - White / Lingette antimicrobienne pour service alimentaire - 13.25" x 21" / 33.6 x 53.4 cm - Blanc | 4 lbs | | | 150 Per Case | \$ 87.34 |
| FS-8211-WH | Absorbent Foodservice Wipe- 13.25" x 21" / 33.6 x 53.4 cm - White / Lingette absorbantes de service alimentaire - 13.25" x 21" / 33.6 x 53.4 cm - Blanc | 4 lbs | | | 150 Per Case | \$ 84.75 |
| FS-8211-BL | Absorbent Foodservice Wipe- 13.25" x 21" / 33.6 x 53.4 cm - Blue / Lingettes absorbantes de service alimentaire - 13.25" x 21" / 33.6 x 53.4 cm - Bleu | 4 lbs | | | 150 Per Case | \$ 84.75 |
| FS-8211-RD | Absorbent Foodservice Wipe- 13.25" x 21" / 33.6 x 53.4 cm - Red/Peach / Lingette absorbante de service alimentaire - 13.25" x 21" / 33.6 x 53.4 cm - Rouge/Pêche | 4 lbs | | | 150 Per Case | \$ 84.75 |
| FOODSERVICE WIPE / ESSUIE-TOUT DE SERVICE ALIMENTAIRE | | | | | | |
| FS-6224-RD | Foodservice Wipe - 13.25" x 20" / 33 x 51 cm - Pink / Lingette de service alimentaire - 13.25" x 20" / 33.6 x 51 cm - Rose | 3 lbs | | | 200 Per Case | \$ 65.38 |
| FS-6224-BL | Foodservice Wipe - 13.25" x 20" / 33 x 51 cm - Blue / Lingette de service alimentaire - 13.25" x 20" / 33.6 x 51 cm - Bleu | 3 lbs | | | 200 Per Case | \$ 84.75 |
| FS-6224-GR | Foodservice Wipe - 13.25" x 20" / 33 x 51 cm - Green / Lingette de service alimentaire - 13.25" x 20" / 33.6 x 51 cm - Vert | 3 lbs | | | 200 Per Case | \$ 84.75 |
| FS-1619-WH | Bar Wipe 16 x 19" / 40cm x 48cm - White / Lingette de comptoir 16 x 19 / 40 cm x 48 cm - blanc | | | | 120/12 | \$ 2.88 |

OIL TREATED DUST CLOTH / CHIFFON À POUSSIÈRE TRAITÉ À L'HUILE

M2 Professional Dust Cloths are engineered to deliver quality dust control to help maintain a clean, and healthy work place. M2 Dust Cloths are treated with mineral oil to attract and retain dirt and dust particles without leaving lint or residue. The cloth is a magnet for dust and dirt. It will leave surfaces clean without the use of sprays and their costs associated with the addition of chemicals.

Les chiffons anti-poussières professionnels M2 sont conçus pour offrir un contrôle de la poussière de qualité et maintenir un lieu de travail propre et sain. Les chiffons anti-poussière M2 sont traités avec de l'huile minérale

pour attirer et retenir les particules de saleté et de poussière sans laisser de peluches ou de résidus. Le tissu est un aimant pour la poussière et la saleté. Il va laisser les surfaces propres sans l'utilisation de vaporisateur et leurs coûts associés avec l'ajout de produits chimiques



| M2 Code Code M2 | Description | Pack Wt LB (S) Poids (lb) (S) | Pack Wt KG Poids (kg) | Cubic Ft Pi3 | Pack Contenu | List Price Liste des prix |
|---|---|----------------------------------|--------------------------|-----------------|----------------------|------------------------------|
| OIL TREATED DUSTCLOTH / CHIFFON À POUSSIÈRE TRAITÉ À L'HUILE | | | | | | |
| FS-9224-YE | Oil Treated Dustcloths - 24" x 24" / 61 x 61 cm - Yellow Chiffon à poussière traité à l'huile - 24" x 24" / 61 x 61 cm - Jaune | Average Wt 15 lbs | | | 50 Bags/ Case 500 | \$ 41.85 |



ALL PURPOSE SPONGE CLOTH USED IN A VARIETY OF CLEANING ENVIRONMENTS.

5 Pack
12" x 10" /
31.5 x 25.7 cm

CHIFFON ÉPONGE A TOUT USAGE UTILISÉ DANS UNE VARIÉTÉ DE ENVIRONNEMENTS DE NETTOYAGE.

Rinse the M2 All Purpose Sponge Cloth before the first use and squeeze out all the excess water.

It can be used with the most customary detergents. Do not use detergents with acids or oxidizing agents (e.g. bleach).

To meet the HACCP requirements, please use the our All Purpose Sponge Cloth for one application only..

After usage it can be washed in the washing machine or dishwasher (up to 200°F / 95°C) and you use it again.

The used cloth may be disposed of with the household trash.

Rincez le tissu M2 Chiffon Éponge a Tout Usage avant la première utilisation et essorez tout l'excès d'eau.

Il peut être utilisé avec les détergents les plus courants. Ne pas utiliser de détergents avec des acides ou des agents oxydants (par exemple l'eau de Javel).

Pour répondre aux exigences HACCP, veuillez utiliser notre tissu M2 Chiffon Éponge a Tout Usage pour une seule application. Après utilisation, il peut être lavé dans la machine à laver ou au lave-vaisselle (jusqu'à 200° F / 95° C) et vous l'utilisez à nouveau. Le chiffon utilisé peut être jeté avec les ordures ménagères.

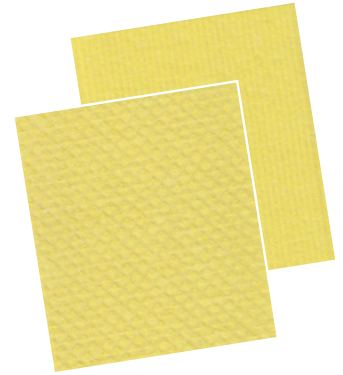
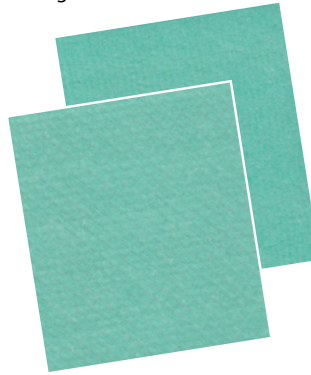
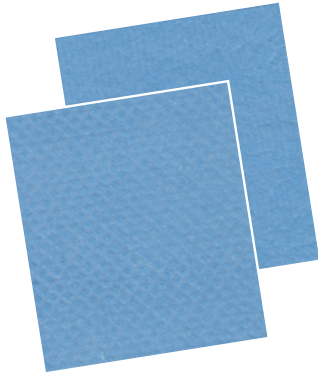

**Industrial Cleaning /
Nettoyage industriel**
OFFICE • HOTELS • SCHOOLS
BUREAU • HÔTELS • ÉCOLES

**Healthcare /
Services sanitaires**
HOSPITALS • RESTROOMS
HÔPITAUX • TOILETTES

**Food Service /
Service alimentaire**
RESTAURANT • FAST FOOD
RESTAURANT • FAST FOOD

**Office & Equipment /
Bureau et équipement**
COMPUTER • ORDINATEURS
TELEVISIONS • TÉLÉVISIONS

Elevators **Ascenseurs**
Windows & Doors **Portes et Fenêtres**
Stairways **Escaliers**
Furniture **Meubles**
Equipment **Équipement**

Washrooms **Toilettes**
Sinks **Éviers**
Tiles **Carrelage**
Technical Equipment **Équipement Technique**
Laundry Rooms **Laverie Chambres**

Glasswear **Verrerie**
Dishes **Vaisselle**
Ovens **Fours**
Tables & Counters **Table et compteurs**
Kitchen Equipment **Equipements de Cuisine**

Computer **Ordinateurs**
Desks **Bureaux**
Electronics **Électronique**
Technical Equipment **Équipement Technique**
Monitors **Moniteurs**

| M2 Code Code M2 | Description | Pack Wt LB (S) Poids (lb) (S) | Pack Wt KG Poids (kg) | Cubic Ft Pi3 | Pack Contenu | List Price Liste des prix |
|--------------------|---|----------------------------------|--------------------------|-----------------|--------------------------|------------------------------|
| SPGC-12101 | SPG All Purpose Cloth – 12"x10"/31.5 x 25.5 cm - Blue / SPG Chiffon a tout usage – 12"x10"/31.5 x 25.5 cm - bleu | | | | 20 Pack 5 Each Bag | \$ 4.43 |
| SPGC-12102 | SPG All Purpose Cloth – 12"x10"/31.5 x 25.5 cm - Red / SPG Chiffon a tout usage – 12"x10"/31.5 x 25.5 cm - rouge | | | | 20 Pack 5 Each Bag | \$ 4.43 |
| SPGC-12103 | SPG All Purpose Cloth – 12"x10"/31.5 x 25.5 cm - Green / SPG Chiffon a tout usage – 12"x10"/31.5 x 25.5 cm - vert | | | | 20 Pack 5 Each Bag | \$ 4.43 |
| SPGC-12104 | SPG All Purpose Cloth – 12"x10"/31.5 x 25.5 cm - Yellow / SPG Chiffon a tout usage – 12"x10"/31.5 x 25.5 cm - jaune | | | | 20 Pack 5 Each Bag | \$ 4.43 |

SILVERCLOTH & NANOSILVER MICROFIBER PADS IDEAL FOR HEALTHCARE & HOSPITAL USE /



CHIFFON EN TISSU D'ARGENT & CHIFFONS EN MICROFIBRE D'ARGENT NANO TECHNOLOGIQUE IDÉAL POUR LES SOINS DE SANTÉ ET HOSPITALIERS



| M2 Code Code M2 | Description | Pack Wt LB (S) Poids (lb) (S) | Pack Wt KG Poids (kg) | Cubic Ft Pi3 | Pack Contenu | List Price Liste des prix |
|--------------------|---|----------------------------------|--------------------------|-----------------|-------------------|------------------------------|
| SLC-13161 | SilverCloth 12"x 15"-30cm X 38 cm – Blue / Chiffon en tissu d'argent 12 po x 15 po / 30 x 38 cm, bleu | | | | 5 Pack 20 Bags | \$ 8.37 |
| SLC-13163 | SilverCloth 12"x 15"-30cm X 38 cm – Green / Chiffon en tissu d'argent 12 po x 15 po / 30 x 38 cm, jaune | | | | 5 Pack 20 Bags | \$ 8.37 |



| M2 Code Code M2 | Description | Pack Wt LB (S) Poids (lb) (S) | Pack Wt KG Poids (kg) | Cubic Ft Pi3 | Pack Contenu | List Price Liste des prix |
|--------------------|---|----------------------------------|--------------------------|-----------------|-----------------|------------------------------|
| MFP-5010-BL | NanoSilver MicroPad 10"/25 cm WetPad -Blue/Blue / Tampon humide microfibre "NanoSilver" bleu/bleu 12"/25 cm | | | | 6 | \$ 18.80 |
| MFP-5012-BL | NanoSilver MicroPad 12"/30 cm WetPad -Blue/Blue / Tampon humide microfibre "NanoSilver" bleu/bleu 12"/30 cm | | | | 6 | \$ 19.98 |
| MFP-5018-BL | NanoSilver MicroPad 18"/45 cm WetPad -Blue/Blue / Tampon humide microfibre "NanoSilver" bleu/bleu 18"/45 cm | | | | 6 | \$ 22.34 |
| MFP-5018-GN | NanoSilver MicroPad 18"/45 cm WetPad -Blue/Green / Tampon humide microfibre "NanoSilver" bleu/vert 18"/45 cm | | | | 6 | \$ 22.34 |
| MFP-5018-RD | NanoSilver MicroPad 18"/45 cm WetPad -Blue/Red / Tampon humide microfibre "NanoSilver" bleu/rouge 18"/45 cm | | | | 6 | \$ 22.34 |
| MFP-6018-GY | NanoSilver MicroScrub 18"/45 cm Wet Pad Non Slip -Blue/Grey/ Tampon humide MicroScrub microfibre "NanoSilver" bleu/gris 18"/45 cm | | | | 6 | \$ 23.87 |



SPONGES & SCOURING & UTILITY PADS / ÉPONGES ET TAMPONS À RÉCURER

SCOURING PADS / TAMPONS À RÉCURER



FOAM SPONGE WITH SCOURING PADS / ÉPONGE EN MOUSSE AVEC TAMPONS À RÉCURER



CELLULOSE SPONGE & SCOURING PADS / ÉPONGE EN CELLULOSE ET TAMPONS À RÉCURER



DRY CLEAN SMOKE SPONGE ÉPONGE POUR NETTOYAGE À SEC



| M2 Code Code M2 | Description | Pack Wt LB (S) Poids (lb) (S) | Pack Wt KG Poids (kg) | Cubic Ft Pi3 | Pack Contenu | List Price Liste des prix |
|--------------------|---|----------------------------------|--------------------------|-----------------|-----------------|------------------------------|
| SP-HSPI | Premium Scouring Pads - Green - 6" x 9" x .3" / 15 x 22 x 7 cm - Case Pack - 10 x 10 / Tampons à récurer de première qualité, vert, 6 po x 9 po x 0,3 po / 15 x 22 x 7 cm, Lot, 10 x 10 | 4.4 | 2 | 1.4 | 100/10 | \$ 1.43 |
| SP-HSPB | Ecoline Scouring Pads - Green - 6" x 9" x .3" / 15 x 22 x 7 cm - Case Pack - 100 / Tampons à récurer Ecoline, vert, 6 po x 9 po x 0,3 po / 15 x 22 x 7 cm, Lot, 100 | 4.4 | 2 | 1.4 | 100 | \$ 1.22 |
| SP-SSS | Foam Sponge with Scouring Pads - 4" x 6" x 1" / 10 x 15 x 2.5 cm - Case Pack - 5 x 10 / Éponge en mousse avec tampons à récurer, 4 po x 6 po x 1 po / 10 x 15 x 2.5 cm, Lot, 5 x 10 | 6.1 | 2.8 | 1.4 | 50/5 | \$ 1.55 |
| SP-E747 | Cellulose Sponge with Scouring Pads - 4" x 6" x .875" / 10 x 15 x 2 cm - Case Pack - 1 x 50 - Green / Éponge en cellulose avec tampons à récurer, 4 po x 6 po x 0,875 po / 10 x 15 x 2 cm, Lot, 1 x 50 - vert | 6.1 | 2.8 | .8 | 50/10 | \$ 3.29 |
| SP-E749 | Cellulose Sponge with Scouring Pads - 4" x 6" x .875" / 10 x 15 x 2 cm - Case Pack - 1 x 50 - White / Éponge en cellulose avec tampons à récurer, 4 po x 6 po x 0,875 po / 10 x 15 x 2 cm, Lot, 1 x 50 - blanc | 6.1 | 2.8 | .8 | 50/10 | \$ 2.83 |
| SP-SM115 | Dry Cleaning Smoke Sponge 1-1/2" x 3" x 6", Individually Wrapped, 36 Per Case Éponge pour nettoyage à sec 1 1/2" x 3" x 6", enveloppée individuellement, 36 par caisse | | | | 36/1 | \$ 13.17 |

ERASER SPONGE ÉPONGE MAGIQUE

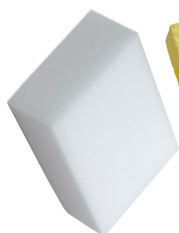

CELLULOSE SPONGE ÉPONGE EN CELLULOSE



GROUT / ÉPONGE À COULIS



UTILITY PADS - LIGHT / TAMPONS À RÉCURER POUR TRAVAUX LÉGERS



UTILITY PADS - COURSE / TAMPONS À RÉCURER POUR GROS TRAVAUX



STAINLESS STEEL SCOUR PUFF HOUPPETTE À RÉCURER EN ACIER INOXYDABLE



Refer to Page --- for Doodle Bug Frame / Se référer à la page --- pour les cadres "Doodle Bug"

ERASER SPONGE / ÉPONGE MAGIQUE

| | | | | | | |
|----------|--|-----|-----|------|-------|---------|
| SP-ER900 | Eraser Sponge - 4.5" x 6" x 2.25 x 1" / 12 x 6 cm 3,5 cm - Case Pack - 12 x 12 = 144 / Éponge magique, 4,5 po x 6 po x 2,25 x 1 po / 12 x 6 cm 3,5 cm, Lot, 12 x 12 = 144 | 6.1 | 2.8 | 1.8 | 12 | \$ 1.50 |
| SP-ER901 | Eraser Sponge - 4.5" x 6" x 2.25 x 1" / 12 x 6 cm 3,5 cm - Case Pack - 12 x 12 = 144 / Éponge magique, 4,5 po x 6 po x 2,25 x 1 po / 12 x 6 cm 3,5 cm, Lot, 12 x 12 = 144 | 6.1 | 2.8 | 1.8 | 12 | \$ 1.77 |
| SP-ER902 | Eraser Sponge - 4.5" x 6" x 2.25 x 1" / 12 x 6 cm 3,5 cm - Retail Pack - 2 ea Éponge magique, 4,5 po x 6 po x 2,25 x 1 po / 12 x 6 cm 3,5 cm, | | | | 2 | \$ 3.35 |
| SP-E745 | Cellulose Sponge Only - 4" x 6" x 1.75" / 10 x 15 x 4.5 cm - Case Pack - 1 x 50 / Éponge en cellulose seulement, 4 po x 6 po x 1,75 po / 10 x 15 x 4,5 cm, Lot, 1 x 50 | 6.1 | 2.8 | 1.8 | 50/10 | \$ 5.04 |
| SP-E800 | Grouting Sponge / Sharp Edge & Round edge - 7" x 5" x 2" / 18 x 13 x 5 cm - Case Pack / Éponge à coulis / rebord en angle et rebord arrondi, 7 po x 5 po x 2 po / 18 x 13 x 5 cm, Lot | 6.1 | 2.8 | 1.83 | 12/1 | \$ 5.78 |

UTILITY PADS / TAMPONS À RÉCURER

| | | | | | | |
|----------|--|-----|----|----|----|---------|
| SP-UT-WH | White Utility Pads - Light - 9.875" x 4.625" x .9" / 25 x 12 x 22 cm Tampons à récurer blancs pour travaux légers, 9,875 po x 4,625 po x 0,9 po / 25 x 12 x 22 cm | 1.1 | .5 | .7 | 20 | \$ 3.91 |
| SP-UT-BK | Black Utility Pad - Course - 9.875" x 4.625" x .9" 25 x 12 x 22 cm Tampons à récurer noirs pour gros travaux, 9,875 po x 4,625 po x 0,9 po 25 x 12 x 22 cm | 1.1 | .5 | .7 | 20 | \$ 3.91 |
| SP-UT-BL | Blue Utility Pads - Light - 9.875" x 4.625" x .9" / 25 x 12 x 22 cm Tampons à récurer bleus pour travaux légers, 9,875 po x 4,625 po x 0,9 po / 25 x 12 x 22 cm | 1.1 | .5 | .7 | 20 | \$ 3.91 |
| SP-UT-BN | Brown Utility Pad - Course - 9.875" x 4.625" x .9" 25 x 12 x 22 cm Tampons à récurer brun pour gros travaux, 9,875 po x 4,625 po x 0,9 po 25 x 12 x 22 cm | 1.1 | .5 | .7 | 20 | \$ 3.91 |
| SP-SS-50 | 50G Stainless Steel Scour Puff - Sleeves of 12 - Case Pack 144 (12 x 12) / 50G Houppette à récurer en acier inoxydable - paquet de 144 (caisse 12x12) | | | | 12 | \$ 3.44 |

WINDOW CLEANING / NETTOYAGE DES VITRES



WINDOW CLEANING / NETTOYAGE DES VITRES

BRASS HANDLE / POIGNÉE EN LAITON



SWIVEL HANDLE / MANCHE PIVOTANT



BRASS CHANNEL WITH RUBBER /
LAME DE LAITON AVEC CAOUTCHOUC



For Use With
FH-360-1T Handle
À Utiliser Avec Le
Manche FH-360-1T

| M2 Code Code M2 | Description | Pack Wt LB (S) Poids (lb) (S) | Pack Wt KG Poids (kg) | Cubic Ft Pi3 | Pack Contenu | List Price Liste des prix |
|---|--|----------------------------------|--------------------------|-----------------|-----------------|------------------------------|
| WS-BR00 | Brass window squeegee handle / Poignée de raclette à vitres en laiton | 3.00 | 1.36 | .15 | 10 | \$ 18.11 |
| WS-SW00 | Swivel squeegee handle - For Brass Channels / Poignée pivotante à raclette pour lame en laiton | | | | 10 | \$ 27.93 |
| BRASS CHANNEL WITH RUBBER / LAME DE LAITON AVEC CAOUTCHOUC | | | | | | |
| WS-BR12 | 12" / 30 cm Channel with rubber - Brass / Lame de laiton avec caoutchouc, 12 po / 30 cm | 12.80 | 5.81 | .0002 | 10 | \$ 13.11 |
| WS-BR14 | 14" / 35 cm Channel with rubber - Brass / Lame de laiton avec caoutchouc, 14 po / 35 cm | 14.75 | 6.69 | .0002 | 10 | \$ 14.49 |
| WS-BR18 | 18" / 45 cm Channel with rubber - Brass / Lame de laiton avec caoutchouc, 18 po / 40 cm | 18.70 | 8.48 | .0002 | 10 | \$ 17.28 |
| WS-BR22 | 22" / 55 cm Channel with rubber - Brass / Lame de laiton avec caoutchouc, 22 po / 55 cm | 19.70 | 8.48 | .0002 | 10 | \$ 24.29 |

STAINLESS STEEL HANDLE /
POIGNÉE EN ACIER INOXYDABLE



PREMIUM SQUEEGEE QUICK CHANGE HANDLE /
POIGNÉE DE RACLETTE À CHANGEMENT RAPIDE - PREMIUM



STAINLESS STEEL CHANNEL WITH RUBBER /
LAME EN ACIER INOXYDABLE AVEC CAOUTCHOUC



| M2 Code Code M2 | Description | Pack Wt LB (S) Poids (lb) (S) | Pack Wt KG Poids (kg) | Cubic Ft Pi3 | Pack Contenu | List Price Liste des prix |
|---|---|----------------------------------|--------------------------|-----------------|-----------------|------------------------------|
| WS-SS00 | Stainless steel squeegee handle / Poignée de raclette à vitres en acier inoxydable | 3.20 | 1.45 | .15 | 10 | \$ 14.10 |
| WS-P00 | Premium Squeegee Handle-Quick Change / Poignée de raclette à changement rapide - Premium | 3.2 | 1.5 | | 10 | \$ 22.69 |
| STAINLESS STEEL CHANNEL WITH RUBBER / LAME EN ACIER INOXYDABLE AVEC CAOUTCHOUC | | | | | | |
| WS-SS12 | 12" / 30 cm Channel with rubber - Stainless Steel / Lame en acier inoxydable avec caoutchouc, 12 po / 30 cm | 12.80 | 5.81 | .0002 | 10 | \$ 9.00 |
| WS-SS14 | 14" / 35 cm Channel with rubber - Stainless Steel / Lame en acier inoxydable avec caoutchouc, 14 po / 35 cm | 14.75 | 6.69 | .0002 | 10 | \$ 9.83 |
| WS-SS18 | 18" / 40 cm Channel with rubber - Stainless Steel / Lame en acier inoxydable avec caoutchouc, 18 po / 40 cm | 18.70 | 8.48 | .0002 | 10 | \$ 11.37 |
| WS-SS22 | 22" / 55 cm Channel with rubber - Stainless Steel / Lame en acier inoxydable avec caoutchouc, 22 po / 55 cm | 19.70 | 8.48 | .0002 | 10 | \$ 15.02 |

RUBBER REFILLS & BRASS CLIP / CAOUTCHOUC DE RECHANGE ET ATTACHE EN LAITON

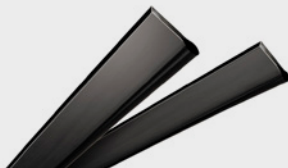

| M2 Code Code M2 | Description | Pack Wt LB (S) Poids (lb) (S) | Pack Wt KG Poids (kg) | Cubic Ft Pi3 | Pack Contenu | List Price Liste des prix |
|--|--|----------------------------------|--------------------------|-----------------|-----------------|------------------------------|
| REPLACEMENT RUBBER / CAOUTCHOUC DE RECHANGE | | | | | | |
| WS-RU12 | 12" / 30 cm Replacement rubber / Caoutchouc de rechange, 12 po / 30 cm | .50 | .23 | .12 | 10 | \$ 3.15 |
| WS-RU14 | 14" / 35 cm Replacement rubber / Caoutchouc de rechange, 14 po / 35 cm | .55 | .25 | .14 | 10 | \$ 3.48 |
| WS-RU18 | 18" / 40 cm Replacement rubber / Caoutchouc de rechange, 18 po / 40 cm | .70 | .32 | .18 | 10 | \$ 4.38 |
| WS-RU22 | 22" / 55 cm Replacement rubber / Caoutchouc de rechange, 22 po / 55 cm | | | | 10 | \$ 6.21 |
| WS-RU42 | 42" / 106 cm Replacement rubber / Caoutchouc de rechange, 42 po / 106 cm | | | | 10 | \$ 17.08 |
| WS-BR01 | Clip for brass window squeegee // Attache en laiton pour raclette à vitres | .1 | .05 | .01 | 10 | \$.91 |

WINDOW SQUEEGEE



| M2 Code Code M2 | Description | Pack Wt LB (S) Poids (lb) (S) | Pack Wt KG Poids (kg) | Cubic Ft Pi3 | Pack Contenu | List Price Liste des prix |
|--------------------|--|----------------------------------|--------------------------|-----------------|-----------------|------------------------------|
| FS-MP10-WH | 10" Moss Counter Squeegee with Natural Rubber - White, Blue, Red, Yellow Green | | | | 10/1 | \$ 48.84 |

PLASTIC SQUEEGEE COMPLETE \ RACLETTE EN PLASTIQUE COMPLÈTE



| | | | | | | |
|---------|--|-----|-----|--|----|----------|
| WS-PL12 | 12"/ 30 cm Plastic window squeegee complete / 12"/ 30 cm Raclette à vitres en plastique complète | 2.2 | 1.0 | | 10 | \$ 15.09 |
| WS-PL18 | 18"/45 cm Plastic window squeegee complete / 18"/45 cm Raclette à vitres en plastique complète | 2.8 | 1.3 | | 10 | \$ 18.32 |

T-BAR HANDLE / SUPPORT EN T



| M2 Code Code M2 | Description | Pack Wt LB (S) Poids (lb) (S) | Pack Wt KG Poids (kg) | Cubic Ft Pi3 | Pack Contenu | List Price Liste des prix |
|--|---|----------------------------------|--------------------------|-----------------|-----------------|------------------------------|
| T-BAR HANDLE / SUPPORT EN T | | | | | | |
| WS-TB10 | 10"/25 cm T- Bar Handle / Support en T, 10 po/25 cm | 3.0 | 1.36 | .49 | 10 | \$ 9.18 |
| WS-TB14 | 14"/35 cm T- Bar Handle / Support en T, 14 po/35 cm | 3.6 | 1.63 | .66 | 10 | \$ 10.55 |
| WS-TB18 | 18"/45 cm T- Bar Handle / Support en T, 18 po/45 cm | 4.35 | 1.97 | .84 | 10 | \$ 11.74 |
| T-BAR SWIVEL HANDLE / MANCHE RACLETTE VITRES PIVOTANT | | | | | | |
| WS-TBS10 | 10"/25 cm T- Bar Swivel Handle / Manche Raclette Vitres pivotant, 10 po/25 cm | | | | 10 | \$ 20.32 |
| WS-TBS14 | 14"/35 cm T- Bar Swivel Handle / Manche Raclette Vitres pivotant,, 14 po/35 cm | | | | 10 | \$ 23.18 |
| WS-TBS18 | 18"/45 cm T- Bar Swivel Handle / Manche Raclette Vitres pivotant,, 18 po/45 cm | | | | 10 | \$ 25.68 |
| WS-TBS22 | 22"/55 cm ALUMINUM T- Bar Swivel Handle / Manche Raclette Vitres pivotant – ALUMINUM , 22 po/55 cm | | | | 10 | \$ 33.56 |
| PREMIUM T-BAR HANDLE / | | | | | | |
| WS-TBP10 | 10"/25 cm Premium T- Bar Handle / Support en T, 10"/25 cm - Premium T | 3 | 1.4 | | 10 | \$ 11.94 |
| WS-TBP14 | 14"/35 cm Premium T- Bar Handle / Support en T 14"/35 cm - Premium T | 3.6 | 1.6 | | 10 | \$ 13.21 |
| WS-TBP18 | 18"/45 cm Premium T- Bar Handle / Support en T 18"/45 cm - Premium T | 4.3 | 2 | | 10 | \$ 14.48 |
| WS-AC007 | Click & Scrub Pad, Clicks on to T-Bar 10 Pcs/Bag - 10 Bags/Box / Tampon "Click & Scrub" s'attache au support en T 10 pcs/sac - 10 sacs/bte | | | | 10 | \$ 3.05 |

WINDOW BUCKET / SEAU À VITRES



- High impact buckets with waxing sieve
- Strong durable handle for easy carrying
- Wheels for easy maneuverability

- Seau très résistant avec tamis pour appliquer la cire
- Transport facile grâce à l'anse robuste et durable
- Roulettes pour une grande maniabilité



| M2 Code Code M2 | Description | Pack Wt LB (S) Poids (lb) (S) | Pack Wt KG Poids (kg) | Cubic Ft Pi3 | Pack Contenu | List Price Liste des prix |
|--------------------|---|----------------------------------|--------------------------|-----------------|-----------------|------------------------------|
| PA-W1120 | Window Bucket with Caddy and Wheels – Yellow / Seau à vitres, jaune | 26.5 | 12 | 3.7 | 5/1 | \$ 45.37 |



| | | | | | | |
|-----------------|---|--|--|--|------|----------|
| EFM-PS-10100-BL | Window Bucket - Blue / Seau à vitres - bleu | | | | 10/1 | \$ 53.80 |
| EFM-PS-10101-BL | Window Bucket Lid - Blue / Couvercle pour seau à vitres - bleu | | | | 1 | \$ 28.74 |
| EFM-PS-10102-RD | Window Bucket - Red / Seau à vitres - rouge | | | | 10/1 | \$ 47.92 |
| EFM-PS-10103-RD | Window Bucket Lid - Red / Couvercle pour seau à vitres - rouge | | | | 1 | \$ 28.74 |
| EFM-PS-10104 | Presoak Bucket Wheels Only (Set of 4) / Roues pour seau de pré-trempage seulement (pq de 4) | | | | 1 | \$ 32.06 |

MICROFIBER WASHING SLEEVE / RECHANGES POUR LAVETTES À VITRES MICROFIBRE



| ECONOMY WASHING SLEEVE / RECHANGE POUR LAVETTE ÉCONOMIQUE | | | | | | |
|---|-----------|---|------|-----|-----|-------------|
| WS-WS10 | 10"/25 cm | Washing sleeve refill / Rechange pour lavette à vitres, 10 po/25 cm | 1.05 | .48 | .20 | 10 \$ 11.59 |
| WS-WS14 | 14"/35 cm | Washing sleeve refill / Rechange pour lavette à vitres, 14 po/35 cm | 1.40 | .64 | .29 | 10 \$ 13.83 |
| WS-WS18 | 18"/45 cm | Washing sleeve refill / Rechange pour lavette à vitres, 18 po/45 cm | 1.70 | .77 | .37 | 10 \$ 16.08 |
| WS-WS22 | 22"/55 cm | Washing sleeve refill / Rechange pour lavette à vitres, 22 po/55 cm | | | | 10 \$ 33.78 |
| WASHING SLEEVE REFILL WITH ABRASIVE STRIP / RECHANGE POUR LAVETTE AVEC BANDE ABRASIVE | | | | | | |
| WS-WSAB14 | 14"/35 cm | Washing sleeve refill with abrasive strip / Rechange pour lavette avec bande abrasive, 14 po/35 cm | | | | 10 \$ 23.45 |
| WS-WSAB18 | 18"/45 cm | Washing sleeve refill with abrasive strip / Rechange pour lavette avec bande abrasive,, 18 po/45 cm | | | | 10 \$ 26.74 |
| STANDARD MICROFIBER WASHING SLEEVE / RECHANGE DE LAVETTE MICROFIBRE STANDARD | | | | | | |
| WS-WSEM10 | 10"/25 cm | Microfiber washing sleeve refill / Rechange pour lavette à vitres, 14 po/35 cm | 1.40 | .64 | .29 | 10 \$ 20.89 |
| WS-WSEM14 | 14"/35 cm | Microfiber washing sleeve refill / Rechange pour lavette à vitres, 14 po/35 cm | 1.40 | .64 | .29 | 10 \$ 24.24 |
| WS-WSEM18 | 18"/45 cm | Microfiber washing sleeve refill / Rechange pour lavette à vitres, 18 po/45 cm | 1.70 | .77 | .37 | 10 \$ 29.08 |

ACCESSORIES

TOOL HOLDER / PORTE-OUTILS

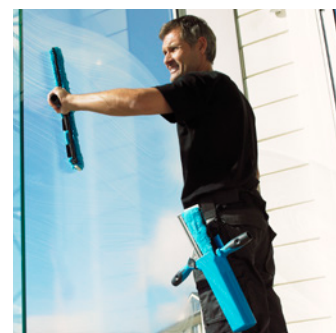

| M2 Code Code M2 | Description | Pack Wt LB (S) Poids (lb) (S) | Pack Wt KG Poids (kg) | Cubic Ft Pi3 | Pack Contenu | List Price Liste des prix |
|--------------------|---|----------------------------------|--------------------------|-----------------|-----------------|------------------------------|
| WS-AC003 | Tool Holder / Porte-outils | 4.6 | 2.0 | | 5/1 | \$ 46.68 |
| WS-AC004 | Tool Holder Belt / Ceinture de porte-outils | 2.2 | 1.0 | | 5/1 | \$ 36.06 |

CAR SQUEEGEE / RACLETTE D'AUTOMOBILE

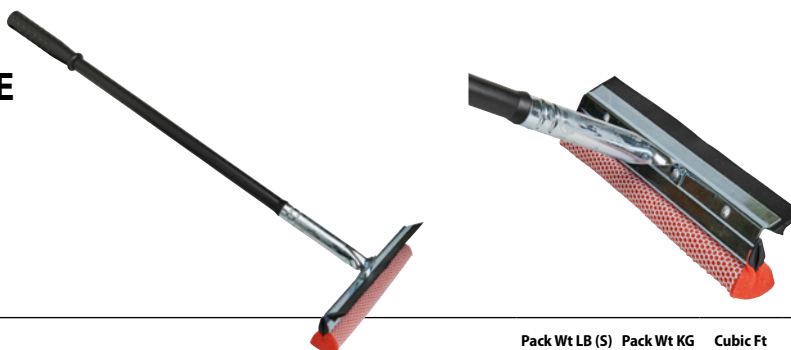

| M2 Code Code M2 | Description | Pack Wt LB (S) Poids (lb) (S) | Pack Wt KG Poids (kg) | Cubic Ft Pi3 | Pack Contenu | List Price Liste des prix |
|--------------------|---|----------------------------------|--------------------------|-----------------|-----------------|------------------------------|
| WS-CS1021-P | 10" Car squeegee with 24" Heavy Duty Plastid Handle / | | | | 12 | \$ 9.75 |

CLEANO STATE OF ART IN INDOOR WINDOW CLEANING AND OTHER WASHABLE SURFACES / LE SUMMON DANS LE NETTOYAGE DES VITRES INTÉRIEURES ET AUTRES SURFACES LAVABLES



BALL VALVE

The use of a ball valve provides added benefits for the user:

- The refill can be applied at any angle.

RÉSERVOIR OVAL

L'utilisation d'un réservoir oval ajoute des bénéfices pour l'utilisateur:

- Le remplissage peut se faire dans n'importe quel angle



NO-TWIST MECHANISM

- The mechanical pump is operated by hand.

MÉCANISME ANTI-TORSION

- La pompe mécanique est actionnée à la main.

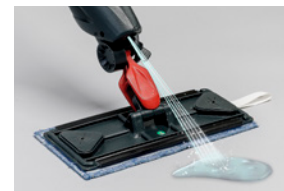

MICRO-SPRAY

Optimal distribution of the right amount of pure water on the surface

MICRO-PULVÉRISATION

Une répartition optimale de la bonne quantité d'eau pure sur la surface

**CLEANS GLASS FAST...
IN ONE PASS!
NETTOIE LES VITRES
RAPIDEMENT EN
UN PASSAGE SEULEMENT**

**CAN ALSO BE
USED DRY!
PEUT AUSSI ÊTRE
UTILISÉ À SEC**

CLEANOPAD

- Launderable pads
- Microfibre pad for window cleaning.
- Seamless microfibre, no streaks, no smudges.
- Slides smoothly, degreases, absorbs.
- Cleans without detergent.

TAMPON CLEANO

- Tampons lavable
- Tampon en microfibre pour le nettoyage des fenêtres
- Microfibre sans couture, sans stries, sans bavures
- Glisse en douceur, dégraisse, absorbe
- Nettoie sans détergent

| | | | | | | |
|-------------|--|--|--|--|---|----------|
| WS-CL-15060 | Cleano Telescopic combo tool-3 microfibre pads included for indoor window cleaning / Outil télescopique pour le nettoyage des vitres JR intérieures avec 3 mouilleurs en microfibre | | | | 1 | \$656.02 |
| WS-CL-15061 | Cleano Microfibre Glass Mop Pad - Blue Only window cleaning Mouilleur microfibre nettoyage de vitres | | | | 5 | \$ 22.61 |



EXTENSION HANDLES / MANCHES EXTENSIBLES

EXTENSION HANDLES – 2 PIECE /
MANCHES EXTENSIBLES EN 2 PARTIES

TELESCOPIC POLE HOLDER BASE /
SUPPORT DE PERCHE TÉLESCOPIQUE

TELESCOPIC POLE THREAD ADAPTER /
ADAPTATEUR FILETÉ DE PERCHE TÉLESCOPIQUE



| M2 Code Code M2 | Description | Pack Wt LB (S) Poids (lb) (S) | Pack Wt KG Poids (kg) | Cubic Ft Pi3 | Pack Contenu | List Price Liste des prix |
|---|---|----------------------------------|--------------------------|-----------------|-----------------|------------------------------|
| 2 PIECE EXTENSION HANDLE / MANCHES EXTENSIBLES EN 2 PARTIES | | | | | | |
| WS-TP08-2 | 8' Telescopic pole in 2 pieces – 8 ft/2.4m / Perche télescopique en 2 parties, 8 pi / 2,4m | 9.5 | 4.3 | 1.1 | 5/1 | \$ 52.38 |
| WS-TP12-2 | 12' Telescopic pole in 2 pieces – 12 ft/3.6m / Perche télescopique en 2 parties, 12 pi / 3,6m | 15.4 | 6.9 | 1.6 | 5/1 | \$ 58.48 |
| 3 PIECE EXTENSION HANDLE / MANCHES EXTENSIBLES EN 3 PARTIES | | | | | | |
| WS-TP09-3 | 9' Telescopic pole in 3 pieces – 9.8 ft/3m / Perche télescopique en 3 parties, 9,8 pi / 3m | 10 | 4.5 | .63 | 5/1 | \$ 73.48 |
| WS-TP16-3 | 16' Telescopic pole in 3 pieces – 16,4 ft/5m / Perche télescopique en 3 parties, 16,4 pi / 5m | | | | 5/1 | \$ 124.01 |
| 4 PIECE EXTENSION HANDLE / MANCHES EXTENSIBLES EN 4 PARTIES | | | | | | |
| WS-TP16-4-M | 16' Telescopic pole in 4 pieces – 16.4 ft/5m / Perche télescopique en 4 parties, 16,4 pi / 5m | 15.8 | 7.1 | .90 | 5/1 | \$ 119.24 |
| WS-TP20-4-M | 20' Telescopic pole in 4 pieces – 20 ft / 6m / Perche télescopique en 4 parties, 20 pi / 6m | | | | 5/1 | \$ 179.62 |
| WS-TP20-3 | 20' Telescopic pole in 3 pieces – 20 ft / 6m / Perche télescopique en 4 parties, 20 pi / 6m | | | | 5/1 | \$ 179.62 |
| WS-TP30-3 | 30' Telescopic pole in 3 pieces – 30ft x 9 m / 30' Perche télescopique en 3 pièces - 30'/9m | | | | 5/1 | \$ 283.09 |
| TELESCOPIC POLE HOLDER BASE / SUPPORT DE PERCHE TÉLESCOPIQUE | | | | | | |
| CC-90010 | Telescopic pole holder base / Support de erche télescopique | | | | 1 | \$ 264.25 |
| TELESCOPIC POLE ADAPTER | | | | | | |
| WS-TP100-P | Threaded cone adapter / Adaptateur conique fileté | .7 | .35 | .10 | 10/1 | \$ 7.49 |
| WS-TP100-M | Threaded cone adapter / Adaptateur conique fileté | .7 | .35 | .10 | 10/1 | \$ 7.49 |
| WS-TP102 | Cone and Clamp for 2 Piece Telescopic Pole – 1 Small Set / Nécessaire cône de sécurité et pince de fixation pour perche télescopique en 2 parties, 1 petit ensemble | .7 | .35 | .10 | 5/1 | \$ 11.64 |
| WS-TP103 | Cone and Clamp for 3 Piece Telescopic Pole – 1 Medium Set / Nécessaire cône de sécurité et pince de fixation pour perche télescopique en 3 parties, 1 moyen ensemble | .7 | .35 | .10 | 5/1 | \$ 12.53 |
| WS-TP104 | Cone and Clamp for 3 Piece Telescopic Pole – 1 Large Set / Nécessaire cône de sécurité et pince de fixation pour perche télescopique en 3 parties, 1 grande ensemble | .7 | .35 | .10 | 5/1 | \$ 13.35 |

FLEX SAFETY WINDOW SCRAPER / GRATTOIR À VITRES DE SÉCURITÉ FLEX



WS-SC1

WS-SC205

WS-SC2-2



WS-SCR003

| | | | | | | |
|-----------|--|-----|-----|--|------|----------|
| WS-SC1 | 1 1/2" / 3.8 cm Flex Safety Scraper / Grattoir de sécurité Flex, 1 1/2 po / 3.8 cm | 2.8 | 1.3 | | 20/1 | \$ 8.23 |
| WS-SC205 | 1 1/2" Economy Safety Scraper / | | | | | \$ 7.31 |
| WS-SC2 | 10cm Scraper with 10 Blades in Plastic Case / Grattoir 10 cm avec 10 lames dans un coffret en plastique | 1 | .4 | | 10/1 | \$ 13.28 |
| WS-SC2-1 | 10cm Scraper Holder Only | 1 | .4 | | 10/1 | \$ 10.33 |
| WS-SC2-2 | 10cm Scraper Blades Only - 10 Blade/Pack | 1 | .4 | | 10/1 | \$ 13.60 |
| WS-SCR003 | Flex Scraper Blades – 1 1/2" – Refill Blades (100 Blades) / Lames de rechange (100) pour grattoir Flex, 1 1/2 po | 1 | .4 | | 100 | \$.54 |

WINDOW & FLOOR SCRAPERS / FENÊTRE ET ÉTAGE RACLEUR

4" FLEX SCRAPER & COMFORT GRIP
GRATTOIR FLEX DE 4 PO DE LARGEUR
AVEC POIGNÉE ERGONOMIQUE

4" FLEX SCRAPER WITH 12" HANDLE
GRATTOIR FLEX DE 4 PO
DE LARGEUR, MANCHE DE 12 PO

4" FLEX SCRAPER WITH 48" HANDLE
GRATTOIR FLEX DE 4 PO
DE LARGEUR, MANCHE DE 48 PO

WS-SC4

WS-SC12

WS-SC48-M

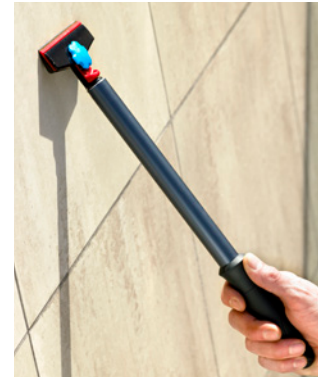

WS-SCR001

WS-SCR002

4" FLEX FLOOR SCRAPER BLADES - .2 MM
LAMES DE GRATTOIR FLEX POUR PLANCHER DE
4 PO DE LARGEUR, 0,2 MM

| M2 Code Code M2 | Description | Pack Wt LB (S) Poids (lb) (S) | Pack Wt KG Poids (kg) | Cubic Ft Pi3 | Pack Contenu | List Price Liste des prix |
|--------------------|--|----------------------------------|--------------------------|-----------------|-----------------|------------------------------|
| WS-SC4 | 4" / 10 cm Wide Flex Scraper with Comfort Grip / Grattoir Flex de 4 po/ 10 cm de largeur avec poignée ergonomique | 5 | 2.2 | .33 | 10 | \$ 24.20 |
| WS-SC12 | 4" / 10 cm Wide FlexScraper with 12"/30 cm Handle / Grattoir Flex de 4 po/ 10 cm de largeur, manche de 12 po/30 cm | 5.1 | 2.3 | .34 | 5 | \$ 28.19 |
| WS-SC48-M | 4" / 10 cm Wide Flex Scraper with 48"/121 cm Handle / Grattoir Flex de 4 po/ 10 cm de largeur, manche de 48 po/121 cm | 10.35 | 4.6 | 1.5 | 5 | \$ 42.19 |
| WS-SCR001 | 4" / 10 cm Flex Razor Blades – 4" x .2 mm – (25 Blades/Dispenser) / Lames de rasoir Flex de 4 po de largeur, 4 po x 0,2mm (étui de 25 lames) | 2.5 | 1.1 | .74 | 25 | \$ 1.07 |
| WS-SCR002 | 4" / 10 cm Flex Scraper Blades – 4" x .4 mm – (25 Blades) / Lames de grattoir Flex de 4 po de largeur, 4 po x 0,4mm (25 Lames) | 2.5 | 1.1 | .68 | 25 | \$ 1.25 |

WS-SR01510

WS-SR01530

WS-SR01640

WS-SC48

WS-SCR56

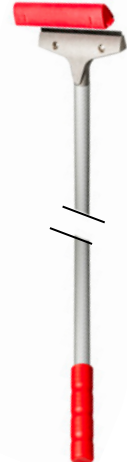

WS-SCR1641



WS-SR01540

8" Plastic handle scraper with reversible 4" sharp double edge is ideal for removing chewing gum, tape and paint
 Le grattoir à poignée en plastique (8 po) avec une lame à double tranchant réversible (4 po) est idéal pour enlever de la gomme à mâcher, du ruban adhésif et de la peinture.

* FH-W360-1T Handle Sold Separately. Refer to Page ----
 * FH-W360-1T Le manche est vendu séparément. Référez-vous à la page ---

| M2 Code Code M2 | Description | Pack Wt LB (S) Poids (lb) (S) | Pack Wt KG Poids (kg) | Cubic Ft Pi3 | Pack Contenu | List Price Liste des prix |
|--------------------|---|----------------------------------|--------------------------|-----------------|-----------------|------------------------------|
| WS-SR01510 | 8 1/2"/24 cm Small Plastic Handle Scraper with Cover / Petit grattoir à poignée en plastique 8 1/2 po/24 cm, avec protège-lame | 49 | 22 | 1.4 | 10 | \$ 22.33 |
| WS-SR01530 | 11 1/2"/30 cm Large Scraper / Grand grattoir, 11 1/2 po/30 cm | 36 | 16.5 | 1.4 | 10 | \$ 14.74 |
| WS-SR01540 | 4" Scraper Refill Blades - Singles / Lames de recharge | | | | 10 | \$ 0.96 |
| WS-SCR1640 | 10" /24 cm Aluminum Scraper with Handle / 10"/24cm Grattoir en aluminium avec manche | | | | 10 | \$ 31.24 |
| WS-SCR1641 | 4" Scraper Refill Blades – Dispenser Pack (10 Blades) / Lames de recharge (10) pour grattoir Flex, 4 po | | | | 10 | \$ 18.16 |
| WS-SC48 | 4" / 10 cm Wide Flex Scraper with 48"/121 cm Handle / Grattoir Flex de 4 po/ 10 cm de largeur, manche de 48 po/121 cm | 10.35 | 4.6 | 1.5 | 5 | \$ 40.58 |
| WS-SCR56 | Maxi Scrap floor scraper (Aluminum Handle L-150 cm Blade L-17cm x W-3,5cm /60" x 6.6" x 1.37") - Maxi scrap grattoir pour sols manche aluminium-150 cm Recharge lame L-17cm x W-3,5 cm /60 x 6.6" x 1.37 po | | | | 10/1 | \$ 99.79 |
| WS-SCR56R | Maxi scrap floor scraper Refill Blades - L-17 cm x W-3.5 cm / 6.6" x 1.37" - Maxi scrap Recharge lame L-17cm x W-3.5 cm/ 6.6 x 1.37 po | | | | 10/1 | \$ 9.67 |



MICROPAD VELCRO SYSTEM / SYSTÈME TAMPON "MICROPAD" VELCRO

The MicroPads are the next generation in microfibre cleaning. Made with Ultrafine microfibers, a better removal of dirt and bacteria is achieved versus the traditional method. Can be used wet dry or damp cleaning The colour code fringe helps reduce cross contamination. Velcro backing provides durability and attaches more securely to the frame.

Les "MicroPad" sont la prochaine génération en nettoyage microfibre. Fait de microfibres ultra-fine, ils assurent une meilleure élimination de la saleté et des bactéries, versus la vieille méthode traditionnelle. Peut être utiliser mouillé, sec ou humide. La frange de couleur codée aide à réduire la contamination croisée. La doublure de velcro dure plus longtemps et s'attache plus facilement au châssis.



18" / 45 cm



| M2 Code Code M2 | Description | Pack Wt LB (5) Poids (lb) (5) | Pack Wt KG Poids (kg) | Cubic Ft Pi3 | Pack Contenu | List Price Liste des prix |
|--------------------|---|----------------------------------|--------------------------|-----------------|-----------------|------------------------------|
| MFP-4010-BL | MicroFiber Pads -10" / 25cm - Blue / Tampons M-Fibre 10" / 25 cm - bleu | | | | 12 | \$ 9.96 |
| MFP-4018-BL | MicroFiber Pads -18" / 45cm Blue / Tampons M-Fibre 18" / 45cm - bleu | | | | 12 | \$ 11.57 |
| MFP-4018-RD | MicroFiber Pads -18" / 45 cm - Red / Tampons M-Fibre 18" / 45 cm - rouge | | | | 12 | \$ 11.57 |
| MFP-4018-YE | MicroFiber Pads -18" / 45 cm - Yellow / Tampons M-Fibre 18" / 45 cm - jaune | | | | 12 | \$ 11.57 |
| MFP-4018-GN | MicroFiber Pads -18" / 45 cm - Green / Tampons M-Fibre 18" / 45 cm - vert | | | | 12 | \$ 11.57 |
| MFP-4024-BL | MicroFiber Pads -24" / 60cm Blue / Tampons M-Fibre 24" / 60cm - bleu | | | | 12 | \$ 17.12 |
| MFP-4036-BL | MicroFiber Pads -36" / 90cm Blue / Tampons M-Fibre 36" / 90cm - bleu | | | | 12 | \$ 29.53 |

MICRO STRIP VELCRO PADS / TAMPONS VELCRO

Especially on hard floors like marble, travertine, granite, porcelain. Cleaning and disinfection takes place after the mop is soaked with water and mixed with diluted detergent.

Perfect on dry stains. The micro abrasive strip removes stubborn dirt and grease without scratching the surface

Utilisé surtout sur les sols durs comme le marbre, le travertin, le granit ou la porcelaine. Le nettoyage et la désinfection ont lieu après que la vadrouille ait été préalablement imprégnée d'eau et mélangée avec un détergent dilué. Parfait sur les taches sèches. La bande micro abrasive enlève la saleté et la graisse tenace sans rayer la surface.



Micro-Fibre DryPad/w Fringe will remove more dirt and bacteria than old traditional methods.

With the added looped fringe the Micro-dry pad picks up and holds even more dust and larger debris

Le tampon sec en microfibres avec frange éliminera plus de saleté et de bactéries que les anciennes méthodes traditionnelles. Avec la frange bouclée ajoutée, le tampon micro-sec ramasse et retient encore plus de poussière et de plus gros débris.

The MicroStrip replacement pad is ideal for both wet and dry cleaning / La recharge de tampon "Microstrip" est idéale aussi bien pour le nettoyage humide ou sec.

| VELCRO MICROSTRIP PAD / TAMPON MICROSTRIP VELCRO | | | | | | |
|--|---|------|-----|--|------|----------|
| EFM-FMV64510 | Velcro Flat Mop MicroStrip MicroFiber Pad 10" / 25 cm white/w stripe / Tampon Velcro en microfibre pour vadrouille plate "MicroStrip" 10" / 25 cm blanc/ rayures | | | | 12/1 | \$ 17.22 |
| EFM-FMV64516 | Velcro Flat Mop MicroStrip MicroFiber Pad 16" / 40 cm white/w stripe / Tampon Velcro en microfibre pour vadrouille plate "MicroStrip" 16" / 40 cm blanc/ rayures | 6.3 | 3 | | 12/1 | \$ 18.32 |
| EFM-FMV64518 | Velcro Flat Mop MicroStrip MicroFiber Pad 18" / 45 cm white/w stripe / Tampon Velcro en microfibre pour vadrouille plate "MicroStrip" 18" / 45 cm blanc/ rayures | 7.2 | 3.3 | | 12/1 | \$ 19.21 |
| EFM-FMV64524 | Velcro Flat Mop MicroStrip MicroFiber Pad 24" / 60 cm white/w stripe / Tampon Velcro en microfibre pour vadrouille plate "MicroStrip" 24" / 60 cm blanc/ rayures | 9.4 | 4.3 | | 12/1 | \$ 21.82 |
| EFM-FMV64540 | Velcro Flat Mop MicroStrip MicroFiber Pad 40" / 100 cm white/w stripe / Tampon Velcro en microfibre pour vadrouille plate "MicroStrip" 40" / 100cm blanc/ rayures | 15.1 | 6.9 | | 12/1 | \$ 55.96 |
| VELCRO MICROFIBER DRYPAD WITH FRINGE / VELCRO MICROFIBER DRYPAD AVEC FRANGES | | | | | | |
| MFP-5518 | 18" / 45 cm Micro-Fibre DryPad with Fringe - Green / DryPad microfibre de 18 po / 45 cm avec franges - vert | | | | 12/6 | \$ 27.26 |
| MFP-5524 | 24" / 60 cm Micro-Fibre DryPad with Fringe - Green / DryPad microfibre de 24" / 60 cm avec franges - ver | | | | 12/6 | \$ 32.34 |
| MFP-5536 | 36" / 91 cm Micro-Fibre DryPad with Fringe - Green / DryPad microfibre de 36" / 91 cm avec franges - ver | | | | 12/6 | \$ 50.20 |

MICRO STRIP VELCRO PADS / TAMPONS VELCRO

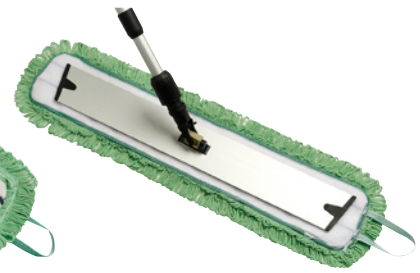

| M2 Code Code M2 | Description | Pack Wt LB (S) Poids (lb) (S) | Pack Wt KG Poids (kg) | Cubic Ft Pi3 | Pack Contenu | List Price Liste des prix |
|---|--|----------------------------------|--------------------------|-----------------|-----------------|------------------------------|
| MICROLIGHT VELCRO FLAT MOP MICROFIBER PAD | | | | | | |
| EFM-FM64410 | 10"/25 cm MicroLight Velcro Flat Mop MicroFiber Pad - White with Blue Soft Scrub Strip / | | | | 12/1 | \$ 16.31 |
| EFM-FM64416 | 16"/40 cm MicroLight Velcro Flat Mop MicroFiber Pad 10"/25 cm White with Blue Soft Scrub Strip / | | | | 12/1 | \$ 17.40 |
| EFM-FM64418 | 18"/45 cm MicroLight Velcro Flat Mop MicroFiber Pad 10"/25 cm White with Blue Soft Scrub Strip / | | | | 12/1 | \$ 18.25 |
| EFM-FM64424 | 24"/60 cm MicroLight Velcro Flat Mop MicroFiber Pad 10"/25 cm White with Blue Soft Scrub Strip / | | | | 12/1 | \$ 20.73 |
| EFM-FM64436 | 36"/92 cm MicroLight Velcro Flat Mop MicroFiber Pad 10"/25 cm White with Blue Soft Scrub Strip / | | | | 12/1 | \$ 53.16 |
| MICROSTRIP VELCRO MICROFIBER PAD WITH FRINGE | | | | | | |
| EFM-FMV64710 | 10"/25 cm MicroStrip Velcro MicroFiber Pad with Fringe Flat Mop | | | | 12 | \$ 17.78 |
| EFM-FMV64716 | 16"/40 cm MicroStrip Velcro MicroFiber Pad with Fringe Flat Mop | | | | 12 | \$ 18.86 |
| EFM-FMV64718 | 18"/45 cm MicroStrip Velcro MicroFiber Pad with Fringe Flat Mop | | | | 12 | \$ 19.79 |
| EFM-FMV64724 | 24"/60 cm MicroStrip Velcro MicroFiber Pad with Fringe Flat Mop | | | | 12 | \$ 22.48 |
| EFM-FMV64736 | 36"/92 cm MicroStrip Velcro MicroFiber Pad with Fringe Flat Mop | | | | 12 | \$ 57.64 |

VELCRO ECONOMICAL FLAT MOPPING SYSTEMS / SYSTÈME DE TAMPONS VELCRO PLATS ÉCONOMIQUESZ

M-TECH FLAT MICROFIBRE MOP PAD / TAMPON DE VADROUILLE PLATE EN MICROFIBRE M-TECH

WET / HUMIDE



DRY / SEC



WET-DRY / HUMIDE-SEC



| M2 Code Code M2 | Description | Pack Wt LB (S) Poids (lb) (S) | Pack Wt KG Poids (kg) | Cubic Ft Pi3 | Pack Contenu | List Price Liste des prix |
|---|---|----------------------------------|--------------------------|-----------------|-----------------|------------------------------|
| M-TECH DRY VELCRO MOPPAD / TAMPON VELCRO DE VADROUILLE SÈCHE " " | | | | | | |
| MFP-V5210-GY | M-Tech Velcro Flat Microfiber Mop Pad - 10"/25 cm - Dry - Grey / "M-Tech" Tampon de vadrouille plate en microfibre avec velcro - 10"/25 cm - sec - gris | | | | 12/1 | \$ 20.11 |
| MFP-V5216-GY | M-Tech Velcro Flat Microfiber Mop Pad - 16"/40 cm - Dry - Grey / "M-Tech" Tampon de vadrouille plate en microfibre avec velcro - 16"/40 cm - sec - gris | | | | 12/1 | \$ 21.49 |
| MFP-V5218-GY | M-Tech Velcro Flat Microfiber Mop Pad - 18"/45 cm - Dry - Grey / "M-Tech" Tampon de vadrouille plate en microfibre avec velcro - 18"/45 cm - sec - gris | | | | 12/1 | \$ 22.82 |
| MFP-V5224-GY | M-Tech Velcro Flat Microfiber Mop Pad - 24"/60 cm - Dry - Grey / "M-Tech" Tampon de vadrouille plate en microfibre avec velcro 24"/60 cm - sec - gris | | | | 12/1 | \$ 28.85 |
| MFP-V5236-GY | M-Tech Velcro Flat Microfiber Mop Pad - 36"/92 cm - Dry - Grey / "M-Tech" Tampon de vadrouille plate en microfibre avec velcro 36"/92 cm - sec - gris | | | | 12/1 | \$ 44.57 |
| M-TECH PET WET/DRY VELCRO MOPPAD / TAMPON VELCRO DE VADROUILLE HUMIDE-SÈCHE "M-TECH PET" | | | | | | |
| MFP-V4310 | PET Velcro Flat Microfiber Mop Pad 10"/25 cm - Green/White - Wet-Dry / PET Tampon microfibre de vadrouille plate avec velcro 10"/25 cm - Vert/Blanc - Humide/Sec | | | | 12/1 | \$ 20.11 |
| MFP-V4316 | PET Velcro Flat Microfiber Mop Pad 16"/40 cm - Green/White - Wet-Dry / PET Tampon microfibre de vadrouille plate avec velcro 16"/40 cm - Vert/Blanc - Humide/Sec | | | | 12/1 | \$ 21.49 |
| MFP-V4318 | PET Velcro Flat Microfiber Mop Pad 18"/45 cm - Green/White - Wet-Dry / PET Tampon microfibre de vadrouille plate avec velcro 18"/45 cm - Vert/Blanc - Humide/Sec | | | | 12/1 | \$ 22.82 |
| MFP-V4324 | PET Velcro Flat Microfiber Mop Pad 24"/60 cm - Green/White - Wet-Dry / PET Tampon microfibre de vadrouille plate avec velcro 24"/60 cm - Vert/Blanc - Humide/Sec | | | | 12/1 | \$ 28.85 |
| MFP-V4336 | PET Velcro Flat Microfiber Mop Pad 36"/90 cm - Green/White - Wet-Dry / PET Tampon microfibre de vadrouille plate avec velcro 36"/90 cm - Vert/Blanc - Humide/Sec | | | | 12/1 | \$ 44.57 |



M-TECH FLAT MICROFIBRE MOP PAD / TAMPON DE VADROUILLE PLATE EN MICROFIBRE M-TECH



| M2 Code Code M2 | Description | Pack Wt LB (S) Poids (lb) (S) | Pack Wt KG Poids (kg) | Cubic Ft Pi3 | Pack Contenu | List Price Liste des prix |
|---|---|----------------------------------|--------------------------|-----------------|-----------------|------------------------------|
| M-TECH WET VELCRO FLAT MOP - GREEN / M-TECH VADROUILLE PLATE HUMIDE - VERTE | | | | | | |
| MFP-V4210-GN | M-Tech Velcro Flat Microfiber Mop Pad - 10"/ 25 cm - Dry - Green / "M-Tech" Tampon de vadrouille plate en microfibre avec velcro - 10"/25 cm - sec - vert | | | | 12/1 | \$ 20.11 |
| MFP-V4216-GN | M-Tech Velcro Flat Microfiber Mop Pad - 16"/ 40 cm - Dry - Green/ "M-Tech" Tampon de vadrouille plate en microfibre avec velcro - 16"/40 cm - sec - vert | | | | 12/1 | \$ 21.49 |
| MFP-V4218-GN | M-Tech Velcro Flat Microfiber Mop Pad - 18"/ 45 cm - Dry - Green / "M-Tech" Tampon de vadrouille plate en microfibre avec velcro - 18"/45 cm - sec - vert | | | | 12/1 | \$ 22.82 |
| MFP-V4224-GN | M-Tech Velcro Flat Microfiber Mop Pad - 24"/ 60 cm - Dry - Green / "M-Tech" Tampon de vadrouille plate en microfibre avec velcro 24"/60 cm - sec - vert | | | | 12/1 | \$ 28.85 |
| MFP-V4236-GN | M-Tech Velcro Flat Microfiber Mop Pad - 36"/ 92 cm - Dry - Green/ "M-Tech" Tampon de vadrouille plate en microfibre avec velcro 36"/92 cm - sec - vert | | | | 12/1 | \$ 44.57 |
| M-TECH WET VELCRO FLAT MOP - BLUE / M-TECH VADROUILLE PLATE HUMIDE - BLEU | | | | | | |
| MFP-V4210-BL | M-Tech Velcro Flat Microfiber Mop Pad - 10"/ 25 cm - Wet- Blue / "M-Tech" Tampon de vadrouille plate en microfibre avec velcro - 10"/25 cm - humide - bleu | | | | 12/1 | \$ 20.11 |
| MFP-V4216-BL | M-Tech Velcro Flat Microfiber Mop Pad - 16"/ 40 cm - Wet- Blue/ "M-Tech" Tampon de vadrouille plate en microfibre avec velcro - 16"/40 cm - humide - bleu | | | | 12/1 | \$ 21.49 |
| MFP-V4218-BL | M-Tech Velcro Flat Microfiber Mop Pad - 18"/ 45 cm - Wet- Blue / "M-Tech" Tampon de vadrouille plate en microfibre avec velcro - 18"/45 cm - humide - bleu | | | | 12/1 | \$ 22.82 |
| MFP-V4224-BL | M-Tech Velcro Flat Microfiber Mop Pad - 24"/ 60 cm - Wet- Blue / "M-Tech" Tampon de vadrouille plate en microfibre avec velcro 24"/60 cm - humide - bleu | | | | 12/1 | \$ 28.85 |
| MFP-V4236-BL | M-Tech Velcro Flat Microfiber Mop Pad - 36"/ 92 cm - Wet- Blue / "M-Tech" Tampon de vadrouille plate en microfibre avec velcro 36"/92 cm - humide - bleu | | | | 12/1 | \$ 44.57 |
| M-TECH WET VELCRO FLAT MOP - RED / M-TECH VADROUILLE PLATE HUMIDE - ROUGE / | | | | | | |
| MFP-V4210-RD | M-Tech Velcro Flat Microfiber Mop Pad - 10"/ 25 cm - Dry - Red / "M-Tech" Tampon de vadrouille plate en microfibre avec velcro - 10"/25 cm - sec - rouge | | | | 12/1 | \$ 20.11 |
| MFP-V4216-RD | M-Tech Velcro Flat Microfiber Mop Pad - 16"/ 40 cm - Dry - Red / "M-Tech" Tampon de vadrouille plate en microfibre avec velcro - 16"/40 cm - sec - rouge | | | | 12/1 | \$ 21.49 |
| MFP-V4218-RD | M-Tech Velcro Flat Microfiber Mop Pad - 18"/ 45 cm - Dry -Red / "M-Tech" Tampon de vadrouille plate en microfibre avec velcro - 18"/45 cm - sec - rouge | | | | 12/1 | \$ 22.82 |
| MFP-V4224-RD | M-Tech Velcro Flat Microfiber Mop Pad - 24"/ 60 cm - Dry - Red / "M-Tech" Tampon de vadrouille plate en microfibre avec velcro 24"/60 cm - sec - rouge | | | | 12/1 | \$ 28.85 |
| MFP-V4236-RD | M-Tech Velcro Flat Microfiber Mop Pad - 36"/ 92 cm - Dry -Red / "M-Tech" Tampon de vadrouille plate en microfibre avec velcro 36"/92 cm - sec - rouge | | | | 12/1 | \$ 44.57 |
| M-TECH DRY VELCRO FLAT MOP - YELLOW / M-TECH VADROUILLE PLATE HUMIDE - JAUNE | | | | | | |
| MFP-V4210-YE | M-Tech Velcro Flat Microfiber Mop Pad - 10"/ 25 cm - Dry - Yellow / "M-Tech" Tampon de vadrouille plate en microfibre avec velcro - 10"/25 cm - sec -jaune | | | | 12/1 | \$ 20.11 |
| MFP-V4216-YE | M-Tech Velcro Flat Microfiber Mop Pad - 16"/ 40 cm - Dry - Yellow / "M-Tech" Tampon de vadrouille plate en microfibre avec velcro - 16"/40 cm - sec -jaune | | | | 12/1 | \$ 21.49 |
| MFP-V4218-YE | M-Tech Velcro Flat Microfiber Mop Pad - 18"/ 45 cm - Dry - Yellow / "M-Tech" Tampon de vadrouille plate en microfibre avec velcro - 18"/45 cm - sec -jaune | | | | 12/1 | \$ 22.82 |
| MFP-V4224-YE | M-Tech Velcro Flat Microfiber Mop Pad - 24"/ 60 cm - Dry - Yellow/ "M-Tech" Tampon de vadrouille plate en microfibre avec velcro 24"/60 cm - sec -jaune | | | | 12/1 | \$ 28.85 |
| MFP-V4236-YE | M-Tech Velcro Flat Microfiber Mop Pad - 36"/ 92 cm - Dry - Yellow / "M-Tech" Tampon de vadrouille plate en microfibre avec velcro 36"/92 cm - sec -jaune | | | | 12/1 | \$ 44.57 |

18"/45 CM MICROFIBER VELCRO FRAME / CHÂSSIS POUR MICROFIBRE VELCRO 18"/45 CM

The MicroFiber Velcro Aluminum Frame has a trapezoid shape designed for corners. It has a 360° degree swivel head which allows for easier movement of frame on the floor. Interlocking collar allows for most types of handles.

Le châssis velcro en aluminium pour microfibre a une forme de trapèze conçu pour les coins. Il possède une tête pivotante sur 360 qui facilite les mouvements du châssis sur le plancher. Le collet d'emboîtement accepte le plus part des types de manches



Swivel Head /
Tete pivotante

VELCRO FRAMES/ CADRE POUR VELCRO



10"
25 CM



16"
40 CM



18"
45 CM



24"
60 CM



40"
100 CM

Closed 39" / 100cm - Extended 70" / 180cm



FH-A3180

| M2 Code Code M2 | Description | Pack Wt LB (S) Poids (lb) (S) | Pack Wt KG Poids (kg) | Cubic Ft Pi3 | Pack Contenu | List Price Liste des prix |
|--|---|----------------------------------|--------------------------|-----------------|-----------------|------------------------------|
| MFF-7410 | Velcro Frame Only 10" / 25 cm / Cadre pour Velcro seulement 10 po / 25 cm | | | | 10/1 | \$ 29.90 |
| MFF-7416 | Velcro Frame Only 16" / 40 cm / Cadre pour Velcro seulement 16 po / 40 cm | 10.4 | 4.7 | | 10/1 | \$ 29.90 |
| MFF-7418 | Velcro Frame Only 18" / 45 cm / Cadre pour Velcro seulement 18 po / 45 cm | 11 | 5 | | 10/1 | \$ 35.62 |
| MFF-7424 | Velcro Frame Only 24" / 60 cm / Cadre pour Velcro seulement 24 po / 60 cm | 13.7 | 6.2 | | 10/1 | \$ 40.82 |
| MFF-7436 | Velcro Frame Only 36" / 91 cm / Cadre pour Velcro seulement 36 po / 100 cm | 24.5 | 11 | | 10/1 | \$ 56.43 |
| TELESCOPIC NON THREADED HANDLE / MANCHE TÉLESCOPIQUE NON FILETÉ | | | | | | |
| FH-A3180 | Telescopic Non Threaded Handle - 39"-70"-100cm-180 cm / Manche télescopique non fileté 39"-70"-100cm-180 cm | | | | 20/1 | \$ 20.97 |



**1 18"/45 CM SWIPE-IT VELCRO FRAME KIT WITH BLUE M-FIBRE PAD /
18" /45 CM CADRE "SWIPE-IT" VELCRO AVEC TAMPON BLEU MICROFIBRE**



INCLUDES:

- 18" / 45 cm Blue M-Fibre, Velcro Flat Pad
- 18" / 45 cm Velcro Frame
- Telescopic Metal Handle - 39" - 70" / 100 - 180 cm

COMPREND:

- 18" / 45 cm Vadrouille en microfibre
- 18" / 45 cm Cadre pour Velcro
- Manche télescopique fileté - 39 - 70 po / 100 - 180 cm



| M2 Code Code M2 | Description | Pack Wt LB (S) Poids (lb) (S) | Pack Wt KG Poids (kg) | Cubic Ft Pi3 | Pack Contenu | List Price Liste des prix |
|--------------------|--|----------------------------------|--------------------------|-----------------|-----------------|------------------------------|
| MFK-V50018 | Swipe-It Velcro Frame Kit/w/18" Blue M-Fibre Pad, Velcro Frame & Telescopic Handle / Ensemble de Tampons Swipe it avec cadre Velcro /18 pouces bleu manche télescopique | | | | 1 | \$ 54.45 |

**2 16"/40 CM AND 18"/45 CM SWIPE-IT M-TECK MICROSTRIP KIT /
ENSEMBLE COMPLET EN VELCRO 16 PO 40 CM "MICROSTRIP"**



INCLUDES:

- 16" / 40 cm or 18" / 45 cm MicroStrip Microfiber pad.
- 16" / 40 cm or 18" / 45 cm Velcro Frame
- Telescopic Metal Handle - 39" - 70" / 100 - 180 cm

COMPREND:

- 16" / 40 cm ou 18" / 45 cm Tampon Velcro en microfibre pour MicroStrip
- 16" / 40 cm ou 18" / 45 cm Cadre pour Velcro
- Manche télescopique fileté - 39 - 70 po / 100 - 180 cm



| M2 Code Code M2 | Description | Pack Wt LB (S) Poids (lb) (S) | Pack Wt KG Poids (kg) | Cubic Ft Pi3 | Pack Contenu | List Price Liste des prix |
|--------------------|--|----------------------------------|--------------------------|-----------------|-----------------|------------------------------|
| MFK-V60016 | Velcro Frame Kit with 16" / 40 cm MicroStrip 16" / 40 cm Pad & Telescopic Handle / Cadre pour Velcro seulement 16 po / 40 cm "MicroStrip" 16 po / 40 cm blanc/rayures/Manche télescopique | | | | 10/1 | \$ 61.25 |
| MFK-V7418-Kit | Swipe-It Velcro Frame Kit with 18" / 45 cm Micro Strip Pad & Telescopic Locking Adapter / Cadre pour Velcro seulement Swipe-It 18 po / 45 cm "M-Tech" 18 po / 45 cm rayures/Adaptateur de verrouillage télescopique | | | | 10/1 | \$ 62.51 |

**3 16"/40 CM M-TECK MICRO PET KIT /
ENSEMBLE COMPLET EN VELCRO 16 PO 40 CM "MICRO PET"**



INCLUDES:

- 16" / 40 cm Micro PET, Velcro Flat Microfiber Pad
- 16" / 40 cm Velcro Frame
- Telescopic Metal Handle - 39" - 70" / 100 - 180 cm

COMPREND:

- 16" / 40 cm Vadrouille en microfibre Micro-Pet
- 16" / 40 cm Cadre pour Velcro
- 16" / 40 cm Manche télescopique fileté - 39 - 70 po / 100 - 180 cm



| M2 Code Code M2 | Description | Pack Wt LB (S) Poids (lb) (S) | Pack Wt KG Poids (kg) | Cubic Ft Pi3 | Pack Contenu | List Price Liste des prix |
|--------------------|--|----------------------------------|--------------------------|-----------------|-----------------|------------------------------|
| MFK-V80016 | Velcro Frame Kit with 16" / 40 cm Micro PET 16" / 40 cm Pad & Telescopic Handle / Cadre pour Velcro seulement 16 po / 40 cm "Micro PET" 16 po / 40 cm rayures/Manche télescopique | | | | 10/1 | \$ 65.54 |

**4 16"/40 CM M-TECH MICROFIBER KIT /
ENSEMBLE COMPLET EN VELCRO 16 PO 40 CM "M-TECH"**



INCLUDES:

- 16" / 40 cm M-Tech Velcro Flat Microfiber Mop Pad - Grey
- 16" / 40 cm Velcro Frame
- 16" / 40 cm Telescopic Metal Handle - 39" - 70" / 100 - 180 cm

COMPREND:

- 16" / 40 cm "M-Tech" Tampon de vadrouille plate en microfibre avec velcro - gris
- 16" / 40 cm Cadre pour Velcro
- 16" / 40 cm Manche télescopique fileté - 39 - 70 po / 100 - 180 cm



| M2 Code Code M2 | Description | Pack Wt LB (S) Poids (lb) (S) | Pack Wt KG Poids (kg) | Cubic Ft Pi3 | Pack Contenu | List Price Liste des prix |
|--------------------|---|----------------------------------|--------------------------|-----------------|-----------------|------------------------------|
| MFK-V70016 | Velcro Frame Ki with 16" / 40 cm M-Tech 16" / 40 cm Pad & Telescopic Handle / Cadre pour Velcro seulement 16 po / 40 cm "M-Tech" 16 po / 40 cm rayures/Manche télescopique | | | | 10/1 | \$ 67.96 |

**5 18"/45 CM SWIPE-IT VELCRO FRAME KIT WITH MICRO FIBER DRYPAD WITH FRINGE /
18" /45 CM CADRE "SWIPE-IT" VELCRO AVEC TAMPON MICROFIBRE SEC AVEC FRANGE**



INCLUDES:

- 18" / 45 cm Micro Fibre DryPad with Fringe
- 18" / 45 cm Velcro Frame
- Telescopic Metal Handle - 39" - 70" / 100 - 180 cm

COMPREND:

- 18" / 40 cm Vadrouille en microfibre
- 18" / 45 cm Cadre pour Velcro
- Manche télescopique fileté - 39 - 70 po / 100 - 180 cm



| M2 Code Code M2 | Description | Pack Wt LB (S) Poids (lb) (S) | Pack Wt KG Poids (kg) | Cubic Ft Pi3 | Pack Contenu | List Price Liste des prix |
|--------------------|---|----------------------------------|--------------------------|-----------------|-----------------|------------------------------|
| MFK-V90018 | Swipe-It Velcro Frame Kit/w/18" Micro-Fibre DryPad/w Fringe, Velcro Frame & Telescopic Handle / Ensemble de Tampons pour le sec Swipe it avec cadre Velcro /18 pouces bleu manche télescopique | | | | 1 | \$ 65.68 |



SPRAY XPRESS FLOOR & WAXING TOOL / VAPORISATEUR POUR PLANCHER ET OUTIL DE CIRAGE



32 OZ / 946 ML
BOTTLE CAPACITY /
LA CAPACITÉ DE LA
BOUTEILLE

To be used with Velcro frame /
À utiliser avec le cadre "Velcro"



INTENSE DUSTING CLEANING AND MOPPING / TAMPON À POUSSIÈRE ET VADROUILLE DE NETTOYAGE

This microfiber pad used for general cleaning and wet mopping in high traffic areas. The Microfiber yarn is washable up to 800 times and can be used wet or dry. Low friction with no drag can mechanically clean with minimal chemical use.

Ce tampon en microfibre est utilisé pour le nettoyage général et le lavage dans les zones à fort trafic. Les fibres de microfibre sont lavables jusqu'à 800 fois et peuvent être utilisées humide ou sec. Le faible frottement, sans glissement peut nettoyer mécaniquement avec une utilisation minimale de produits chimiques.

INTENSE WET CLEANING PADS / TAMPONS DE NETTOYAGE INTENSE

This micro fiber pad allows you to dust and wet mop. Microfiber yarn is washable can be used wet or dry. Low friction with no drag can mechanically clean with minimal chemical use.

Ce tampon en microfibre vous permet d'enlever la poussière et nettoyer. La microfibre est lavable et peut être utilisée humide ou sec. Le faible frottement, sans glissement peut nettoyer mécaniquement avec une utilisation minimale de produits chimiques.

WAXING / CIRAGE

are recommended for use with burnished floor finishes. Les vadrouilles "glacier" sont recommandées pour une utilisation avec des finitions de plancher lustré.

| M2 Code Code M2 | Description | Pack Wt LB (S) Poids (lb) (S) | Pack Wt KG Poids (kg) | Cubic Ft Pi3 | Pack Contenu | List Price Liste des prix |
|--------------------|---|----------------------------------|--------------------------|-----------------|-----------------|------------------------------|
| SE-9000 | Spray Xpress Floor Mop Tool / Outil pour vadrouille Spray express pour plancher | 4 | 1.81 | .63 | 1 | \$ 209.93 |
| MFP-V4216-BL | M-Tech Velcro Flat Microfiber Mop Pad - 16" / 40 cm - Blue - Wet "M-Tech" Tampon de vadrouille plate en microfibre avec velcro - 16" / 40 cm - sec - bleu | | | | 10/1 | \$ 21.49 |
| MFP-V5216-GY | M-Tech Velcro Flat Microfiber Mop Pad - 16" / 40 cm - Grey - Dry "M-Tech" Tampon de vadrouille plate en microfibre avec velcro - 16" / 40 cm - humide - gris | | | | 10/1 | \$ 21.49 |
| DM-WV516 | Glacier Nylon Velcro MopPad - 5" x 16" / 13 x 40 cm Vadrouilles à poussière en nylon "Glacier", 5 x 16" / 40 cm x 13 cm - Velcro | | | | 12/1 | \$ 19.87 |

DUO MICROFIBER SYSTEM / SYSTÈME DOUBLE FACE EN MICROFIBRE



| M2 Code Code M2 | Description | Pack Wt LB (S) Poids (lb) (S) | Pack Wt KG Poids (kg) | Cubic Ft Pi3 | Pack Contenu | List Price Liste des prix |
|--------------------|--|----------------------------------|--------------------------|-----------------|-----------------|------------------------------|
| FM-P1000 | Duo Frame - 40cm/16" / Cadre double, 40cm / 16 po | 8 | 3.6 | .5 | 10/1 | \$ 21.21 |
| FM-P1001 | Duo Microfiber Mop - Blue - 40cm/16" / Vadrouille double face en microfibre, bleu, 40 cm / 16 po | 8.5 | 4 | 1.5 | 10/1 | \$ 12.49 |

STATIC ATTACK



M2's Static Attack sheets use an electrostatic charge to attract fine dust and particles. Ideal in facilities where cross-contamination is a concern, One sheet per room is recommended

• Ideal for hospitals, nursing homes, office buildings, classrooms and stores. • Eliminates the need for laundering

Les feuilles de "Static Attack" de M2 utilisent une charge électrostatique pour attirer la poussière fine et les particules. Idéal dans les installations où la contamination croisée est une préoccupation. Une feuille par pièce est recommandée.

• Idéal pour les hôpitaux, les maisons de soins infirmiers, les immeubles de bureaux, les salles de classe et les magasins.
• Élimine le besoin de laver.

| M2 Code Code M2 | Description | Pack Wt LB (S) Poids (lb) (S) | Pack Wt KG Poids (kg) | Cubic Ft Pi3 | Pack Contenu | List Price Liste des prix |
|---|--|----------------------------------|--------------------------|-----------------|-----------------|------------------------------|
| STA-2368 | Static Attack Mop Sheets - 23.6" x 8" - 200 per case / Feuilles pour vadrouille "Static Attack" 200 par caisse | | | | 200/1 | \$ 216.91 |
| STA-2369 | 24"/60 cm Static Attack Frame / Cadre de vadrouille "Static Attack" - 24"/60 cm | | | | 1 | \$ 100.20 |
| STA-2370 | "Static Attack" Mop Frame 24" and Aluminum Telescopic Handle (Closed 39"-100 cm - Ext. 71"-180 cm) | | | | 1 | \$ 115.40 |
| STA-2371 | "Static Attack" Mop Frame 47" / 120 cm and Aluminum Telescopic Handle (Closed 71"-180 cm) | | | | 1 | \$ 392.95 |
| TELESCOPIC ALUMINUM HANDLE - NON THREADED / MANCHE TÉLESCOPIQUE EN ALUMINIUM | | | | | | |
| FH-A3180 | Telescopic Non Threaded Handle - 100 -180 cm / Manche télescopique non fileté 100"/180 cm | | | | 20/1 | \$ 20.97 |



COLLAPSIBLE FLAT MOPPING SYSTEM / SYSTÈME DE VADROUILLE PLATE PLIANTE THE OLYMPIC FRAME / LE CHÂSSIS OLYMPIC



EFM-FM5000



**IDEAL FOR HEALTHCARE MARKET /
IDÉAL POUR LE MARCHÉ DES SOINS DE SANTÉ**



The Olympic frame has been designed and created for different cleaning areas and to be used in different ways, depending on customer needs. It adapts itself to any mop or cloth on the market.

Olympic is equipped with removable and replaceable Velcro. The opening - closing allows the operator to avoid touching the dirty mop after use, thus guaranteeing maximum hygiene and safety.

Le châssis Olympic a été conçu et créé pour différentes zones de nettoyage et pour être utilisé de différentes façons, dépendant des besoins des clients. Il s'adapte à plusieurs tampons ou chiffons sur le marché.

Olympic est équipé d'un velcro amovible et remplaçable. L'ouverture/fermeture permet à l'opérateur d'éviter de toucher le tampon souillé après usage, de même il garantit un maximum d'hygiène et de sécurité.

POCKET STYLE / STYLE POCHE



STEP 1 / ÉTAPE 1

Pick up mop from Presoaked MopBox
Retirer le tampon du baquet de
Pré-trempage



STEP 2 / ÉTAPE 2

Wash floor or patient room
Laver le plancher ou la chambre
du patient



STEP 3 / ÉTAPE 3

Step on clip to collapse frame
Marcher sur l'attache pour plier
le châssis



STEP 4 / ÉTAPE 4

Drop mop pad into laundry bag
Jeter le tampon dans le sac de
lavage

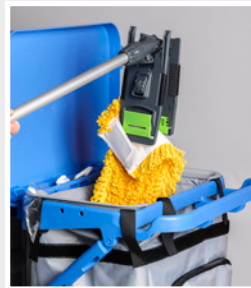

Olympic frame and Microloop mop are also ideal for washing walls

Le châssis Olympic et le tampon "Microloop" sont aussi idéals pour le lavage des murs.

**TAB STYLE COLLAPSIBLE SYSTEM /
SYSTÈME PLIANT À LANGUETTES**



MOPPADS / TAMPONS

ALL OUR MOPPAD REFILLS ARE AVAILABLE IN TAB, VELCRO, POCKET AND T-TAB STYLES /

TOUS NOS RECHANGES DE TAMPONS SONT DISPONIBLES DANS LE STYLE LANGUETTE, VELCRO, POCLETTE ET LANGUETTE EN T



MICROLOOP

Mainly used for wet mopping in medium/highly soiled floors these refills are environmentally friendly requiring less chemicals
Constructed with durable backing and long lasting microfiber yarn for the toughest jobs and repeated launderings. The microfiber yarn allows for better liquid retention and better floor coverage. It can withstand hundreds of launderings.

MICROLOOP

Principalement utilisés pour le nettoyage humide sur les planchers de moyennement à hautement souillés ces tampons de rechange sont respectueux de l'environnement et requiert moins de produits chimiques..
Bâtit avec un endos durable et des fils de microfibre durables pour les gros travaux et les lavages répétés. Le codage de couleur des fils de microfibre permet une meilleure rétention des liquides et une meilleure couverture du sol. Ils peuvent supporter des centaines de lavages.

**IDEAL FOR HEALTHCARE MARKET /
IDÉAL POUR LE MARCHÉ DES SOINS DE SANTÉ**



EFM-FM5000

Closed 39" / 100cm - Extended 70" / 180cm



FH-A3180



| M2 Code Code M2 | Description | Pack Wt LB (S) Poids (lb) (S) | Pack Wt KG Poids (kg) | Cubic Ft Pi3 | Pack Contenu | List Price Liste des prix |
|--|--|----------------------------------|--------------------------|-----------------|-----------------|------------------------------|
| EFM-FM5000 | Olympic Flat Mop Frame Only Blue Clips / Cadre Olympic pour vadrouille plate seulement attaches bleus | .9 | .4 | | 10/1 | \$ 43.57 |
| EFM-FM5100-BL | Flat Mop Looped MicroLoop fiber refill 16"/40cm Blue w/Tabs / Rechange de vadrouille plate en microfibre bouclée 16"/40cm bleu avec attaches | 12.8 | 6 | | 10/1 | \$ 26.35 |
| EFM-FM5100-RD | Flat Mop Looped MicroLoop fiber refill 16"/40cm Red w/Tabs / Rechange de vadrouille plate en microfibre bouclée 16"/40cm rouge avec attaches | 12.8 | 6 | | 10/1 | \$ 26.35 |
| EFM-FM5100-YE | Flat Mop Looped MicroLoop fiber refill 16"/40cm Yellow w/Tabs / Rechange de vadrouille plate en microfibre bouclée 16"/40cm jaune avec attaches | 12.8 | 6 | | 10/1 | \$ 26.35 |
| EFM-FM5100-GN | Flat Mop Looped MicroLoop fiber refill 16"/40cm Green w/Tabs / Rechange de vadrouille plate en microfibre bouclée 16"/40cm vert avec attaches | 12.8 | 6 | | 10/1 | \$ 26.35 |
| EFM-FM5100-WH | Flat Mop Looped MicroLoop fiber refill 16"/40cm White w/Tabs / Rechange de vadrouille plate en microfibre bouclée 16"/40cm blanc avec attaches | 12.8 | 6 | | 10/1 | \$ 26.35 |
| EFM-FM5100-GR | Flat Mop Looped MicroLoop fiber refill 16"/40cm Grey w/Tabs / Rechange de vadrouille plate en microfibre bouclée 16"/40cm Gris avec attaches | 12.8 | 6 | | 10/1 | \$ 26.35 |
| TELESCOPIC NON THREADED HANDLE / MANCHE TÉLESCOPIQUE NON FILETÉ | | | | | | |
| FH-A3180 | Telescopic Non Threaded Handle - 39"- 70"-100cm-180 cm / Manche télescopique non fileté 39"- 70"-100cm-180 cm | | | | 20/1 | \$ 20.97 |

MOPPADS / TAMPONS

EFM-FM5200



EFM-FM54016



EFM-FMT64516-T



EFM-FMT64616-T



EFM-FMT64616



TREO LOOP (3)

Treo loop flat mop pad is an all-purpose flat mop that has improved cleaning performance and long launderability

- Can be laundered 600 times at 90° C/194 °F – Three types of yarn

TREO LOOP (3)

Le tampon plat "Treo loop" est un tampon tous-usages qui a amélioré les performances de nettoyage et la résistance aux lavages.

- Peut être lavé 600 fois à 90 C/194 F – Trois type de fils

MICRO SCRUB

Micro Scrub is ideal for both wet and dry cleaning. Especially on sticky floors. Cleaning and disinfecting takes place after the mop is presoaked with water mixed with diluted detergents

MICRO SCRUB

Le tampon "Micro Scrub" est idéal à la fois pour le nettoyage sec ou humide, spécialement sur les sols adhérents. Le nettoyage et la désinfection commence après que le tampon est pré-trempé dans de l'eau mélangée avec un détergents dilué.



EFM-FM6100-WH

Available in all colours
Ask your representative



| M2 Code Code M2 | Description | Pack Wt LB (S) Poids (lb) (S) | Pack Wt KG Poids (kg) | Cubic Ft Pi3 | Pack Contenu | List Price Liste des prix |
|--------------------|--|----------------------------------|--------------------------|-----------------|-----------------|------------------------------|
| EFM-FM5200 | Microfiber Treo Loop w/Tabs N/Pockets / Microfibre Treo Loop w/Tabs N/Pockets Rechange de tampon de microfibre "Treo Loop" avec attaches pas de pochette | 14.5 | 6.7 | | 10/1 | \$ 19.92 |
| EFM-FM54016 | Flat Mop Micro Scrub microfiber Pads refill 40cm/16" White/Green w/Tabs / Rechange de tampon microfibre pour vadrouille plate "Micro Scrub" 40cm/16" blanc/vert avec attaches | 15.4 | 7 | | 10/1 | \$ 14.14 |
| EFM-FM5200-T | Microfiber Treo Loop with T/Tabs / Rechange de tampon en microfibre "Treo Loop" avec attaches en T | | | | 10/1 | \$ 19.92 |
| EFM-FMT64516-T | Flat Mop MicroStrip MicroFiber Pad 40cm/16" white/w stripe With T/Tabs or Pockets / Tampon Velcro en microfibre pour vadrouille plate "MicroStrip" – 40cm/16" blanc/rayures | | | | 10/1 | \$ 18.32 |
| EFM-FMT64616-T | Flat Mop MicroLight MicroFiber Pad 40cm/16" white/w Blue stripe With T/Tabs or Pockets / Tampon Velcro en microfibre pour vadrouille plate "MicroStrip" 40cm/16" blanc/rayures | | | | 10/1 | \$ 14.03 |
| EFM-FMT64616-T | Flat Mop MicroLight MicroFiber Pad Refill 40cm/16" white/w Blue stripe With T/Tabs or Pockets / Tampon Velcro en microfibre pour vadrouille plate "MicroStrip" 40cm/16" blanc/rayures | | | | 10/1 | \$ 18.52 |
| EFM-FM6100-BL | Flat Mop Looped MicroTech fiber refill 40cm/16" Blue w/Tabs OR/Pockets / Recharge de vadrouille plate en microfibre bouclée 40cm/16" Bleu avec attaches | | | | 10/1 | \$ 18.82 |
| EFM-FM6100-RD | Flat Mop Looped MicroTech fiber refill 40cm/16" Red w/Tabs OR/Pockets / Recharge de vadrouille plate en microfibre bouclée 40cm/16" Rouge avec attaches | | | | 10/1 | \$ 18.82 |
| EFM-FM6100-YE | Flat Mop Looped MicroTech fiber refill 40cm/16" Yellow/Tabs OR/Pockets / Recharge de vadrouille plate en microfibre bouclée 40cm/16" Jaune avec attaches | | | | 10/1 | \$ 18.52 |
| EFM-FM6100-WH | Flat Mop Looped MicroTech fiber refill 40cm/16" White w/Tabs OR/Pockets / Recharge de vadrouille plate en microfibre bouclée 40cm/16" blanc avec attaches | | | | 10/1 | \$ 18.52 |
| EFM-FM6100-WH | Flat Mop Looped MicroTech fiber refill 40cm/16" White w/Tabs OR/Pockets / Recharge de vadrouille plate en microfibre bouclée 40cm/16" Blanc avec attaches | | | | 10/1 | \$ 16.50 |

DISPOSABLE MICROFIBER PADS

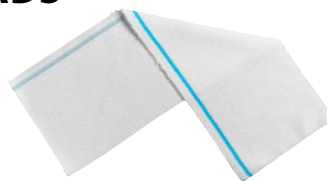

FLD-200

18" x 5" / 45 x 13 cm Disposable Healthcare Microfiber Pad

50/Bag
50 Bags/Box
500 Each
\$ 66.36

FLD-300

18" x 5" / 45 x 13 cm Disposable Microfiber Pad with Blue Scrub Stripe

50/Bag
50 Bags/Box
500 Each
\$ 37.58



ENTRY LEVEL FLAT MOPPING SYSTEM / SYSTÈME DE SEAU POUR VADROUILLE PLATE



Drain valve to release dirty water
Un drain de vidange pour libérer l'eau sale.

**COMPLETE -
ALL IN ONE BOX /
COMPLÈT - BOÎTE TOUT-
EN-UN**



16 QT/15 L / 16 PTES/15 L



1. Dip mop in clean water
2. Clean Floor

1. Tremper la vadrouille dans l'eau propre
2. Nettoyer le plancher



3. Dip in dirty water
4. Wring out

3. Tremper dans l'eau souillée
4. Essorer



4. Repeat / Répéter

- Double bucket is made with a unique Polypro material that has two compartments for clean and dirty water
- It is strong and long lasting and easier to keep clean
- Light weight and durable construction has 3" quiet rolling wheels
- Double bucket with wringer is light weight and easy to carry in and out of office or car
- Double bucket system ensures less cross-contamination as a result of using cleaner water longer

- Le seau double est fait d'un matériel de polypro unique et a deux compartiments pour l'eau propre et souillé.
- Il est robuste et durable et facile à garder propre.
- Il peut accommoder deux types d'essoreuse, l'essoreuse descendante jr. ou l'essoreuse à rouleaux.
- Le double seau avec essoreuse est léger et facile à transporter au bureau ou vers la voiture.
- Le système doubles seaux assure moins de contamination croisée, résultat de l'utilisation de l'eau propre plus longtemps.

| M2 Code Code M2 | Description | Pack Wt LB (S) Poids (lb) (S) | Pack Wt KG Poids (kg) | Cubic Ft PI3 | Pack Contenu | List Price Liste des prix |
|--------------------|---|----------------------------------|--------------------------|-----------------|-----------------|------------------------------|
| EFM-DB4510 | MicroFiber Starter Kit Inc. (Double Bucket w/Drain /w Speed Wringer Inc. frame handle and refill) / Trousse de départ - inclus, Seau double avec drain, essoreuse ("speed wringer"), châssis, manche et recharge de vadrouille plate | 12.5 | 5.6 | | 1 | \$ 349.35 |
| EFM-DB4500 | Double Bucket w/Drain /w Speed Wringer - Blue / Seau double avec drain et essoreuse ("Speed Wringer") - bleu | 6.7 | 3 | | 1 | \$ 290.08 |



**16 QT/15 L
16 PTES/15 L**

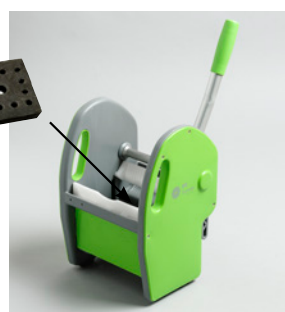

Double Buck

- Made with Polypro material with two compartments for clean and dirty water
- Can accommodate two types of wringers - Jr. Down Press or Roller Wringer
- Ensures less cross-contamination

Double seau 0.0125 in-

- Fabriqué avec un matériau polypropylène unique avec deux compartiments pour l'eau propre et sale.
- Peut accueillir deux types d'essoreuse - Descendante Jr. ou essoreuse à rouleaux.
- Assure moins de contamination croisée.

Roller Wringer

- Best for wringing out microfiber Spin-n-drop system
 - Light weight but strong construction
 - Roller with handle optimizes wringing efficiency
 - Fits both double bucket and single buckets
 - Consistent wringing action with less effort
- Essoreuse à rouleau**
- Le meilleur pour essorer les microfibrés du système "Spin n drop"
 - Elle est légère mais de construction robuste
 - Le rouleau et le manche optimisent l'efficacité de l'essorage
 - S'adapte aussi bien au seau double comme au seau simple
 - Très grande action d'essorage avec moins d'effort

M2 Jr. Down Press Wringer

- Can wring out Spin-n-drop mops with the Wringer Insert
 - Light weight but strong construction
 - Jaw pressure plates grab and force water into the bucket
 - Less force than traditional side press wringers
 - Fits both double bucket and single buckets
- L'essoreuse descendante M2 Jr.**
- Peut essorer les tampons "spin-n-drop" avec l'ajout de l'insertion
 - Légère mais de construction robuste
 - La mâchoire de la plaque de pression saisit et dirige l'eau dans le seau
 - Utilise moins de force qu'une essoreuse latérale traditionnelle
 - S'adapte aussi bien au seau double comme au seau simple

| | | | | | | |
|-------------------------|---|-----|-----|--|------|-----------|
| EFM-DB3500 | Double Bucket Only with Wheels Including Wringer Support - Green / Double seau seulement avec roues et support d'essoreuse - vert | | | | 1 | \$188.93 |
| EFM-RW3501 | Roller Wringer Only - Green / Essoreuse à rouleau seulement - vert | 7 | 3.2 | | 1 | \$ 267.68 |
| EFM-DP3510 | Jr Down Press Wringer Only - Green / Essoreuse descendante Jr. seulement - vert | 5.2 | 2.3 | | 1 | \$ 163.74 |
| EFM-DB3500 + EFM-RW3501 | Double Bucket Only with Wheels Including Wringer Support - Green and Roller Wringer Green / | | | | 1 | \$467.01 |
| EFM-DP3511 | Jr Down Press Wringer Insert / Insertion pour essoreuse descendante Jr. | .06 | .03 | | 10/1 | \$ 32.86 |

TOP DOWN CHARGING BUCKET TROLLEYS / CHARIOT DE SEAU - CHARGE DE HAUT EN BAS



EFM-PS-10000



EFM-PS-10010

- Made of strong resilient tubing that carries up to 3 mopboxes of any size
- Mop handle connector included
- Large durable wheels
- Fait de tube résilient robuste qui peut porter jusqu'à 3 baquets de pré-trempage de toutes tailles
- Connecteur de manche à vadrouille inclus
- Grandes roues durables

| M2 Code Code M2 | Description | Pack Wt LB (S) Poids (lb) (S) | Pack Wt KG Poids (kg) | Cubic Ft Pi³ | Pack Contenu | List Price Liste des prix |
|--------------------|--|----------------------------------|--------------------------|-----------------|-----------------|------------------------------|
| EFM-PS-10000 | PreSoak Trolley Only - Small / Petit chariot de pré-trempage seulement | 15.7 | 7.1 | | 1 | \$ 313.67 |
| EFM-PS-10010 | PreSoak Trolley Only - Medium/ Moyen chariot de pré-trempage seulement | | | | 1 | \$ 1,124.81 |

TOP DOWN PRESOAKING HERMETIC/CHARGING BUCKETS / BAQUETS DE PRÉ-TREMPAGE HERMÉTIQUES - CHARGE DE HAUT EN BAS

- Ideal for presoaking your microfiber pads for cleaning or disinfecting
- Buckets have a water tight lid to keep all mops moist and sealed
- Charging buckets have measuring marks in both litres and gallons
- A strong finger grip carrying handle to carry by hand or optional wheels for rolling

- Idéal pour pré-tremper les tampons de microfibre pour le nettoyage et la désinfection
- Les baquets ont un couverc étanche pour garder les tampons humide et scellés.
- Les baquets ont des marques de mesure en litres et en gallons.
- Une robuste poignée adhérente pour transporter manuellement ou en option des roues pour les rouler.

25 L / 6 US GALLON CAPACITY / CAPACITÉ
WATERTIGHT SEAL / JOINT ÉTANCHE À L'EAU



| M2 Code Code M2 | Description | Pack Wt LB (S) Poids (lb) (S) | Pack Wt KG Poids (kg) | Cubic Ft Pi³ | Pack Contenu | List Price Liste des prix |
|--------------------|---|----------------------------------|--------------------------|-----------------|-----------------|------------------------------|
| EFM-PS-10100-BL | Presoak Bucket - Blue / Seau de pré-trempage - bleu | 2.8 | 1.3 | | 10/1 | \$ 45.64 |
| EFM-PS-10101-BL | Presoak Bucket Lid - Blue / Couvercle pour seau de pré-trempage - bleu | 1.4 | .65 | | 10/1 | \$ 24.38 |
| EFM-PS-10102-RD | Presoak Bucket - Red / Seau de pré-trempage - rouge | 2.8 | 1.3 | | 10/1 | \$ 45.64 |
| EFM-PS-10103-RD | Presoak Bucket Lid- Red / Couvercle pour seau de pré-trempage - rouge | 1.4 | .65 | | 10/1 | \$ 24.38 |
| EFM-PS-10104 | Presoak Bucket Wheels Only (Set of 4) / Roues pour seau de pré-trempage seulement (pq de 4) | | | | 1 | \$ 27.20 |

STEPS TO CHARGE OR PRESOAK YOUR MOPPADS / ÉTAPE POUR CHARGER OU PRÉ-TEMPIER VOS TAMPONS



Step 1: Load 15-20 mops in the bucket
Étape 1: Charger les tampons dans le baquet



Step 2: Pour in the prepared solution
Étape 2: Insérer la solution préparée



Step 3: Close the lid
Étape 3: Fermer le couverc



Step 4: Flip the bucket to saturate the mops thoroughly
Étape 4: Renverser le baquet pour saturer les tampons complètement.



ACCESSORIES / ACCESSOIRES



| M2 Code Code M2 | Description | Pack Wt LB (S) Poids (lb) (S) | Pack Wt KG Poids (kg) | Cubic Ft Pi3 | Pack Contenu | List Price Liste des prix |
|--------------------|---|----------------------------------|--------------------------|-----------------|-----------------|------------------------------|
| EFM-PA1006-BL | 6L / 6.3 Qt Mini-Pour Pail - Blue / Mini-seau verseur 6L/6.3p - bleu | .7 | .3 | | 4/1 | \$ 20.24 |
| EFM-PA1006-GN | 6L / 6.3 Qt Mini-Pour Pail -Green / Mini-seau verseur 6L/6.3p - vert | .7 | .3 | | 4/1 | \$ 20.24 |
| EFM-PA1006-RD | 6L / 6.3 Qt Mini-Pour Pail - Red / Mini-seau verseur 6L/6.3p - rouge | .7 | .3 | | 4/1 | \$ 20.24 |
| EFM-PA1006-YE | 6L / 6.3 Qt Mini-Pour Pail - Yellow / Mini-seau verseur 6L/6.3p - jaune | .7 | .3 | | 4/1 | \$ 20.24 |



| M2 Code Code M2 | Description | Pack Wt LB (S) Poids (lb) (S) | Pack Wt KG Poids (kg) | Cubic Ft Pi3 | Pack Contenu | List Price Liste des prix |
|--------------------|--|----------------------------------|--------------------------|-----------------|-----------------|------------------------------|
| EFM-PA1006-Lid | 6L Mini-Pour Pail Lid Only / Couvercle pour mini-seau verseur 6L seulement | 1.5 | .7 | | 1 | \$ 17.80 |



FOODSERVICE SERVICE ALIMENTAIRE

FOOD PROCESSING / LA TRANSFORMATION DES ALIMENTS HACCP



HYGIENE PRODUCTS

M2 Professional Food Processing Products – are a range of products to satisfy the specific demands of food and professional hygiene processing.

M2 Professional Food Processing Product range is in compliance with the restricted standards set out by F.E.I.B.P. (European Brushware Federation), that meet the requirements of the following international standards:

- HACCP (Hazard Analysis of Critical Control Points) developed by the US Department of Agriculture. HACCP is a prevention-based system developed to help the food industry identify weak points or situations in order to prevent and/or reduce food contamination.
- EC Food Hygiene Directive (1993).
- US Public Health Service Food Code (1993).

PRODUITS D'HYGIÈNE

La gamme de produits de transformation des aliments de M2 Professional est conçu pour satisfaire les exigences spécifiques en matière d'hygiène dans l'industrie alimentaire et les secteurs professionnels.

La gamme de produits M2 Professional est en conformité avec les normes réglementées définies par F.E.I.B.P. (European Brushware Federation), qui répondent aux exigences des normes internationales suivantes:

- HACCP (Analyse des risques et maîtrise des points critiques) développé par le département américain de l'agriculture. HACCP est un système axé sur la prévention développés pour aider l'industrie alimentaire à identifier les points faibles ou des situation en vue de prévenir et/ou réduire la contamination des aliments.
- Directives de la CE sur l'hygiène alimentaire (1993)
- Code alimentaire du service de santé publique américain (1993)



SHIPPING / LIVRAISON

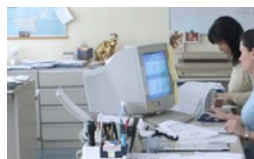

PACKAGING /
EMBALLAGE

HACCP COLOUR PROGRAM PROGRAMME DE COULEUR HACCP



WAREHOUSE / RECEIVING
ENTREPÔT / RÉCEPTION

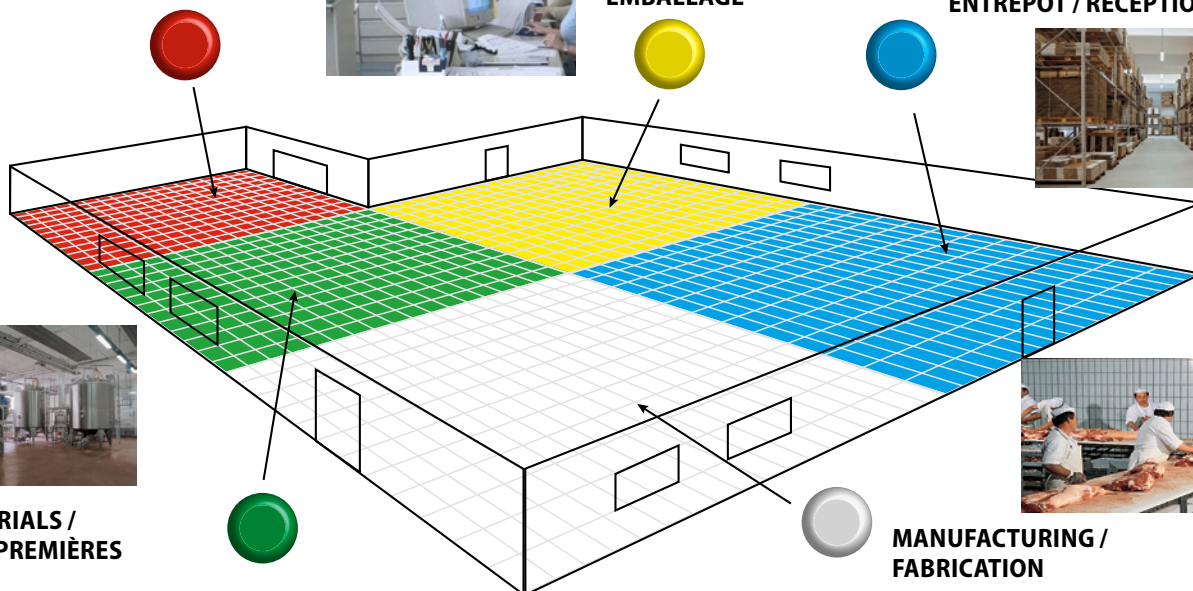

RAW MATERIALS /
MATIÈRES PREMIÈRES



MANUFACTURING /
FABRICATION



FOODSERVICE PUSHBROOMS & HANDLES BALAI-POUSSOIR D'ALIMENTATION ET MANCHES

Our unique pushbrooms are manufactured with highest quality fibers that are inset in an easy-to-clean and "wood-free" plastic block that resists bacteria to meet hygienic regulations.

Our Foodservice pushbrooms were designed for usage with many strong floor degreasers and for abrasive scrubbing.

- They can be washed to extend performance life.
- Colour coded to identify specific cleaning areas
- Takes a standard acme threaded handle

Nos balais-poussoir uniques sont fabriqués avec des fibres de haute qualité qui sont incrustées dans un format facile à nettoyer et un bloc en plastique sans bois qui résiste aux bactéries et respecte la réglementation en matière d'hygiène.

Nos balais-poussoir d'alimentation ont été conçus pour une utilisation avec de nombreux dégraissants de sol puissants et pour le nettoyage abrasif et peuvent être lavés pour prolonger la durée de la performance.

- Ils peuvent lavé pour prolonger la vie de la performance.
- Code de couleur pour identifier les domaines spécifiques de nettoyage.
- Utilise un manche fileté acmé standard



18"/45CM
24"/60CM

| M2 Code Code M2 | Description | Pack Wt LB (S) Poids (lb) (S) | Pack Wt KG Poids (kg) | Cubic Ft Pi3 | Pack Contenu | List Price Liste des prix |
|--------------------|---|----------------------------------|--------------------------|-----------------|-----------------|------------------------------|
| 18" / 45cm | | | | | | |
| PB-FS18-BK | Foodservice PushBroom 18" / 45 cm - Black / Balai-Poussoir d'alimentation 18" / 45 cm - noir | 18 | 8.3 | | 10/1 | \$ 25.22 |
| PB-FS18-WH | Foodservice PushBroom 18" / 45 cm - White / Balai-Poussoir d'alimentation 18" / 45 cm - blanc | 18 | 8.3 | | 10/1 | \$ 25.22 |
| PB-FS18-GN | Foodservice PushBroom 18" / 45 cm - Green / Balai-Poussoir d'alimentation 18" / 45 cm - vert | 18 | 8.3 | | 10/1 | \$ 25.22 |
| PB-FS18-BL | Foodservice PushBroom 18" / 45 cm - Blue / Balai-Poussoir d'alimentation 18" / 45 cm -bleu | 18 | 8.3 | | 10/1 | \$ 25.22 |
| PB-FS18-RD | Foodservice PushBroom 18" / 45 cm - Red / Balai-Poussoir d'alimentation 18" / 45 cm - rouge | 18 | 8.3 | | 10/1 | \$ 25.22 |
| PB-FS18-YE | Foodservice PushBroom 18" / 45 cm - Yellow / Balai-Poussoir d'alimentation 18" / 45 cm -jaune | 18 | 8.3 | | 10/1 | \$ 25.22 |
| 24" / 60cm | | | | | | |
| PB-FS24-BK | Foodservice PushBroom 24" / 60cm - Black / Balai-Poussoir d'alimentation 24" / 60cm - noir | 21 | 9.5 | | 10/1 | \$ 32.07 |
| PB-FS24-WH | Foodservice PushBroom 24" / 60cm - White / Balai-Poussoir d'alimentation 24" / 60cm - blanc | 21 | 9.5 | | 10/1 | \$ 32.07 |
| PB-FS24-GN | Foodservice PushBroom 24" / 60cm - Green / Balai-Poussoir d'alimentation 24" / 60cm - vert | 21 | 9.5 | | 10/1 | \$ 32.07 |
| PB-FS24-BL | Foodservice PushBroom 24" / 60cm - Blue / Balai-Poussoir d'alimentation 24" / 60cm - bleu | 21 | 9.5 | | 10/1 | \$ 32.07 |
| PB-FS24-RD | Foodservice PushBroom 24" / 60cm - Red / Balai-Poussoir d'alimentation 24" / 60cm - rouge | 21 | 9.5 | | 10/1 | \$ 32.07 |
| PB-FS24-YE | Foodservice PushBroom 24" / 60cm - Yellow / Balai-Poussoir d'alimentation 24" / 60cm - jaune | 21 | 9.5 | | 10/1 | \$ 32.07 |



FOODSERVICE TOOLHOLDER / PORTE-OUTILS D'ALIMENTATION

| M2 Code Code M2 | Description | Pack Wt LB (S) Poids (lb) (S) | Pack Wt KG Poids (kg) | Cubic Ft Pi3 | Pack Contenu | List Price Liste des prix |
|--------------------|--|----------------------------------|--------------------------|-----------------|-----------------|------------------------------|
| FP-TL9110 | 10" Aluminum Tool Holder/Hanger Blue, Red, Green, Yellow, White Porte-outils en aluminium 10" Bleu, rouge, vert, jaune, blanc | | | | 6/1 | \$ 22.04 |



FOODSERVICE FIBERGLASS HANDLES / MANCHES EN FIBRE DE VERRE POUR L'ALIMENTATION



COLOUR CODE SYSTEM
SYSTÈME DE CODE DE COULEUR

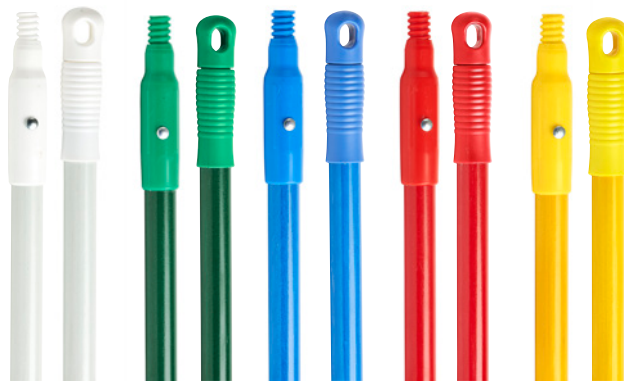

54" to 60" / De 54 à 60 po

| M2 Code Code M2 | Description | Pack Wt LB (S) Poids (lb) (S) | Pack Wt KG Poids (kg) | Cubic Ft Pi3 | Pack Contenu | List Price Liste des prix |
|--------------------|---|----------------------------------|--------------------------|-----------------|-----------------|------------------------------|
| FH-F354-BL | 54" / 137 cm Fiberglass Handle – Blue / Manche de fibre de verre, 54" / 137 cm, bleu | 14.5 | 6.7 | | 12/1 | \$ 19.02 |
| FH-F360-WH | 60" / 152 cm Fiberglass Handle – White / Manche de fibre de verre, 60" / 152 cm, blanc | 16.5 | 7.5 | | 12/1 | \$ 19.02 |
| FH-F360-GN | 60" / 152 cm Fiberglass Handle – Green / Manche de fibre de verre, 60" / 152 cm, vert | 16.5 | 7,5 | | 12/1 | \$ 19.02 |
| FH-F360-BL | 60" / 152 cm Fiberglass Handle – Blue / Manche de fibre de verre, 60" / 152 cm, bleu | 16.5 | 7.5 | | 12/1 | \$ 19.02 |
| FH-F360-RD | 60" / 152 cm Fiberglass Handle – Red / Manche de fibre de verre, 60" / 152 cm, rouge | 16.5 | 7,5 | | 12/1 | \$ 19.02 |
| FH-F360-YE | 60" / 152 cm Fiberglass Handle – Yellow / Manche de fibre de verre, 60" / 152 cm, jaune | 16.5 | 7.5 | | 12/1 | \$ 19.02 |

HYGIENIC MONOBLADE SQUEEGEES

Where hygiene is of utmost importance to the food industry, professional kitchen, hospital, labs and pharmaceutical industry

Approuvé par la
FDA
Approved

RACLETTE HYGIÉNIQUE MONO-LAME

Où l'hygiène est d'une importance primordiale: l'industrie alimentaire, les cuisines professionnelles, les hôpitaux, les laboratoires et l'industrie pharmaceutique.

- Optimal socket handle design
- Protected soft touch edges
- Ideal for smooth surfaces
- Autoclavable 138° C / 280° F
- One piece squeegee: no hidden bacteria
- High tear and wear resistance
- Use for floor and walls

- Conception optimale de la poignée
- Bords Tactiles protégés
- Idéal pour les surfaces lisses
- Stérilisation à la vapeur 138C/280F
- Raclette d'une seule pièce: pas de bactérie cachée
- Haute résistance aux déchirures et à l'usure
- Utilisez pour les planchers et les murs

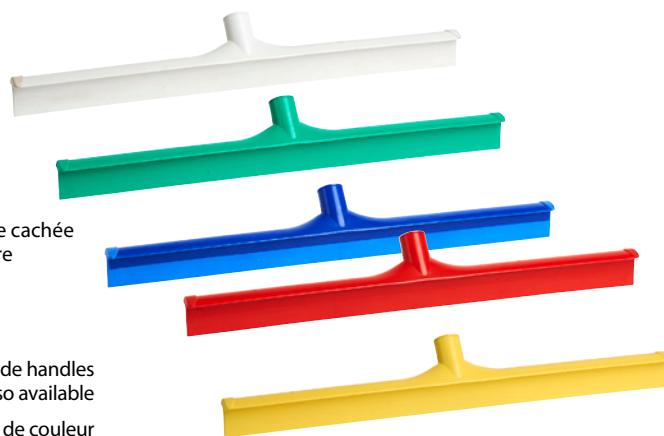

Colour code handles also available

Manches de couleur aussi disponibles

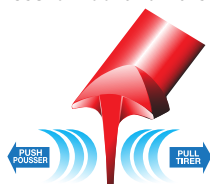

Smooth Water Flow /
Écoulement doux de l'eau

| M2 Code Code M2 | Description | Pack Wt LB (S) Poids (lb) (S) | Pack Wt KG Poids (kg) | Cubic Ft Pi3 | Pack Contenu | List Price Liste des prix |
|--------------------|---|----------------------------------|--------------------------|-----------------|-----------------|------------------------------|
| FS-MB220-WH | 20"/50 cm MonoBlade Floor Squeegee with Scraper - White / 20"/50 cm Raclette à plancher mono-lame avec racloir - blanc | | | | 6/1 | \$ 85.89 |
| FS-MB224-WH | 24"/60 cm MonoBlade Floor Squeegee with Scraper - White / 24"/60 cm Raclette à plancher mono-lame avec racloir - blanc | | | | 6/1 | \$ 113.52 |
| FS-MB224-GN | 24"/60 cm MonoBlade Floor Squeegee with Scraper - Green / 24"/60 cm Raclette à plancher mono-lame avec racloir - vert | | | | 6/1 | \$ 113.52 |
| FS-MB224-BL | 24"/60 cm MonoBlade Floor Squeegee with Scraper - Blue / 24"/60 cm Raclette à plancher mono-lame avec racloir -bleu | | | | 6/1 | \$ 113.52 |
| FS-MB224-RD | 24"/60 cm MonoBlade Floor Squeegee with Scraper - Red / 24"/60 cm Raclette à plancher mono-lame avec racloir - rouge | | | | 6/1 | \$ 113.52 |
| FS-MB224-YE | 24"/60 cm MonoBlade Floor Squeegee with Scraper - Yellow / 24"/60 cm Raclette à plancher mono-lame avec racloir - jaune | | | | 6/1 | \$ 113.52 |



BABY HIGH CHAIR & CHANGE TABLE

CHAISE HAUTE POUR BÉBÉ



| M2 Code Code M2 | Description | Pack Wt LB (S) Poids (lb) (S) | Pack Wt KG Poids (kg) | Cubic Ft Pi3 | Pack Contenu | List Price Liste des prix |
|--------------------|---|----------------------------------|--------------------------|-----------------|-----------------|------------------------------|
| HC-2900 | Baby High Chair - Grey / Chaise haute pour bébé - Gris | 12 | 5.5 | | 1 | \$ 303.64 |
| BCT-7818 | Baby changing table with liner dispenser - Wall mount / Table à langer avec distributrice de lingettes - montage mural | | | | 1 | \$ 706.12 |



| M2 Code Code M2 | Description | Pack Wt LB (S) Poids (lb) (S) | Pack Wt KG Poids (kg) | Cubic Ft Pi3 | Pack Contenu | List Price Liste des prix |
|--------------------|---|----------------------------------|--------------------------|-----------------|-----------------|------------------------------|
| BRP-210WS-WH | 9"/ 23 cm Short Handle Pot Brush - White Fiber / Pinceau à manche court 9 po/ 23 cm - fibre blanc | 5 | 2 | .5 | 12 | \$ 11.73 |
| BRP-210WS-GN | 9"/ 23 cm Short Handle Pot Brush - Green Fiber / Pinceau à manche court 9 po/ 23 cm - fibre vert | 5 | 2 | .5 | 12 | \$ 11.73 |
| BRP-210WS-BL | 9"/ 23 cm Short Handle Pot Brush - Blue Fiber / Pinceau à manche court 9 po/ 23 cm - fibre bleue | 5 | 2 | .5 | 12 | \$ 11.73 |
| BRP-210WS-RD | 5 9"/ 23 cm hort Handle Pot Brush Red Fiber / Pinceau à manche court 9 po/ 23 cm - fibre rouge | 5 | 2 | .5 | 12 | \$ 11.73 |
| BRP-210WS-YE | 9"/ 23 cm Short Handle Pot Brush - Yellow Fiber / Pinceau à manche court 9 po/ 23 cm - fibre jaune | 5 | 2 | .5 | 12 | \$ 11.73 |



| M2 Code Code M2 | Description | Pack Wt LB (S) Poids (lb) (S) | Pack Wt KG Poids (kg) | Cubic Ft Pi3 | Pack Contenu | List Price Liste des prix |
|--------------------|---|----------------------------------|--------------------------|-----------------|-----------------|------------------------------|
| BRP-210WL-WH | 20"/ 50 cm Long Handle Pot Brush - White Fiber / Brosse à pot de 20 po / 50 cm à manche long - fibre blanc | 9 | 4 | 1.2 | 6 | \$ 16.19 |
| BRP-210WL-GN | 20" Long Handle Pot Brush - Green Fiber / Brosse à pot de 20 po / 50 cm à manche long - fibre vert | 9 | 4 | 1.2 | 6 | \$ 16.19 |
| BRP-210WL-BL | 20" Long Handle Pot Brush - Blue Fiber / Brosse à pot de 20 po / 50 cm à manche long - fibre bleue | 9 | 4 | 1.2 | 6 | \$ 16.19 |
| BRP-210WL-RD | 20" Long Handle Pot Brush - Red Fiber / Brosse à pot de 20 po / 50 cm à manche long - fibre rouge | 9 | 4 | 1.2 | 6 | \$ 16.19 |
| BRP-210WL-YE | 20" Long Handle Pot Brush - Yellow Fiber / Brosse à pot de 20 po / 50 cm à manche long - fibre jaune | 9 | 4 | 1.2 | 6 | \$ 16.19 |

FOOD PROCESSING - PUSHBROOMS

HYGIENE FLOOR BROOM 18"/ 45 CM / BALAI À PLANCHER HYGIÉNIQUE 18"/ 45 CM

Push broom for cleaning floors and walls in the food industry and all those professional areas where hygiene is a priority. PBT fiber Medium.

Brosse à plancher idéale pour les planchers de ciment et les murs dans l'industrie alimentaire et de tous les secteurs professionnels où l'hygiène est une priorité. Fibres PBT à gros poils courts.



Please specify colour when ordering
S.v.p. spécifier la couleur au moment de la commande

- WH = B
- GN = V
- BL = BL
- RD = R
- YE = J

HYGIENE FLOOR BROOM 24"/ 60 CM / BALAI À PLANCHER HYGIÉNIQUE 24"/ 60 CM

Floor brush ideal for cleaning floors and walls in the food industry and all those professional areas where hygiene is a priority. PBT fiber Medium.

Brosse à plancher idéale pour les planchers de ciment et les murs dans l'industrie alimentaire et de tous les secteurs professionnels où l'hygiène est une priorité. Fibres PBT moyennes



| M2 Code Code M2 | Description | Pack Wt LB (S) Poids (lb) (S) | Pack Wt KG Poids (kg) | Cubic Ft Pi3 | Pack Contenu | List Price Liste des prix |
|--------------------|---|----------------------------------|--------------------------|-----------------|-----------------|------------------------------|
| FP-FB18M | Hygiene Floor Broom 18"/ 45 cm - Bristles Length 3.15"/ 80 mm / Balai à plancher hygiénique 18"/ 45 cm - Longueur 3.15"/ 80 mm | | | | 3/1 | \$ 100.89 |
| FP-FB24M | Hygiene Floor Broom 24"/ 60 cm - Bristles Length 3.15"/ 80 mm / Balai à plancher hygiénique 24"/ 60 cm - Longueur - 3.15"/ 80 mm | | | | 3/1 | \$ 142.45 |

FLOOR SCRUBBING BRUSH 12"/ 30 CM / BALAI-BROSSE À PLANCHER 12"/ 30 CM

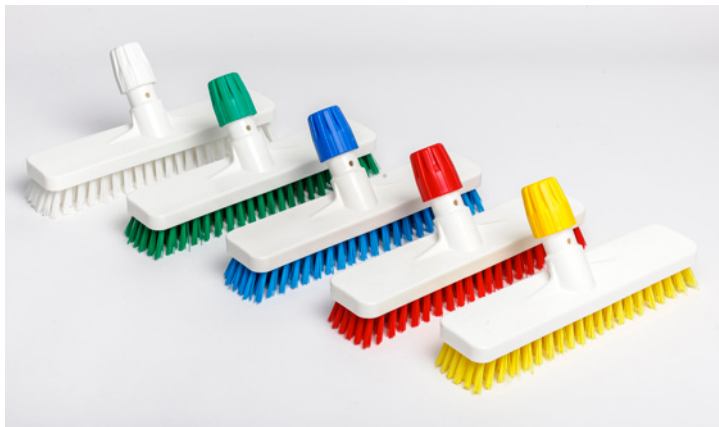

Floor brush ideal for scrubbing floors and walls in the food industry and all those professional areas where hygiene is a priority. PBT fiber Coarse Short Bristles.

Balai-poussoir pour les planchers de ciment et les murs dans l'industrie alimentaire et de tous les secteurs professionnels où l'hygiène est une priorité. Fibres PBT moyennes.

| M2 Code Code M2 | Description | Pack Wt LB (S) Poids (lb) (S) | Pack Wt KG Poids (kg) | Cubic Ft Pi3 | Pack Contenu | List Price Liste des prix |
|--------------------|---|----------------------------------|--------------------------|-----------------|-----------------|------------------------------|
| FP-FS12C | Floor Scrubbing Brush 12"/ 30 cm - Bristles Length - 1.10"/ 28 mm / Balai-brosse à plancher 12"/ 30 cm Longueur 1.10"/ 28 mm | | | | 4/1 | \$ 51.03 |



**UPRIGHT ANGLE BROOM 12"/ 30 CM /
BALAI À PLANCHER HYGIÉNIQUE – 12"/ 30 CM**

Upright Angle brushes are ideal for sweeping floors in the food industry and all those professional areas where hygiene is a priority. PBT fiber MEDIUM.
Balai droit en angle idéal pour nettoyer les planchers de ciment et les murs dans l'industrie alimentaire et tous les domaines professionnels où l'hygiène est une priorité. Fibres PBT moyennes.

**UPRIGHT BROOM SHORT FIBERS – 13"/ 33 CM /
BALAI EN ANGLE MONTANT 13"/ 33 CM**

Upright Brooms are ideal for cleaning floors in the food industry and all those professional areas where hygiene is a priority. PBT fiber MEDIUM.
Balai droit idéal pour le nettoyage des planchers de ciment et les murs dans l'industrie alimentaire et tous les domaines professionnels où l'hygiène est une priorité. Fibres PBT moyennes.

**SPECIFY COLOUR
WHEN ORDERING
SPÉCIFIER LA COULEUR LORS
DE LA COMMANDE**



| M2 Code Code M2 | Description | Pack Wt LB (S) Poids (lb) (S) | Pack Wt KG Poids (kg) | Cubic Ft Pi3 | Pack Contenu | List Price Liste des prix |
|--------------------|--|----------------------------------|--------------------------|-----------------|-----------------|------------------------------|
| FP-AB12C | Upright Angle Broom 12"/ 30 cm - Bristles Length – 4.53"/ 115 mm / Balai en angle montant 12"/ 30 cm Longueur – 4.53"/ 115 mm | | | | 8/1 | \$ 45.45 |
| FP-UB13C | Upright Broom Short Fibers 13"/ 33 cm - Bristles Length 2.95"/ 75mm / Balai en angle montant fibres courtes 13"/ 33 cm – Longueur 2.95"/ 75mm | | | | 10/1 | \$ 39.04 |

HANDLES / MANCHE

**ALUMINIUM HANDLE 54"/ 137 CM /
MANCHE ALUMINIUM 54"/137 CM/**

Aluminium handle with cap and European IT thread to fit all our items. Length 54"/137cm. diameter 1" / 23.5 mm, thickness 0,90 mm. Cap with loop available in 5 colour coded according to HACCP regulations.
Manche en aluminium avec crochet, fileté IT européen pour s'adapter à tous nos articles. Longueur 54 po/137cm, diamètre 1 po / 23.5 mm épaisseur 0.90 mm. Crochet avec boucle disponible dans 5 codes de couleur conformément à la réglementation HACCP.

**MONOBLOCK PLASTIC SHORT HANDLE – 24"/ 60 CM /
MANCHE COURT EN PLASTIQUE MONOBLOC 24"/ 60CM**

**MONOBLOCK PLASTIC LONG HANDLE - 57"/ 145 CM
MANCHE EN PLASTIQUE LONG MONOBLOC 57"/ 145 CM**

Handle made of plastic strengthened with Fiberglass, length 24"/60 cm., diameter from 22 to 32 mm., with European IT thread.
Manche en plastique renforcé avec fibre de verre, longueur 24 po /60 cm., diamètre de 22 à 32 mm., avec filetage IT européen.

**SPECIFY COLOUR
WHEN ORDERING
SPÉCIFIER LA COULEUR LORS
DE LA COMMANDE**



| M2 Code Code M2 | Description | Pack Wt LB (S) Poids (lb) (S) | Pack Wt KG Poids (kg) | Cubic Ft Pi3 | Pack Contenu | List Price Liste des prix |
|--------------------|---|----------------------------------|--------------------------|-----------------|-----------------|------------------------------|
| FP-AH54 | Aluminum Handle 54"/ 137 cm / 1"/ 25 mm Dia / Manche Aluminium 54"/137 cm / 1"/ 25 mm Diam. | | | | 10/1 | \$ 29.52 |
| FP-MB24 | MonoBlock Plastic Short Handle 24"/ 60 cm / Dia 1"/ 25mm/ Manche court en plastique monobloc 24"/ 60cm / Dim 1" 25 mm | | | | 10/1 | \$ 26.24 |
| FP-MB57 | MonoBlock Plastic Long Handle 57"/ 145 cm / Dia 1"/ 25 mm/ Manche en plastique long monobloc 57"/ 145 cm / Dim 1" /25 mm | | | | 10/1 | \$ 41.57 |

BRUSHES / BROSSSE

CYLINDER BRUSH 2.6"/ 65 MM / CYLINDER BRUSH 2.6"/ 65 MM

Ideal for cleaning pipes and tubes, meat mincers and for the fish-food industry. European IT thread allows fastening of a handle. PBT fiber available MEDIUM.

Idéal pour le nettoyage des tuyaux et des tubes, des hachoirs à viande et pour l'industrie alimentaire des poissons. Filetage IT européen, permet la fixation d'une poignée. Fibres PBT moyennes

Please specify colour when ordering
S.v.p. spécifier la couleur au moment de la commande



WH = B GN = V BL = BL RD = R YE = J



CYLINDER BRUSH 3.5"/ 90 MM / BROSSE À CYLINDRE 3.5"/ 90 MM

Ideal for cleaning pipes and tubes, meat mincers and for the fish-food industry. European IT thread allows fastening of a handle. PBT fiber available MEDIUM

CYLINDER BRUSH 4.7"/ 120 MM / BROSSE À CYLINDRE 4.7"/ 120 MM

Idéal pour le nettoyage des tuyaux et des tubes, des hachoirs à viande et pour l'industrie alimentaire des poissons. Filetage IT européen, permet la fixation d'une poignée. Fibres PBT moyennes

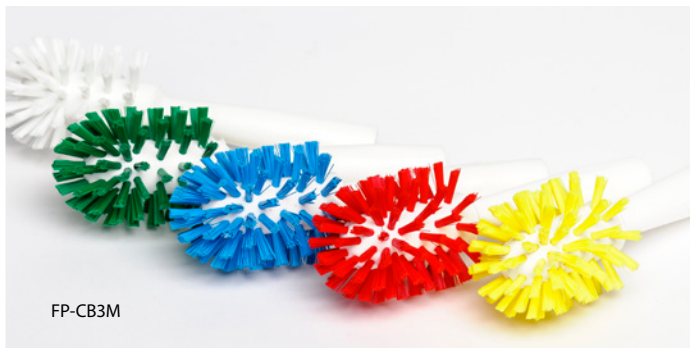

| M2 Code Code M2 | Description | Pack Wt LB (5) Poids (lb) (5) | Pack Wt KG Poids (kg) | Cubic Ft Pi3 | Pack Contenu | List Price Liste des prix |
|--------------------|---|----------------------------------|--------------------------|-----------------|-----------------|------------------------------|
| FP-CB2M | Cylinder Brush 2.6"/ 65 mm / Dia - Bristles Length 0.79"/ 20 mm / Brosse à cylindre 2.6"/ 65 mm / Diam Longueur 0.79"/ 20 mm | | | | 6/1 | \$ 22.48 |
| FP-CB3M | Cylinder Brush 3.5"/ 90 mm / Dia - Bristles Length 1.26"/ 32 mm / Brosse à cylindre 3.5"/ 90 mm / Diam Longueur 1.26"/ 32 mm | | | | 4/1 | \$ 25.48 |
| FP-CB4M | Cylinder Brush 4.7"/ 120 mm Dia.- Bristles Length 1.81"/ 46 mm / Brosse à cylindre 4.7"/ 120 mm / Dia Longueur 1.81"/ 46 mm | | | | 6/1 | \$ 26.90 |



**BANNISTER BRUSH LONG HANDLE – 15"/39 CM /
BROSSE POUR RAMPE À MANCHE LONG 15"/39 CM**

Suitable for cleaning workbenches, chopping boards, grating machines, machine parts, or other equipment for the food industry. PBT fiber Soft.

Convient pour le nettoyage des établis, planche à découper, machines à râper, pièces de machines, ou d'autres équipements pour l'industrie alimentaire. Fibres PBT douces.

**SCRUBBING BRUSH LONG HANDLE – 17"/44 CM /
BROSSE À RÉCURER MANCHE LONG – 17"/44 CM**

This long handle brush allows a safe approach to machine cleaning, reaching into deep containers and buckets, pipes and difficult recesses and corners. PBT fiber Medium.

Cette brosse à long manche permet une approche sûre pour le nettoyage d'une machine, pour atteindre les récipients profonds et les seaux, tuyaux et recoins et les coins difficiles. Fibres PBT moyennes.



| M2 Code Code M2 | Description | Pack Wt LB (S) Poids (lb) (S) | Pack Wt KG Poids (kg) | Cubic Ft Pi3 | Pack Contenu | List Price Liste des prix |
|--------------------|--|----------------------------------|--------------------------|-----------------|-----------------|------------------------------|
| FP-BB15S | Bannister Brush Long Handle 15"/39 cm - Bristle Length 2.17"/55 mm Brosse pour rampe à manche long 15"/39 cm - Longueur - 2.17"/55 mm | | | | 12/1 | \$ 31.55 |
| FP-SB17M | Scrubbing Brush Long handle 17"/44 cm - Bristles Length 1.77"/45 mm / Brosse à récurer manche long 17"/44 cm - Longueur 1.77"/45mm | | | | 12/1 | \$ 37.05 |

**TANK BRUSH - 9"/22 CM /
BROSSE DE RÉSERVOIR 9"/22 CM**

Ideal for cleaning tanks, cisterns, round containers. PBT fiber MEDIUM.

Idéal pour le nettoyage des réservoirs, citernes, contenants ronds. Fibres PBT moyennes disponibles.

**SPECIFY COLOUR
WHEN ORDERING
SPÉCIFIER LA COULEUR LORS
DE LA COMMANDE**



**POT/DETAIL BRUSH SHORT HANDLE – 10"/26 CM /
BROSSE À RÉCURER MANCHE COURT – 10"/26 CM**

Multi-purpose cleaning brush, suitable for cooking areas, food industry machinery and equipment, workbenches. PBT fiber Medium.

Brosse de nettoyage multi-usages, adapté aux domaines de cuisson, les machines de l'industrie alimentaire et de l'équipement, des établis. Fibres PBT moyennes.



FOOD PROCESSING BRUSHES THAT COME FROM EUROPE ALL HAVE THE EURO THREAD

This adapter will allow you to convert the brush to a locking collar

LES BROSSES DE CUISINE QUI PROVIENNENT D'EUROPE ONT TOUTES DES FILETS EUROPEENS.

Cet adaptateur vous permettra de convertir ces filets en un collier verrouillable.

| M2 Code Code M2 | Description | Pack Wt LB (S) Poids (lb) (S) | Pack Wt KG Poids (kg) | Cubic Ft Pi3 | Pack Contenu | List Price Liste des prix |
|--------------------|---|----------------------------------|--------------------------|-----------------|-----------------|------------------------------|
| FP-PB10M | Pot/Detail Brush Short Handle 10"/26 cm - Bristles Length 1.57"/40 mm / Brosse à récurer manche court 10"/26 cm - Longueur 1.57"/40 mm | | | | 4 | \$ 41.50 |
| FP-TB9C | Tank Brush 9"/22 cm - Bristles Length 1.57"/40 mm / Brosse de réservoir 9"/22 cm - bleu - Longueur 1.57"/40 mm | | | | 6 | \$ 85.21 |
| FH-A40 | Euro Adapter to a Cone Locking Collar / Adaptateur Euro/bague de blocage | | | | 1 | \$ 14.27 |

BRUSHES / BROSSE

NAIL BRUSH 4.5"/11.5 CM / BROSSE À ONGLES 4.5"/11.5 CM

Nail and hand brush with hanging loop. Also for cleaning small containers and machine parts. PBT fiber MEDIUM.

Brosse à main et ongles avec boucle de suspension. Également pour le nettoyage de petits récipients et pièces de machines. Fibres PBT douces et moyennes disponibles.

HAND SCRUB BRUSH 9"/23 CM / BROSSE À MAIN 9"/23 CM

Suitable for multi-purpose use in the food industry, for tanks, containers, workbenches, chopping boards, machine parts. PBT fiber, MEDIUM.

Convient pour une utilisation polyvalente dans l'industrie alimentaire, pour les citernes, conteneurs, établis, planches à découper, des pièces de machines. Fibres PBT moyennes et dures disponibles.

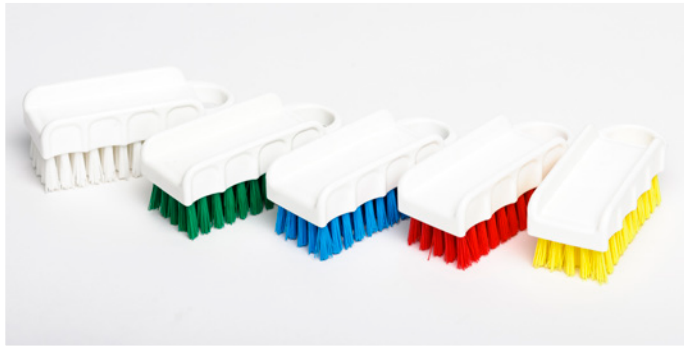

| M2 Code Code M2 | Description | Pack Wt LB (S) Poids (lb) (S) | Pack Wt KG Poids (kg) | Cubic Ft Pi3 | Pack Contenu | List Price Liste des prix |
|--------------------|--|----------------------------------|--------------------------|-----------------|-----------------|------------------------------|
| FP-NB4M | Nail Brush 4.5"/ 11.5 cm - Bristles Length 0.91"/23 mm / Brosse à ongles 4.5"/ 11.5 cm Longueur 0.91"/23 mm | | | | 12/1 | \$ 17.29 |
| FP-HS9M | Hand Scrub Brush 7"/ 17.8 cm - Bristles Length 1.06"/27 mm / Brosse à main 7"/ 17.8 cm Longueur 1.06"/ 27mm | | | | 6/1 | \$ 27.35 |



Please specify colour when ordering
S.v.p. spécifier la couleur au moment de la commande



WH = B GN = V BL = BL RD = R YE = J

3"/7.5 CM - STAINLESS STEEL SCRAPER

Multipurpose spatula 3" polypropylene handle and blade flexible. Made of stainless steel, 0.9 mm thick, suitable for removing particles stuck on hard surfaces.

3"/7.5 CM - GRATTOIR EN ACIER INOXYDABLE

Spatule à usage multiple de 3" avec poignée en polypropylène et lame flexible en acier inoxydable de 0,9 mm d'épaisseur, appropriées pour éliminer les particules collées sur des surfaces dures.

| M2 Code Code M2 | Description | Pack Wt LB (S) Poids (lb) (S) | Pack Wt KG Poids (kg) | Cubic Ft Pi3 | Pack Contenu | List Price Liste des prix |
|--------------------|--|----------------------------------|--------------------------|-----------------|-----------------|------------------------------|
| FP-SCR203 | 3"/ 7.5 cm -Stainless Steel Spatula - Thickness - 0.9 mm 3"/ .5 cm Spatule en acier inoxydable - épaisseur 0.9 mm | | | | 12/1 | \$ 19.55 |



5"/12.7 CM ROUND ERGONOMIC HAND SCRUB

Ergonomic Round Brush for cleaning small areas. Ideal for cleaning food containers. The design of this brush allows the user to push harder during use, achieving a more effective cleaning.

5"/12.7 CM BROSSE À MAIN RONDE ERGONOMIQUE

Brosse ronde ergonomique pour nettoyer les petites zones. Idéal pour le nettoyage des récipients de transport alimentaires.

La conception de cette brosse permet à l'utilisateur de pousser plus fort lors de l'utilisation pour réaliser un nettoyage plus efficace.

| M2 Code Code M2 | Description | Pack Wt LB (S) Poids (lb) (S) | Pack Wt KG Poids (kg) | Cubic Ft Pi3 | Pack Contenu | List Price Liste des prix |
|--------------------|--|----------------------------------|--------------------------|-----------------|-----------------|------------------------------|
| FP-HS4332-BL | 5"/ 12.7 cm Round Ergonomic Hand Scrub - Blue only - 1 3/4" x 44 mm / 5"/ 12.7 cm Brosse à main ronde ergonomique - bleu seulement - 1 3/4" x 44 mm | | | | 6/1 | \$ 18.79 |



TWISTED WIRE BRUSHES / BROSSE DE FIL TORSADÉ

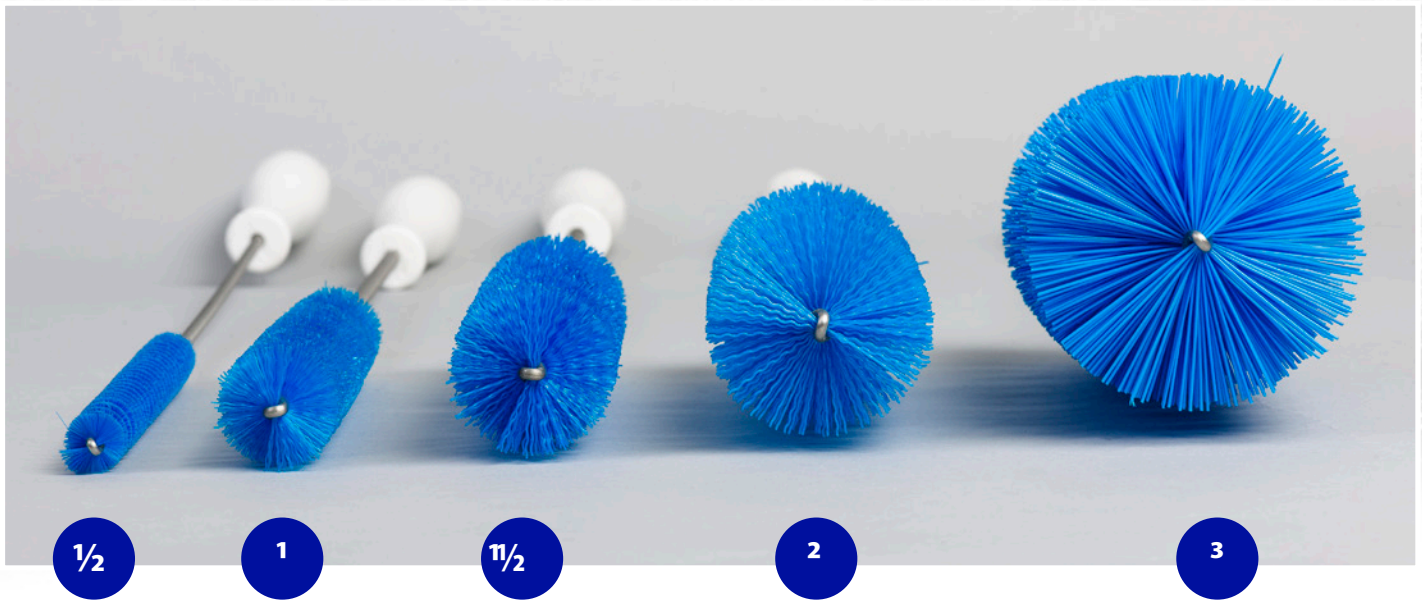

TWISTED WIRE BRUSHES AND ACCESSORIES BROSSES DE FIL TORSADÉ ET ACCESSOIRES

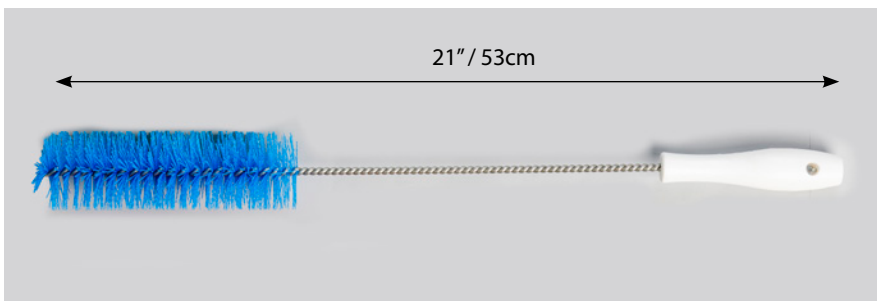

Please specify colour when ordering
S.v.p. spécifier la couleur au moment de la commande

WH=B GN=V BL=BL RD=R YE=J

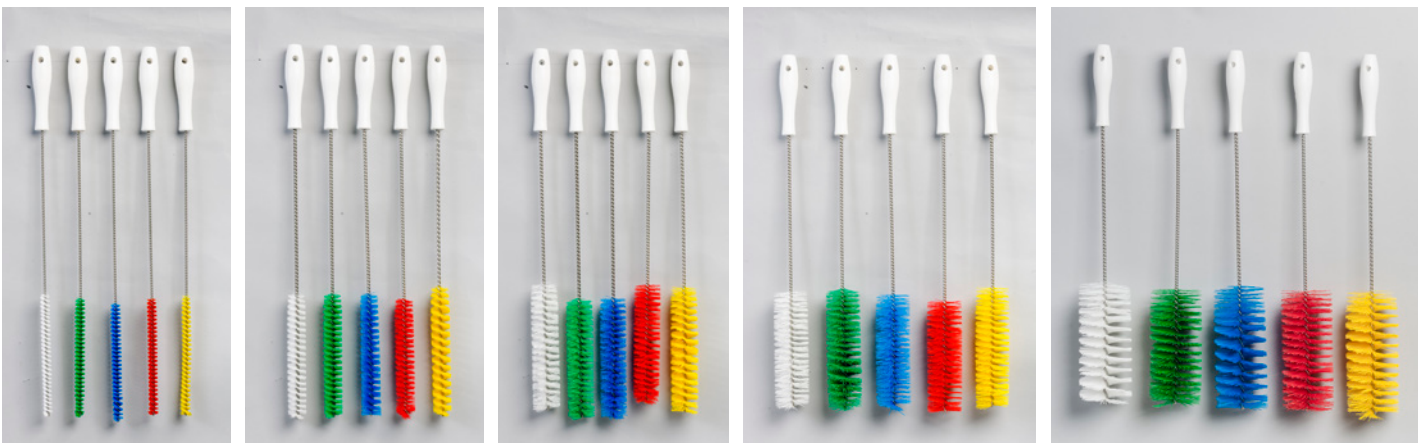

| M2 Code Code M2 | Description | Pack Wt LB (S) Poids (lb) (S) | Pack Wt KG Poids (kg) | Cubic Ft Pi3 | Pack Contenu | List Price Liste des prix |
|--------------------|---|----------------------------------|--------------------------|-----------------|-----------------|------------------------------|
| FP-TW5105 | 1/2" / 1.25 cm Twisted in Wire Brush / 1/2" / 1.25 cm Brosse de fil torsadé | | | | 6/1 | \$ 14.42 |
| FP-TW5110 | 1" / 2.25 cm Twisted in Wire Brush / 1" / 2.25 cm Brosse de fil torsadé | | | | 6/1 | \$ 18.38 |
| FP-TW5115 | 1 1/2" / 3.8 cm Twisted in Wire Brush / 1 1/2" / 3.8 cm Brosse de fil torsadé | | | | 6/1 | \$ 18.77 |
| FP-TW5120 | 2" / 5 cm Twisted in Wire Brush / 2" / 5 cm Brosse de fil torsadé | | | | 6/1 | \$ 18.87 |
| FP-TW5130 | 3" / 7.6 cm Twisted in Wire Brush / 3" / 7.6 cm Brosse de fil torsadé | | | | 6/1 | \$ 21.19 |

SPECIALTY FOOD SERVICE BRUSHES / BROSSES DE SPÉCIALITÉ POUR SERVICES ALIMENTAIRES



| M2 Code Code M2 | Description | Pack Wt LB (S) Poids (lb) (S) | Pack Wt KG Poids (kg) | Cubic Ft Pi3 | Pack Contenu | List Price Liste des prix |
|---|---|----------------------------------|--------------------------|-----------------|-----------------|------------------------------|
| 1" / 2.25CM TWISTED WIRE BRUSH FOR SNAKE / 1" / 2.25 CM Brosse de fil torsadé pour serpent | | | | | | |
| FP-TW5210 | 1" / 2.25 cm Twisted in Wire Brush for Snake -SS / 1" X 2.25 cm Brosse de fil torsadé pour serpent - SS | | | | 6/1 | \$ 26.51 |
| 2 1/2" / 6.3CM TWISTED WIRE BRUSH FOR SNAKE / 2 1/2" / 6.3 CM Brosse en fil torsadé pour serpent | | | | | | |
| FP-TW5225 | 2.5" / 6.3 cm Twisted in Wire Brush for Snake -SS / 2.5" / 6.3 cm Brosse en fil torsadé pour serpent - SS | | | | 6/1 | \$ 29.32 |
| STAINLESS STEEL SNAKE FOR TWISTED WIRE BRUSH / SERPENT POUR Brosse en fil torsadé acier inoxydable | | | | | | |
| FP-TW5280SS | Twisted Wire Snake Extension for Brush - 32.6" / 83 cm / extension de serpent pour brosse torsadé - 32.6" / 83 cm | | | | 6/1 | \$ 46.03 |
| HANDLE FOR TWISTED WIRE BRUSH / POIGNÉE POUR Brosse en fil torsadé | | | | | | |
| FP-TW5290 | Handle for Twisted Wire Snake / Poignée de serpent pour brosse en fil torsadé | | | | 6/1 | \$ 12.82 |

4" DRAIN BRUSH (WITHOUT HANDLE)

Brushes for cleaning drains in food processing facilities. Base made of solid polypropylene. Fibers made of PBT and takes a threaded handle.

4" Brosse à drain (sans poignée)

Brosse pour le nettoyage des drains dans les installations de transformation des aliments, à base de fibres de polypropylène solide PBT et noires, ces brosses acceptent une poignée filetée.

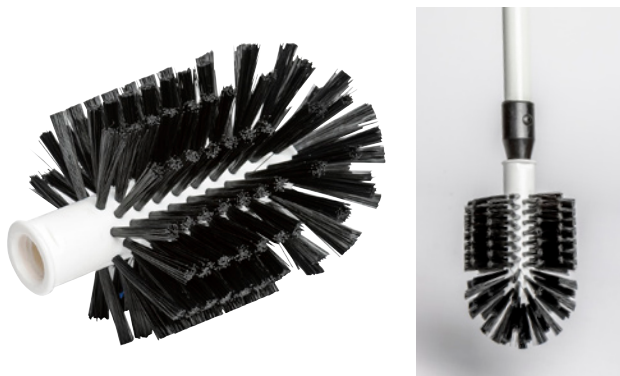

4" TUBE AND DRAIN BRUSH

Tube & drain brushes for meat grinders (also useful in cleaning valves and pipes), manufactured for food contact areas to ensure proper sanitation.

4" Brosse à tuyau et drain

Les brosses à tuyau et drain pour hachoirs à viande (aussi utiles pour nettoyer les vannes et tuyaux), fabriqués pour les zones de contact avec les aliments pour assurer la santé.



| M2 Code Code M2 | Description | Pack Wt LB (S) Poids (lb) (S) | Pack Wt KG Poids (kg) | Cubic Ft Pi3 | Pack Contenu | List Price Liste des prix |
|--------------------|--|----------------------------------|--------------------------|-----------------|-----------------|------------------------------|
| FP-DB5302-BK | 4" / 10 cm Drain Brush (Without Handle) / 4" / 10 cm Brosse à drain (sans poignée) | | | | 3/1 | \$ 20.71 |
| FP-DB5302-BL | 4" / 10 cm Tube and Drain Brush - Blue / 4" / 10 cm Brosse à tuyau et drain - bleu | | | | 4/1 | \$ 20.71 |
| FH-F360-WH | 60" / 152 cm Fiberglass Handle - White / Manche de fibre de verre, 60" / 152 cm, blanc | 16.5 | 7.5 | .5 | 12/1 | \$ 30.96 |



GLAZING BRUSHE / BROSSE À LUSTRER

2" / 5 CM GLAZING BRUSH

Glazing brushes with soft PBT 2" fiber in length and caliber of 0.006", widely used in the bakery industry and general food processing areas.

2" / 5 CM BROSSE À LUSTRER

Brosses à glacer avec fibres PBT de 2" de longueur et calibre 0,006", largement utilisées dans l'industrie de la boulangerie et dans les domaines de la restauration rapide.

Please specify colour when ordering
S.v.p. spécifier la couleur au moment de la commande

WH = B GN = V BL = BL RD = R YE = J

2" / 5 CM GLAZING BRUSH WITH HOOK

Glazing brushes with soft PBT 2" fiber in length and caliber of 0.006", widely used in the bakery industry and general fast food processing areas.

These brushes have a hook to hang on the edges of pots and Food containers helps to prevent leakage.

2" / 5 CM BROSSE À LUSTRER AVEC CROCHET

Brosse à lustrer avec une fibre douce PBT de 2" de longueur et de calibre 0,006", largement utilisé dans l'industrie de boulangerie et en général dans les domaines de la transformation des aliments.

Cette brosse a un crochet pour suspendre sur les bords des chaudrons et récipients alimentaires, aide à prévenir les fuites.



| M2 Code Code M2 | Description | Pack Wt LB (S) Poids (lb) (S) | Pack Wt KG Poids (kg) | Cubic Ft Pi3 | Pack Contenu | List Price Liste des prix |
|--------------------|---|----------------------------------|--------------------------|-----------------|-----------------|------------------------------|
| FP-GL5002 | 2" / 5 cm Glazing Brush / 2" / 5 cm Brosse à lustrer | | | | 12/1 | \$ 18.97 |
| FP-GL5002HK-WH | 2" / 5 cm Glazing Brush with Hook / 2" / 5 cm Brosse à lustrer avec crochet | | | | 12/1 | \$ 12.74 |

GRILL BRUSHES / BROSSES GRILLÉES LONG & SHORT HANDLE / POIGNÉE LONGUE ET COURTE



| M2 Code Code M2 | Description | Pack Wt LB (S) Poids (lb) (S) | Pack Wt KG Poids (kg) | Cubic Ft Pi3 | Pack Contenu | List Price Liste des prix |
|--------------------|--|----------------------------------|--------------------------|-----------------|-----------------|------------------------------|
| BBQ-1200 | 12"/30 cm BBQ Brush CC - Brass Bristles with Heavy Duty Scraper / 12"/30 cm Brosse a BBQ avec Poils en laiton inoxydable et grattoir robuste | 9 | 4.08 | .54 | 24 | \$ 4.46 |
| BBQ-1202 | 18"/45 cm Long Handle Ergo BBQ Brush with SS Bristles and Heavy Duty Scraper / 18"/45 po Brosse a BBQ manche long ergonomique de 18 pouces avec poils en acier inoxydable et grattoir robuste | 7 | 3.18 | 1.3 | 12 | \$ 9.52 |
| BBQ-1203 | Extra Large 2 Sided BBQ Brush with SS Bristles & Heavy Duty Scrub Pad and Scraper Brosses à BBQ à 2 côtés très grande - Poil en acier inoxydable et tampon récurant robuste | 7.2 | 3.27 | 1.5 | 12 | \$ 14.87 |

NATURAL GRILL BRUSHES / BROSSES NATURELLES DE GRIL



| M2 Code Code M2 | Description | Pack Wt LB (S) Poids (lb) (S) | Pack Wt KG Poids (kg) | Cubic Ft Pi3 | Pack Contenu | List Price Liste des prix |
|--------------------|--|----------------------------------|--------------------------|-----------------|-----------------|------------------------------|
| BBQ-W2200 | 20" / 50 cm Large Handle BBQ Brush w Scraper - Wood Block Bassine Fiber / Grande brosse de BBQ avec grattoir de 20 po et bloc en bois et fibre bassine | | | | 12 | \$ 30.87 |
| BBQ-W2201 | 20" / 50 cm Long Handle Wood Pot Brush w Natural Scraper-Bassine Fibre / Brosse en bois à manche long de 20 po avec grattoir en fibre naturelle bassine | | | | 12 | \$ 34.24 |
| BBQ-W2202 | 9 x 4" / 23 x 10 cm Wood Scrubbing Brush -Bassine Fiber / Brosse à récurer en bois 9"x 4"- fibre bassine | | | | 12 | \$ 34.24 |

SCOOPS / ÉCOPE

MINI HAND SCOOP 500 G / ML PELLE À MAIN MINI 500 G / ML

- Polypropylene hand scoop, from 500 g/mL capacity.
- Collect a variety of feed, flours, cereals and liquids



SMALL HAND SCOOP 1000 G / ML PELLE À MAIN PETITE 1000 G / ML

- Pelle à main en polypropylène, à partir de 500 g / ml de capacité
- Recueille une variété d'aliments pour animaux, des farines, des céréales et des liquides.



MEDIUM HAND SCOOP 1500 G / ML PELLE À MAIN MÉDIUM 1500 G / ML



-30 °C / -22 °F
+ 80 °C / 176 °F

| M2 Code Code M2 | Description | Pack Wt LB (S) Poids (lb) (S) | Pack Wt KG Poids (kg) | Cubic Ft Pi3 | Pack Contenu | List Price Liste des prix |
|--------------------|---|----------------------------------|--------------------------|-----------------|-----------------|------------------------------|
| FP-SC500-WH | Mini Hand Scoop - 500 g/mL capacity / Pelle à main mini - capacité 500 g/mL | | | | 1 | \$ 9.19 |
| FP-SC1000-WH | Small Hand Scoop 1000 g/mL capacity/ Pelle à main petite - capacité 1000 g/mL | | | | 1 | \$ 13.99 |
| FP-SC1500-WH | Medium Hand Scoop 1500 g/mL capacity/ Pelle à main médium - capacité 1500 g/mL | | | | 1 | \$ 34.71 |

LARGE HAND SCOOP 2000 G / ML PELLE À MAIN LARGE 2000 G / ML

- Polypropylene hand scoop, 2000 g/mL capacity.
- Collect a variety of feed, flours, cereals and liquids
- Pelle à main en polypropylène, capacité 2000g/mL
- Recueille une variété d'aliments pour animaux, des farines, des céréales et des liquides.



ROUND BOWL SCOOP 2000 G / ML PELLE EN BOL ROND 2000 G / ML

- POLYPROPYLENE Round Bowl Scoop 2000 g/mL capacity.
- Bol-cuillère rond en polypropylène, capacité 2000 g/mL



-30 °C / -22 °F
+ 80 °C / 176 °F

| M2 Code Code M2 | Description | Pack Wt LB (S) Poids (lb) (S) | Pack Wt KG Poids (kg) | Cubic Ft Pi3 | Pack Contenu | List Price Liste des prix |
|--------------------|--|----------------------------------|--------------------------|-----------------|-----------------|------------------------------|
| FP-SC2000-WH | Large Hand Scoop 2000 g/mL Capacity / Pelle à main large - capacité 2000 g/mL | | | | 1 | \$ 45.21 |
| FP-SC2L-WH | Round Bowl Scoop 2000 g/mL Capacity/ Pelle en bol rond - capacité 2000 g/mL | | | | 1 | \$ 45.77 |



SCRAPERS / GRATTOIRS

Our scrapers are designed for purpose and ease of use, without compromising strength and durability. The non-stick one piece scraper head is manufactured with both a square and round edged blade making it highly effective on a wide range of surfaces.

With no cracks or crevices, screws or rivets these tough and durable scrapers are virtually unbreakable and will not corrode or rust. Available in various colours to suit all colour coded requirements, the scrapers are an ideal product for hygiene applications.

Nos grattoirs sont conçus de façon à faciliter l'utilisation, sans compromettre la solidité ou la durabilité. La tête non collante du grattoir d'une seule pièce est fabriquée à la fois avec un carré et une lame ronde tranchante qui le rend très efficace sur une large gamme de surfaces.

En l'absence de fissures ou crevasses, de vis ou de rivets, ces grattoirs robustes et durables sont pratiquement incassables et ne seront pas corrodés ou rouillés. Disponibles en différentes couleurs pour s'adapter à toutes les exigences du code couleur, ces grattoirs sont un produit idéal pour les applications de l'hygiène.

SMALL HAND SCRAPER 3"/7.5 CM / GRATTOIR À MAIN PETIT 3"/7.5 CM

An invaluable product for removing various substances from flat surfaces such as work surfaces, table tops and conveyor belts. Polypropylene small scraper.

LARGE HAND SCRAPER 4"/10 CM / GRATTOIR À MAIN LARGE 4"/10 CM

Un produit précieux pour éliminer diverses substances sur des surfaces planes telles que les surfaces de travail, dessus de table et des courroies des convoyeurs. Petit grattoir en polypropylène, largeur

SMALL FLEXI-SCRAPER 6"/15 CM / GRATTOIR FLEXIBLE PETIT 6"/15 CM

Suitable for a variety of applications. Polypropylene small flexi scraper, 15 cm wide. Adapté pour diverses applications. Petit grattoir flexible en polypropylène, largeur 15 cm

LARGE FLEXI-SCRAPER 9"/23 CM / GRATTOIR FLEXIBLE GRAND 9"/23 CM

Suitable for a variety of applications. Polypropylene large flexi scraper, 23 cm wide. Adapté pour diverses applications. Large grattoir en polypropylène, largeur 23 cm

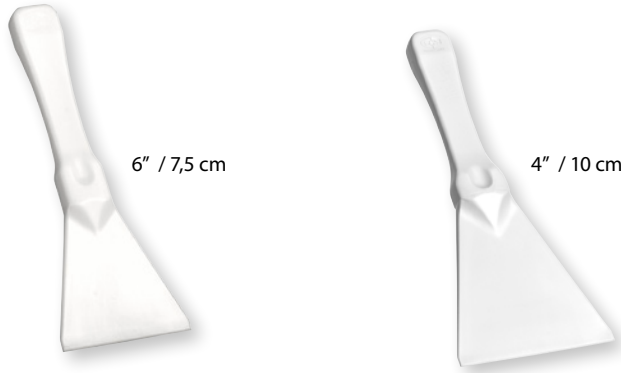

-30 °C / -22 ° F
+ 80 °C / 176 ° F

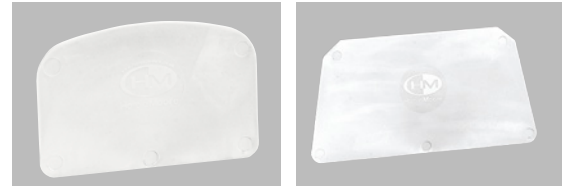

MULTI-PURPOSE SCRAPER BLADE - 10" X .24" / GRATTOIR À LAME DE NYLON TOUT-USAGE - 10" X .24"

HAND scraper with NYLON blade, 10" wide. Colour available: white.

FH-A36

MULTI-PURPOSE SCRAPER BLADE - STAINLESS STEEL 10" X .04" / 25 CM / GRATTOIR À LAME D'ACIER INOXYDABLE TOUT-USAGE - 10 X .04" / 25 CM

HAND scraper with STEEL blade, 10" wide. Colour available: white. Grattoir à main avec lame d'acier inoxydable, largeur 10 po Couleur disponible: blanc

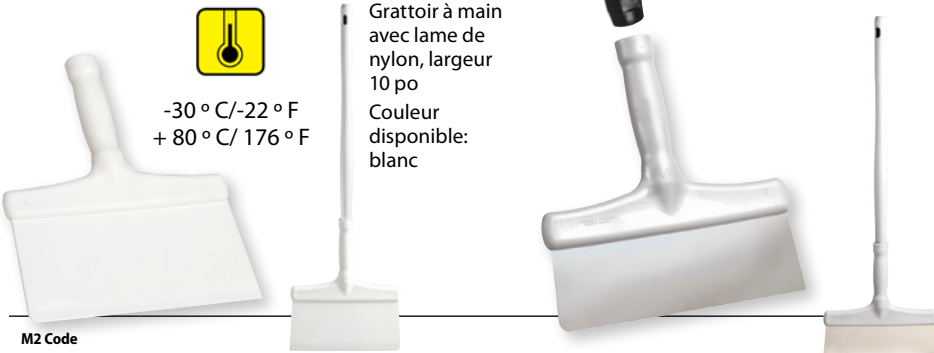

-30 °C / -22 ° F
+ 80 °C / 176 ° F

Grattoir à main avec lame de nylon, largeur 10 po
Couleur disponible: blanc

SPECIFY COLOUR WHEN ORDERING
SPÉCIFIER LA COULEUR LORS DE LA COMMANDE



| M2 Code Code M2 | Description | Pack Wt LB (S) Poids (lb) (S) | Pack Wt KG Poids (kg) | Cubic Ft Pi3 | Pack Contenu | List Price Liste des prix |
|--------------------|--|----------------------------------|--------------------------|-----------------|-----------------|------------------------------|
| FP-SCR811-WH | Small Hand Scraper 10/bag 3"/ 7.5 cm X 8"/ 20.5cm / Grattoir à main petit 10/sac 3"/ 7.5cm X 8"/ 20.5cm | | | | 10/1 | \$ 8.38 |
| FP-SCR812-WH | Large Hand Scraper 4"/ 10 cm X 10"/ 25.cm / Grattoir à main large 4"/ 10 cm X 10"/ 25.cm | | | | 10/1 | \$ 13.72 |
| FP-SCR813-WH | Small Flexi-scraper 6"/ 15 cm X 4"/ 3.82cm/ Grattoir flexible petit 6"/ 15 cm X 4"/ 3.82cm | | | | 10/1 | \$ 7.75 |
| FP-SCR814-WH | Large Flexi-scraper 9"/ 23 cm X 5"/ 11.8 cm/ Grattoir flexible grand 9"/ 23 cm X 5"/ 11.8 cm | | | | 10/1 | \$ 10.30 |
| FP-SCR110-WH | Multi-purpose Scraper Blade - Polypropylene 10 x .24 x 12" / 25 x .6 x 30 cm Grattoir à lame de polypropylène tout-usage 10 x .24 x 12 po/ 25 x .6 x 30 cm | | | | 10/1 | \$ 46.51 |
| FP-SCR111-WH | Multi-purpose Scraper Blade- Stainless Steel 10 x .24 x 12" / 25 x .6 x 30 cm Grattoir avec lame en acier inoxydable tout-usage 10 x .24 x 12 po/ 25 x .6 x 30 cm | | | | 10/1 | \$ 138.44 |
| FP-MB24 | MonoBlock Plastic Short Handle 24"/ 60 cm / Dia 1"/ 25mm/ Manche court en plastique monobloc 24"/ 60cm / Dim 1" 25 mm | | | | 10/1 | \$ 26.24 |
| FP-MB57 | MonoBlock Plastic Long Handle 57"/ 145 cm / Dia 1"/ 25 mm/ Manche en plastique long monobloc 57"/ 145 cm / Dim 1" /25 mm | | | | 10/1 | \$ 41.57 |
| FH-A36 | Threaded To Locking Collar adapters Adapteur de vissé | | | | 12/1 | \$ 2.33 |

SHOVELS / PELLES

STANDARD ONE PIECE SHOVEL 35 CM / 11" BLADE PELLE UNE PIÈCE STANDARD - 35 CM / 11"

POLYPROPYLENE ONE-PIECE SHOVEL,
Standard size (11 X 14 X 43" / 28 X 35 X 110 cm),
for food industry.

D-shaped hand grip. Pelle une pièce en polypropylène,
taille large (11 X 14 X 43" / 28 X 35 X 110 cm), pour
l'industrie alimentaire, poignée en forme de D

- Fits all HACCP system requirements
- Food contact certificates held
- Rust and rot-proof
- Tough and durable
- Non-stick
- Lightweight and easy to handle
- Virtually unbreakable

LARGE ONE PIECE SHOVEL 35 CM / 14" BLADE / PELLE UNE PIÈCE LARGE - 35 CM / 14" LARGEUR

Polypropylene One-Piece Shovel, Large size
(14 X 16 X 43" / 35 X 40 X 110 cm), for food industry. D-shaped hand grip.

Pelle une pièce en polypropylène, taille standard
(14 X 16 X 43 po / 35 X 40 X 110 cm), pour l'industrie alimentaire, poignée
en forme de D

- Convient à toutes les exigences du système HACCP
- Contact alimentaire certifié tenue
- Antirouille et imputrescible
- Robuste et durable
- Non collante
- Légère et facile à manipuler
- Pratiquement incassable



-30 °C / -22 °F
+ 80 °C / 176 °F

Please specify colour when ordering
S.v.p. spécifier la couleur au moment de la commande

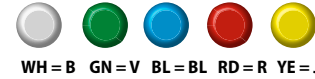

WH = B GN = V BL = BL RD = R YE = J



| M2 Code Code M2 | Description | Pack Wt LB (S) Poids (lb) (S) | Pack Wt KG Poids (kg) | Cubic Ft Pi3 | Pack Contenu | List Price Liste des prix |
|--------------------|--|----------------------------------|--------------------------|-----------------|-----------------|------------------------------|
| FP-SH11 | Standard One-piece Shovel-Blade Width -11"x 14"x 43" Oval Length (28 cm x 36 cm x 110 cm) Pelle une pièce standard - 11" / 35 cm Largeur de la lame / 43" longueur ovale | | | | 1 | \$ 227.49 |
| FP-SH14 | Large One-piece Shovel-Blade Width -14"x 16"x 43" Oval Length (35 cm x 40 cm x 110 cm) Pelle une pièce large - 14" / 35 cm largeur de la lame / 43" longueur ovale (35 cm x 40 cm x 110 cm) | | | | 1 | \$ 250.63 |

PADDLES / AGITATEURS

ONE PIECE PADDLE WITH HOLES / AGITATEUR SIMPLE D'UNE SEULE PIÈCE - AVEC TROUS

Single piece moulding in solid polypropylene suitable for temps - 30°C + 80°C.
Ideal for stirring viscous liquids. Polypropylene One Piece paddle with holes,
(5 x 12 x 46" / 12 x 29 x 119 cm).

Une seule pièce moulée en polypropylène solide, appropriée pour les
températures de - 30 C à + 80 C. Idéale pour l'agitation de liquides visqueux.
Agitateur une pièce en polypropylène avec trous, (5 x 12 x 46 po / 12 x 29 x 119 cm).



ONE PIECE PADDLE WITH WITHOUT HOLES / AGITATEUR SIMPLE D'UNE SEULE PIÈCE - SANS TROU



Paddle head range is available with an end cap as a hand tool
or with a stainless steel pole with hand grips.

- Fits all HACCP system requirements
- Food contact certificates held
- Lightweight and easy to handle
- Rot and rust-proof
- Tough and durable
- Non-stick
- Easily cleaned

Paddle head available in heat-resistant nylon (Black) with end cap or
with stainless steel pole and PP grips

La gamme de tête de l'agitateur est disponible avec un embout
comme un outil à main ou avec un manche en acier inoxydable
avec poignée.

- Convient à toutes les exigences du système HACCP
- Certificats de contact avec les aliments détenus
- Léger et facile à manipuler
- Imputrescible et antirouille
- Robuste et durable
- Non collant
- Facile à nettoyer

La tête de l'agitateur est disponible en nylon résistant à la chaleur (noir)
avec embout ou avec le manche en acier inoxydable et poignée PP.



-30 °C / -22 °F
+ 80 °C / 176 °F

| M2 Code Code M2 | Description | Pack Wt LB (S) Poids (lb) (S) | Pack Wt KG Poids (kg) | Cubic Ft Pi3 | Pack Contenu | List Price Liste des prix |
|--------------------|---|----------------------------------|--------------------------|-----------------|-----------------|------------------------------|
| FP-PD800-WH | Single One Piece Paddle- Ideal for stirring thick viscous liquids with Holes / 46" Overall Length Agitateur simple d'une seule pièce - idéal pour l'agitation de épais liquides visqueux - avec trous - 46" longueur ovale | | | | 1 | \$ 160.84 |
| FP-PD810-WH | Single One Piece Paddle- Ideal for stirring thin viscous liquids No Holes / 46" Overall Length Agitateur simple d'une seule pièce - idéal pour l'agitation de épais liquides visqueux - sans trou - 46" longueur ovale | | | | 1 | \$ 160.84 |



ICE BUCKETS, TOTES & DRAIN BOX / SEAU À GLACE, BACS UTILITAIRES ET BACS PERFORÉS



- 10 GALLON ICE BUCKET
10 GALLONS SEAU À GLACE**
- Ergonomic handle for easy gripping and reduced slippage
 - Countour lid for tote on tote stacking
 - Ice only logo printed on front
 - Weight: 2.25 lbs / 1 kg
 - Poignées ergonomiques pour une prise facile et réduire le glissement.
 - Contour de couvercle pour faciliter l'empilement.
 - Logo "Glace seulement" imprimé sur le devant.
 - Poids: 2.25 lbs / 1 kg



- 10 GALLON ICE BUCKET LID
10 COUVERCLE DE SEAU À GLACE**
- Ergonomic handle for easy gripping and reduced slippage
 - Countour lid for tote on tote stacking
 - Weight: .64 lbs / .3 kg
 - Poignées ergonomiques pour une prise facile et réduire le glissement.
 - Contour de couvercle pour faciliter l'empilement.
 - Poids: 0.64 lb / 0,3 kg



**4" / 10 CM BUS CUTLERY TOTE
4 PO/ 10 CM BUS BOX COUVERTS
FOURRE-TOUT**



**5" / 13 CM BUS TOTE
5 PO/ 13 CM BOÎTE BUS
FOURRE-TOUT**



**7" / 18 CM BUS TOTE
7 PO/ 18 CM BOÎTE BUS
FOURRE-TOUT**



**5" / 13 CM BUS TOTE LID
5 PO/ 13 CM BOÎTE BUS
FOURRE-TOUT COUVERCLE**



DRAIN BOX KIT INC. / L'ENSEMBLE DE BACS UTILITAIRES PERFORÉS INCLUS:

- 54 holes for fast easy draining / • 54 trous pour un drainage facile
- 1 - 21.25 x 11.25 x 7" / 54 x 29 x 18 cm - Bus Box / bac utilitaire
- 1 - 21.25 x 17.25 x 5" / 54 x 44 x 13 cm - Perforated Bus Box / bac utilitaire
- 1 - 21.25 x 11.25 x 1.5" / 54 x 29 x 4 cm Bus Box Lid - couvert de bac utilitaire



**BUS BOX
BAC UTILITAIRE**



**PERFORATED BUS BOX
BAC UTILITAIRE PERFORÉ**



**BUS BOX LID
COUVERT DE BAC UTILITAIRE**



| M2 Code Code M2 | Description | Pack Wt LB (S) Poids (lb) (S) | Pack Wt KG Poids (kg) | Cubic Ft Pi3 | Pack Contenu | List Price Liste des prix |
|--|---|----------------------------------|--------------------------|-----------------|-----------------|------------------------------|
| ICE BUCKETS / SEAU A GLACE | | | | | | |
| WM-PR1010-WH | 10 / 38 L Gallon Ice bucket - White / 10 gal / 38 L seau à glace - blanc | | | | 6/1 | \$ 43.31 |
| WM-PR1010-WH-L | 10 Gallon Ice Bucket Lid - White / 10 gallons couvercle de seau à glace - blanc | | | | 6/1 | \$ 26.27 |
| PP-7210 | Plastic Pail Lid Opener / Ouvre-couvercle de seau en plastique | | | | 12/1 | \$ 10.95 |
| BUS BOX TOTES / BUS FOURRE-TOUT | | | | | | |
| BB-4000 | 4" Bus Box Cutlery Tote - 13" x 21.5" x 4" H / 45 x 55 x 10 cm - Grey / 4" Bac à coutellerie 13" x 21" x 4" / 45 x 55 x 10 cm - gris | | | | 4/1 | \$ 23.38 |
| BB-5000 | 5" Bus Box Tote - 17.25" x 21.25" x 5" H / 45 x 55 x 13 cm - Grey / 5" Bac fourre-tout 17.25 x 21.25 . 5" / 45 x 55 x 13 cm - gris | | | | 4/1 | \$ 22.00 |
| BB-5001 | 5" Bus Box Tote Lid - 17.25" x 21.25" x 5" H / 45 x 55 x 13 cm - Grey / 5" Bac fourre-tout Couvercle 17.25 x 21.25 . 5" / 45 x 55 x 13 cm - gris | | | | 12/1 | \$ 26.46 |
| BB-7000 | 7" Bus Box Tote - 17.25" x 21.25" x 7" H / 45 x 55 x 18 cm - Grey / 7" Bac fourre-tout 17.25" x 21.25" x 7" / 45 x 55 x 18 cm - gris | | | | 4/1 | \$ 22.35 |
| BB-7050 | 7" X 5" / 18 x 13 cm Drain Box Kit Including Lid - White / 7" x 5" / 18 x 13 cm bac utilitaire perforé - blanc | | | | 1 | \$ 87.33 |

IN THE KITCHEN / BROSE À CHAUDRONS



| M2 Code Code M2 | Description | Pack Wt LB (S) Poids (lb) (S) | Pack Wt KG Poids (kg) | Cubic Ft Pi3 | Pack Contenu | List Price Liste des prix |
|--------------------|-------------------------------------|----------------------------------|--------------------------|-----------------|-----------------|------------------------------|
| RT-DB-9185 | Dish Brush / Brosse à vaisselle | | | | 48 | \$ 3.41 |
| RT-CB-9318 | Cookware Brush / Brosse à chaudrons | | | | 48 | \$ 3.84 |
| RT-DM-9217 | Dish Mop / Lavette à vaisselle | | | | 48 | \$ 3.60 |



| M2 Code Code M2 | Description | Pack Wt LB (S) Poids (lb) (S) | Pack Wt KG Poids (kg) | Cubic Ft Pi3 | Pack Contenu | List Price Liste des prix |
|--------------------|---|----------------------------------|--------------------------|-----------------|-----------------|------------------------------|
| RT-FB-9235 | Flexible Scrub Brush / Brosse à récurer flexible | | | | 48 | \$ 4.35 |
| RT-BB-9234 | Bottle Brush / Brosse à bouteille | | | | 48 | \$ 3.27 |
| RT-SD-9174 | Soap Dispensing Brush / Brosse distributrice de savon | | | | 48 | \$ 5.85 |



| M2 Code Code M2 | Description | Pack Wt LB (S) Poids (lb) (S) | Pack Wt KG Poids (kg) | Cubic Ft Pi3 | Pack Contenu | List Price Liste des prix |
|--------------------|---|----------------------------------|--------------------------|-----------------|-----------------|------------------------------|
| RT-SB9175 | Hand Grip Scrub Brush / Brosse à récurer manuelle | | | | 48 | \$ 5.57 |
| RT-GB-9196 | Tile Grout Brush / Brosse à coulis de carrelage | | | | 48 | \$ 2.95 |





| M2 Code Code M2 | Description | Pack Wt LB (S) Poids (lb) (S) | Pack Wt KG Poids (kg) | Cubic Ft Pi3 | Pack Contenu | List Price Liste des prix |
|--------------------|---|----------------------------------|--------------------------|-----------------|-----------------|------------------------------|
| RT-IB-9307 | Iron Brush / Brosse en fer | | | | 48 | \$ 5.15 |
| RT-NB-9319 | Nail Brush / Brosse à ongles | | | | 48 | \$ 3.04 |
| RT-MB-9237 | Magnetic Broom / Balai magnétique | | | | 6 | \$ 12.35 |
| RT-DB-9338 | Dustpan & Angle Broom / Balai en angle et porte-poussière | | | | 6 | \$ 17.31 |



| | | | | | | |
|------------|--|--|--|--|----|---------|
| RT-TB-9310 | Toilet Brush Only / Brosse à cuvette seulement | | | | 24 | \$ 6.69 |
| RT-TB-9311 | Toilet Brush and Cup / Brosse à cuvette seulement | | | | 12 | \$ 7.58 |
| RT-TB-9313 | Toilet Wire Brush / Brosse à cuvette torsadée | | | | 12 | \$ 5.38 |
| RT-TB-9314 | Toilet Brush Only/ Brosse à cuvette seulement | | | | 12 | \$ 6.50 |
| RT-TB-9315 | Toilet Brush with Lip and Cup/ Brosse à toilette avec brosse contour | | | | 12 | \$ 9.55 |



| | | | | | | |
|------------|--|---|---|-----|----|----------|
| BR-WM203 | Bowl Brush with Caddy - Poly Pro Bristles / Brosse à cuvettes avec porte-brosse, fibres de polypropylène | 8 | 4 | 1.6 | 24 | \$ 7.96 |
| BR-WM204 | Bowl Brush Only - | | | | 24 | \$ 5.25 |
| RT-WW-9312 | Window Wiper / Essuie-glace | | | | 48 | \$ 3.43 |
| RT-PL-9326 | Plunger / Brosse à cuvette avec côté | | | | 6 | \$ 5.15 |
| TB-96000 | Tub Scrubber with 48" Metal Handle / Épurateur pour baignoire - manche de métal blanc 48 po | | | | 12 | \$ 20.03 |

FLAT MOPPING / VADROUILLE PLATE



| M2 Code Code M2 | Description | Pack Wt LB (S) Poids (lb) (S) | Pack Wt KG Poids (kg) | Cubic Ft Pi3 | Pack Contenu | List Price Liste des prix |
|--------------------|---|----------------------------------|--------------------------|-----------------|-----------------|------------------------------|
| RT-FM-9250 | Flat Mop with Handle / Vadrouille plate avec manche | | | | 12 | \$ 33.55 |
| RT-FM-9251 | Flat Mop Refill Only / Rechange de vadrouille plate | | | | 12 | \$ 10.35 |

M2 CLEANING CENTRE DISPLAY / ÉTALAGE CENTRE DE NETTOYAGE M2



| M2 Code Code M2 | Description | Pack Contenu | List Price Liste des prix |
|--------------------|---|-----------------|------------------------------|
| CC-90001 | M2 Cleaning Centre Box - 32" x 25" x 22" / 81 x 63 x 56 cm / Boîte centre de nettoyage - 32 x 25 x 22 po / 81 x 63 x 56 cm | 1 | \$ 55.23 |
| CC-90002 | M2 Cleaning Centre Barrel - 24" x 78" / 56 x 96 cm / Baril centre de nettoyage - 24 x 78 po / 56 x 96 cm | 1 | \$ 79.69 |
| CC-90003 | Metal Broom Display | 1 | \$ 471.53 |

MISCELLANEOUS PRODUCTS / PRODUITS DIVERS



| M2 Code Code M2 | Description | Pack Wt LB (S) Poids (lb) (S) | Pack Wt KG Poids (kg) | Cubic Ft Pi3 | Pack Contenu | List Price Liste des prix |
|--------------------|---|----------------------------------|--------------------------|-----------------|----------------------------------|------------------------------|
| TM-600 | Garden Ties / Tomato Ties / Attaches de jardin / Attaches de tomates | | | | 12 | \$ 19.37 |
| CC-AC94000 | Universal Slot Wall & Peg Board Double Hook / Crochet double avec attache universel pour mur et tableau d'affichage | | | | | \$ 19.27 |
| MC-700BL | MicroScrunge-Microfiber all purpose Scrubber 8X12CM-3Pk/Hang-Up- 3EA/PK/12PACK/CSE | | | | 12/ 3 Pack Master 360Ea | \$ 18.64 |



Index

A

| | |
|-----------|----|
| AR-AP9204 | 92 |
| AR-FU9202 | 92 |
| AR-GL9200 | 92 |
| AR-OA9206 | 92 |
| AR-OV9205 | 92 |
| AR-ST9203 | 92 |

B

| | |
|--------------|--------|
| BA-3000 | 29 |
| BA-3001 | 29 |
| BA-3036 | 23, 28 |
| BA-3036-HO | 28 |
| BA-3200 | 27 |
| BA-3200-1W | 27 |
| BA-3220 | 27 |
| BA-3250 | 27 |
| BA-3250-2 | 27 |
| BA-8306-BK | 29 |
| BA-8306BK-48 | 29 |
| BA-8306-BL | 29 |
| BA-8306-GN | 29 |
| BA-8306-RD | 29 |
| BA-8306-YE | 29 |
| BA-9700 | 28 |
| BA-9700-D | 28 |
| BA-9700-HO | 28 |
| BA-9700-RD | 28 |
| BA-9708 | 28 |
| BA-9708-D | 28 |
| BA-9708-HO | 28 |
| BA-9708-RD | 28 |
| BA-9800 | 28 |
| BA-9900 | 28 |
| BB-410 | 43 |
| BB-3615 | 33 |
| BB-4000 | 138 |
| BB-5000 | 138 |
| BB-5001 | 138 |
| BB-7000 | 138 |
| BB-7050 | 138 |
| BBC-206GP | 35 |
| BBC-206M | 35 |

| | |
|--------------|-----|
| BBC-206SF | 35 |
| BBC-206T | 35 |
| BBQ-1200 | 134 |
| BBQ-1202 | 134 |
| BBQ-1203 | 134 |
| BBQ-W2200 | 134 |
| BBQ-W2201 | 134 |
| BBQ-W2202 | 134 |
| BC-101 | 30 |
| BC-102 | 30 |
| BC-103 | 30 |
| BC-104 | 30 |
| BC-107 | 30 |
| BC-107C | 30 |
| BC-108 | 30 |
| BC-110 | 30 |
| BC-500 | 30 |
| BCA-226WT | 31 |
| BCA-228P | 31 |
| BCA-228WT | 31 |
| BCT-7818 | 126 |
| BD-224UN | 33 |
| BD-226BA | 31 |
| BD-226BA-2 | 31 |
| BD-226PL | 31 |
| BD-1110 | 32 |
| BD-1110-M54 | 32 |
| BD-1508 | 32 |
| BD-1508-348W | 32 |
| BD-1608 | 32 |
| BD-1610 | 32 |
| BD-BD1601 | 32 |
| BD-BD1705 | 32 |
| BH-229PL | 31 |
| BH-229WT | 31 |
| BK-207L | 36 |
| BK-397L | 36 |
| BK-KW2027 | 36 |
| BK-KW2027-GN | 36 |
| BK-KW2027-GY | 36 |
| BK-KW2028 | 36 |
| BK-KW2029 | 36 |
| BM-4100 | 27 |
| BM-4200-BL | 26 |
| BM-4200-RD | 26 |
| BM-4200-W | 26 |
| BM-4250-BK | 26 |
| BM-4250-BL | 26 |

| | |
|---------------|---------|
| BM-4250-RD | 26 |
| BM-4260 | 26 |
| BM-4260-HO | 26 |
| BM-4261 | 26 |
| BM-4270 | 26 |
| BM-4300-BL | 26 |
| BM-4300-RD | 26 |
| BM-4320 | 26 |
| BM-4400 | 25 |
| BM-4400BK | 25 |
| BM-4400-HO | 25 |
| BM-4400-HO-RD | 25 |
| BM-4410 | 25 |
| BM-4420 | 25 |
| BM-4500 | 27 |
| BM-4500-BL | 27 |
| BM-4500-HO-BK | 25 |
| BM-4600-BL | 27 |
| BR-C0206D | 24 |
| BRP-210BFL | 35 |
| BRP-210BFS | 35 |
| BRP-210UNL | 35 |
| BRP-210WHT | 35 |
| BRP-210WL | 35 |
| BRP-210WL-BL | 126 |
| BRP-210WL-GFS | 35 |
| BRP-210WL-GN | 126 |
| BRP-210WL-RD | 126 |
| BRP-210WL-WH | 126 |
| BRP-210WL-YE | 126 |
| BRP-210WS | 35 |
| BRP-210WS-BL | 126 |
| BRP-210WS-GFS | 35 |
| BRP-210WS-GN | 126 |
| BRP-210WS-RD | 126 |
| BRP-210WS-WH | 126 |
| BRP-210WS-YE | 126 |
| BR-SC229 | 37 |
| BR-SC231 | 37 |
| BR-TR1253 | 32 |
| BR-UT1020 | 37 |
| BR-UT60306 | 37 |
| BR-UT60702 | 34 |
| BR-UT60709 | 34 |
| BR-WM202 | 93 |
| BR-WM203 | 93, 140 |
| BR-WM203-C | 93 |
| BR-WM204 | 93 |

| | |
|------------------|----|
| BR-WM214 | 94 |
| BT-112 | 29 |
| BT-112-NC | 29 |
| BT-113 | 29 |
| BT-115 | 29 |
| BV-298WH | 33 |
| BV-300AR | 33 |
| BV-300F | 33 |
| BV-301F | 33 |
| BV-400 | 34 |
| BV-400-BL | 34 |
| BV-400-GN | 34 |
| BV-400-RD | 34 |
| BV-400-WH | 34 |
| BV-400-YE | 34 |
| BV-420 | 34 |
| BV-421 | 34 |
| BV-3205 | 31 |
| BW-205SFR | 33 |
| BW-205WT | 33 |
| BW-205WTR | 33 |
| BW-1037 | 36 |
| BW-1038 | 36 |
| BW-1039 | 36 |
| BW-AC3310 | 6 |
| BW-D1232-40 - BL | 4 |
| BW-D1232-40 - BR | 4 |
| BW-D1232-40 - GY | 4 |
| BW-D1232-40 - YE | 4 |
| BW-D1232-BL | 6 |
| BW-D1232-BN | 6 |
| BW-D1232-GY | 6 |
| BW-D1232-YE | 6 |
| BW-D2632 - BL | 5 |
| BW-D2632 - BR | 5 |
| BW-D2632 - GY | 5 |
| BW-D2632 - YE | 5 |
| BW-D2633 - BL | 4 |
| BW-D2633 - BR | 4 |
| BW-D2633 - GY | 4 |
| BW-D2633 - YE | 4 |
| BW-D2640 - BL | 5 |
| BW-D2640 - BR | 5 |
| BW-D2640 - GY | 5 |
| BW-D2640 - YE | 5 |
| BW-D33101-BL | 6 |
| BW-D33101-GN | 6 |
| BW-D33101-GY | 6 |



| | | | | | | | |
|----------------|---|------------|-----|-----------------|----|--------------|----|
| BW-D33101-RD | 6 | CA-UT1900 | 14 | DF-SN560 | 83 | DM-MT518-BL | 78 |
| BW-D33101-YE | 6 | CA-UT1950 | 14 | DF-SN572 | 83 | DM-MT518-GN | 78 |
| BW-D41102 - BL | 5 | CC-90001 | 141 | DIS-8113 | 98 | DM-MT518-RD | 78 |
| BW-D41102 - GN | 5 | CC-90002 | 141 | DM-ALO518 | 84 | DM-MT518-YE | 78 |
| BW-D41102 - GY | 5 | CC-90003 | 141 | DM-ALO524 | 84 | DM-MT524-BL | 78 |
| BW-D41102 - RD | 5 | CC-90010 | 108 | DM-ALO536 | 84 | DM-MT524-GN | 78 |
| BW-D41102 -YE | 5 | CC-AC94000 | 141 | DM-ALO548 | 84 | DM-MT524-RD | 78 |
| BW-FU3500 | 7 | CL54 | 83 | DMBA-C518 | 81 | DM-MT524-YE | 78 |
| BW-S1011- BL | 7 | | | DMBA-C524 | 81 | DM-MT536-BL | 78 |
| BW-S1011 - YE | 7 | | | DMBA-C536 | 81 | DM-MT536-GN | 78 |
| BW-S1133 - BL | 4 | | | DMBA-C548 | 81 | DM-MT536-RD | 78 |
| BW-S1133 - BR | 4 | | | DMBA-GST53L6-BL | 80 | DM-MT536-YE | 78 |
| BW-S1133 - GY | 4 | | | DMBA-GST518L-BL | 80 | DM-MT548-BL | 78 |
| BW-S1133 - YE | 4 | | | DMBA-GST524L-BL | 80 | DM-MT548-GN | 78 |
| BW-S1140 - BL | 4 | | | DMBA-GST548L-BL | 80 | DM-MT548-RD | 78 |
| BW-S1140 - BR | 4 | | | DMBA-STH518-BL | 77 | DM-MT548-YE | 78 |
| BW-S1140 - GY | 4 | | | DMBA-STH524-BL | 77 | DM-MT560-BL | 78 |
| BW-S1140 - YE | 4 | | | DMBA-STH536-BL | 77 | DM-MT560-GN | 78 |
| BW-S26000 | 7 | | | DMBA-STH548-BL | 77 | DM-MT560-RD | 78 |
| BW-S32102 - BL | 5 | | | DM-C518 | 81 | DM-MT560-YE | 78 |
| BW-S32102 - GN | 5 | | | DM-C524 | 81 | DM-MT572-BL | 78 |
| BW-S32102 - GY | 5 | | | DM-C536 | 81 | DM-MT572-RD | 78 |
| BW-S32102 - RD | 5 | | | DM-C548 | 81 | DM-MT572-YE | 78 |
| BW-S32102 - YE | 5 | | | DM-C560 | 81 | DM-SC2999-2 | 84 |
| BW-S41000 | 7 | | | DM-C572 | 81 | DM-STH512-BL | 77 |
| BW-S42202-YE | 7 | | | DM-DP18 | 82 | DM-STH518-BL | 77 |
| BW-S73500-BL | 6 | | | DM-DP24 | 82 | DM-STH518-GN | 77 |
| BW-S73500-GN | 6 | | | DM-DP36 | 82 | DM-STH518-RD | 77 |
| BW-S73500-GY | 6 | | | DM-DP48 | 82 | DM-STH524-BL | 77 |
| BW-S73500-RD | 6 | | | DM-DP60 | 82 | DM-STH524-GN | 77 |
| BW-S73500-YE | 6 | | | DM-DP72 | 82 | DM-STH524-RD | 77 |
| | | | | DM-GST518-BL | 80 | DM-STH536-BL | 77 |
| | | | | DM-GST518-L-BL | 80 | DM-STH536-GN | 77 |
| | | | | DM-GST524-BL | 80 | DM-STH536-RD | 77 |
| | | | | DM-GST524-L-BL | 80 | DM-STH548-BL | 77 |
| | | | | DM-GST536-BL | 80 | DM-STH548-GN | 77 |
| | | | | DM-GST536-L-BL | 80 | DM-STH548-RD | 77 |
| | | | | DM-GST548-BL | 80 | DM-STH560-BL | 77 |
| | | | | DM-GST548-L-BL | 80 | DM-STH572-BL | 77 |
| | | | | DM-H1216 | 84 | DM-T518 | 79 |
| | | | | DM-H1216F | 84 | DM-T524 | 79 |
| | | | | DM-H1216R | 84 | DM-T536 | 79 |
| | | | | DM-MPE518 | 79 | DM-T548 | 79 |
| | | | | DM-MPE524 | 79 | DM-VE518-BL | 81 |
| | | | | DM-MPE536 | 79 | DM-VE524-BL | 81 |
| | | | | DM-MPE548 | 79 | DM-VE536-BL | 81 |
| | | | | DM-MPE560 | 79 | DM-VE548-BL | 81 |
| | | | | DM-MPE572 | 79 | DM-W518 | 69 |

D

C

| | |
|-----------|----|
| CA-CT4900 | 13 |
| CA-HK5813 | 13 |
| CA-HS4800 | 13 |
| CA-HS4801 | 13 |
| CA-M1000 | 11 |
| CA-M1001 | 11 |
| CA-M1800 | 13 |
| CA-M1801 | 13 |
| CA-M2000 | 11 |
| CA-M2001 | 11 |
| CA-M2200 | 12 |
| CA-UT1840 | 14 |
| CA-UT1850 | 14 |
| CA-UT1860 | 14 |

| | |
|---------------------|----|
| DB-8216 | 8 |
| DF-CL54-F | 83 |
| DF-CL60 | 83 |
| DF-CL60-A | 83 |
| DF-CL60-Ext | 83 |
| DF-CL60-F | 83 |
| DF-CL60-F-Colour | 83 |
| DF-CL60-M | 83 |
| DF-CL518 | 83 |
| DF-CL524 | 83 |
| DF-CL536 | 83 |
| DF-CL548 | 83 |
| DF-CL560 | 83 |
| DF-CL572 | 83 |
| DF-EZY60 | 84 |
| DF-EZY60-AL | 84 |
| DF-EZY60-EXT | 84 |
| DF-EZY60F - Colours | 84 |
| DF-EZY518 | 84 |
| DF-EZY518-H | 84 |
| DF-EZY524 | 84 |
| DF-EZY524-H | 84 |
| DF-EZY536 | 84 |
| DF-EZY536-H | 84 |
| DF-EZY548 | 84 |
| DF-EZY548-H | 84 |
| DF-SC2999FH | 84 |
| DF-SN60-A | 83 |
| DF-SN60-EXT | 83 |
| DF-SN60-F | 83 |
| DF-SN60-F - Colour | 83 |
| DF-SN60-M | 83 |
| DF-SN60-W | 83 |
| DF-SN518 | 83 |
| DF-SN524 | 83 |
| DF-SN536 | 83 |
| DF-SN548 | 83 |

| | |
|-----------------|----|
| DF-SN560 | 83 |
| DF-SN572 | 83 |
| DIS-8113 | 98 |
| DM-ALO518 | 84 |
| DM-ALO524 | 84 |
| DM-ALO536 | 84 |
| DM-ALO548 | 84 |
| DMBA-C518 | 81 |
| DMBA-C524 | 81 |
| DMBA-C536 | 81 |
| DMBA-C548 | 81 |
| DMBA-GST53L6-BL | 80 |
| DMBA-GST518L-BL | 80 |
| DMBA-GST524L-BL | 80 |
| DMBA-GST548L-BL | 80 |
| DMBA-STH518-BL | 77 |
| DMBA-STH524-BL | 77 |
| DMBA-STH536-BL | 77 |
| DMBA-STH548-BL | 77 |
| DM-C518 | 81 |
| DM-C524 | 81 |
| DM-C536 | 81 |
| DM-C548 | 81 |
| DM-C560 | 81 |
| DM-C572 | 81 |
| DM-DP18 | 82 |
| DM-DP24 | 82 |
| DM-DP36 | 82 |
| DM-DP48 | 82 |
| DM-DP60 | 82 |
| DM-DP72 | 82 |
| DM-GST518-BL | 80 |
| DM-GST518-L-BL | 80 |
| DM-GST524-BL | 80 |
| DM-GST524-L-BL | 80 |
| DM-GST536-BL | 80 |
| DM-GST536-L-BL | 80 |
| DM-GST548-BL | 80 |
| DM-GST548-L-BL | 80 |
| DM-H1216 | 84 |
| DM-H1216F | 84 |
| DM-H1216R | 84 |
| DM-MPE518 | 79 |
| DM-MPE524 | 79 |
| DM-MPE536 | 79 |
| DM-MPE548 | 79 |
| DM-MPE560 | 79 |
| DM-MPE572 | 79 |

| | |
|--------------|----|
| DM-MT518-BL | 78 |
| DM-MT518-GN | 78 |
| DM-MT518-RD | 78 |
| DM-MT518-YE | 78 |
| DM-MT524-BL | 78 |
| DM-MT524-GN | 78 |
| DM-MT524-RD | 78 |
| DM-MT524-YE | 78 |
| DM-MT536-BL | 78 |
| DM-MT536-GN | 78 |
| DM-MT536-RD | 78 |
| DM-MT536-YE | 78 |
| DM-MT548-BL | 78 |
| DM-MT548-GN | 78 |
| DM-MT548-RD | 78 |
| DM-MT548-YE | 78 |
| DM-MT560-BL | 78 |
| DM-MT560-GN | 78 |
| DM-MT560-RD | 78 |
| DM-MT560-YE | 78 |
| DM-MT572-BL | 78 |
| DM-MT572-RD | 78 |
| DM-MT572-YE | 78 |
| DM-SC2999-2 | 84 |
| DM-STH512-BL | 77 |
| DM-STH518-BL | 77 |
| DM-STH518-GN | 77 |
| DM-STH518-RD | 77 |
| DM-STH524-BL | 77 |
| DM-STH524-GN | 77 |
| DM-STH524-RD | 77 |
| DM-STH536-BL | 77 |
| DM-STH536-GN | 77 |
| DM-STH536-RD | 77 |
| DM-STH548-BL | 77 |
| DM-STH548-GN | 77 |
| DM-STH548-RD | 77 |
| DM-STH560-BL | 77 |
| DM-STH572-BL | 77 |
| DM-T518 | 79 |
| DM-T524 | 79 |
| DM-T536 | 79 |
| DM-T548 | 79 |
| DM-VE518-BL | 81 |
| DM-VE524-BL | 81 |
| DM-VE536-BL | 81 |
| DM-VE548-BL | 81 |
| DM-W518 | 69 |



| | | | | | | | |
|------------|-----|-----------------|--------------|------------------|----------------|----------------|----------|
| DM-WV516 | 116 | EFM-FM6100-BL | 119 | FH-F354NT1516-BL | 49 | FP-AH54 | 128 |
| DM-WV518 | 69 | EFM-FM6100-RD | 119 | FH-F354NT1516-BL | 52 | FP-BB15S | 130 |
| DP-H509 | 24 | EFM-FM6100-WH | 119 | FH-F354-WH | 49 | FP-CB2M | 129 |
| DP-H509-BB | 24 | EFM-FM6100-YE | 119 | FH-F360-BL | 49, 125 | FP-CB3M | 129 |
| DP-H514-BK | 24 | EFM-FM54016 | 119 | FH-F360-GN | 49, 125 | FP-CB4M | 129 |
| DP-H614 | 24 | EFM-FM64410 | 111 | FH-F360NT1516-BL | 49 | FP-DB5302-BK | 133 |
| DP-H715 | 24 | EFM-FMT64516-T | 119 | FH-F360NT-BL | 49 | FP-DB5302-BL | 133 |
| DP-H716 | 24 | EFM-FMT64616 | 119 | FH-F360-OR | 49 | FP-FB18M | 127 |
| DP-L700 | 23 | EFM-FMT64616-T | 119 | FH-F360-RD | 49, 125 | FP-FB24M | 127 |
| DP-L800 | 23 | EFM-FMV64510 | 110 | FH-F360-WH | 49, 125, 133 | FP-FS12C | 127 |
| DP-L800-CH | 23 | EFM-FMV64516 | 110 | FH-F360-YE | 125 | FP-GL5002 | 134 |
| DP-L800-PL | 23 | EFM-FMV64518 | 110 | FH-F360-YL | 49 | FP-GL5002HK-WH | 134 |
| DP-L802 | 23 | EFM-FMV64524 | 110 | FH-M336 | 48 | FP-HS9M | 131 |
| DP-L810 | 23 | EFM-FMV64540 | 110 | FH-M336-2 | 48 | FP-HS4012-BL | 34 |
| DP-L830 | 23 | EFM-FMV64710 | 111 | FH-M348 | 48 | FP-HS4022-BL | 34 |
| DP-L831 | 23 | EFM-PA1006-BL | 122 | FH-M348-3 | 48 | FP-HS4332-BL | 34, 131 |
| DP-L950 | 23 | EFM-PA1006-GN | 122 | FH-M348-BK | 48 | FP-HS4500-BL | 34 |
| DU-F1224 | 87 | EFM-PA1006-Lid | 122 | FH-M348-EU-BL | 48 | FP-MB24 | 128, 136 |
| DU-L524 | 87 | EFM-PA1006-RD | 122 | FH-M348HD-BK | 48 | FP-MB57 | 128, 136 |
| DU-L524-2 | 87 | EFM-PA1006-YE | 122 | FH-M348HD-BL | 48 | FP-NB4M | 131 |
| DU-L525 | 87 | EFM-PA1015-BL | 8 | FH-M348-RD | 48 | FP-PA8502 | 37 |
| DU-L525-2 | 87 | EFM-PA1015-RD | 8 | FH-M354HD-BK | 48 | FP-PB10M | 130 |
| DU-L527 | 87 | EFM-PS-10000 | 121 | FH-M360 | 48 | FP-PD800-WH | 137 |
| DU-L528 | 87 | EFM-PS-10010 | 121 | FH-M360-BK | 43, 48 | FP-PD810-WH | 137 |
| DU-M8500 | 86 | EFM-PS-10100-BL | 10, 106, 121 | FH-M378 | 48 | FP-SB17M | 130 |
| DU-M8501 | 86 | EFM-PS-10101-BL | 10, 106, 121 | FH-M2354-HDBK | 48 | FP-SC2L-WH | 135 |
| DU-M8502 | 86 | EFM-PS-10102-RD | 10, 106, 121 | FH-M2360-HDBK | 48 | FP-SC500-WH | 135 |
| DU-M8503 | 86 | EFM-PS-10103-RD | 10, 106, 121 | FH-M2748 | 48 | FP-SC1000-WH | 135 |
| DU-SY4572 | 87 | EFM-PS-10104 | 10, 121 | FH-W348 | 47 | FP-SC1500-WH | 135 |
| DU-SY4573 | 87 | EFM-RW3501 | 120 | FH-W348-78 | 47 | FP-SC2000-WH | 135 |
| | | | | FH-W354 | 47 | FP-SCR110-WH | 136 |
| | | | | FH-W354-118NT-CH | 47 | FP-SCR111-WH | 136 |
| | | | | FH-W354-118T | 47, 53 | FP-SCR811-WH | 136 |
| | | | | FH-W354MT | 47 | FP-SCR812-WH | 136 |
| | | | | FH-W354NT-1 | 47 | FP-SCR813-WH | 136 |
| | | | | FH-W360 | 47 | FP-SCR814-WH | 136 |
| | | | | FH-W360-1T | 47, 52, 53, 86 | FP-SCR9203 | 131 |
| | | | | FH-W360-118MT | 47 | FP-SH11 | 137 |
| | | | | FH-W360-118NT-CH | 43, 47 | FP-SH14 | 137 |
| | | | | FH-W360-118T | 47, 53 | FP-TB9C | 130 |
| | | | | FH-W360MT | 47 | FP-TL9110 | 49, 124 |
| | | | | FH-W360NT | 47 | FP-TW5105 | 132 |
| | | | | FH-W396-MT | 47 | FP-TW5110 | 132 |
| | | | | FLD-200 | 119 | FP-TW5115 | 132 |
| | | | | FLD-300 | 119 | FP-TW5120 | 132 |
| | | | | FM-P1000 | 116 | FP-TW5130 | 132 |
| | | | | FM-P1001 | 116 | FP-TW5210 | 133 |
| | | | | FP-AB12C | 128 | FP-TW5225 | 133 |

E

| | |
|----------------------------|-----|
| EFM-DB3500 | 120 |
| EFM-DB3500 + EFM-RW3501 | 120 |
| EFM-DB4500 | 120 |
| EFM-DB4510 | 120 |
| EFM-DP3510 | 120 |
| EFM-DP3511 | 120 |
| EFM-FM5100-BL | 118 |
| EFM-FM5100-GN | 118 |
| EFM-FM5100-GR | 118 |
| EFM-FM5100-RD | 118 |
| EFM-FM5100-WH | 118 |
| EFM-FM5100-YE | 118 |
| EFM-FM5200 | 119 |
| EFM-FM5200-T | 119 |

F

| | |
|-----------------|-----------------------|
| FH-A35 | 47, 52, 86 |
| FH-A36 | 47, 51, 52, 136 |
| FH-A37 | 52 |
| FH-A40 | 130 |
| FH-A360 | 48 |
| FH-A360-Colours | 48 |
| FH-A361 | 48 |
| FH-A361-Colours | 48 |
| FH-A3160 | 48 |
| FH-A3160-T | 48 |
| FH-A3180 | 48, 86, 113, 116, 118 |
| FH-A3648-GN | 48 |
| FH-F330-WH | 49 |
| FH-F348-Colour | 49 |
| FH-F354-BL | 49, 125 |

| | |
|-------------|---------|
| FP-TW5280SS | 133 |
| FP-TW5290 | 133 |
| FP-UB13C | 128 |
| FS-1619-WH | 99 |
| FS-6224-BL | 99 |
| FS-6224-GR | 99 |
| FS-6224-RD | 99 |
| FS-7210-WH | 99 |
| FS-8211-BL | 99 |
| FS-8211-RD | 99 |
| FS-8211-WH | 99 |
| FS-9224-YE | 87, 99 |
| FS-C524 | 53 |
| FS-C536 | 53 |
| FS-M18 | 52 |
| FS-M22 | 52 |
| FS-M622 | 52 |
| FS-MB220-WH | 125 |
| FS-MB224-BL | 50, 125 |
| FS-MB224-GN | 50, 125 |
| FS-MB224-RD | 50, 125 |
| FS-MB224-WH | 50, 125 |
| FS-MB224-YE | 50, 125 |
| FS-MH18 | 52 |
| FS-MH22 | 52 |
| FS-MH22-RD | 52 |
| FS-MH30 | 52 |
| FS-MH30-RD | 52 |
| FS-MP10-WH | 105 |
| FS-MP18-YE | 50 |
| FS-MP24-BL | 50 |
| FS-MP24-GN | 50 |
| FS-MP24-RD | 50 |
| FS-MP24-WH | 50 |
| FS-MP24-YE | 50 |
| FS-MP30-WH | 50 |
| FS-MPS18 | 51 |
| FS-MPS22 | 51 |
| FS-P4518 | 51 |
| FS-P5522 | 51 |
| FS-P7530 | 51 |
| FS-S18R | 53 |
| FS-S24R | 53 |
| FS-S518 | 53 |
| FS-S524 | 53 |
| FS-S524-54 | 53 |
| FS-S530 | 53 |
| FS-S536 | 53 |

H

| | |
|--------------|-----|
| HC-2900 | 126 |
| HW-145M | 76 |
| HW-145W | 76 |
| HW-160A | 76 |
| HW-160F | 76 |
| HW-160M | 76 |
| HW-160W | 76 |
| HW-1254W | 76 |
| HW-7000F | 75 |
| HW-7000F-FD | 75 |
| HW-7000F-GN | 75 |
| HW-7000F-OR | 75 |
| HW-7000F-RD | 75 |
| HW-7000F-WH | 75 |
| HW-7000F-YE | 75 |
| HW-7001F | 75 |
| HW-7002W | 76 |
| HW-7003A | 76 |
| HW-7003M | 76 |
| HW-7004A-TEL | 76 |
| HW-8054F-BL | 76 |
| HW-8060F-BL | 76 |
| HW-8160-M | 76 |
| HW-9054F-BL | 76 |
| HW-9060F-BL | 76 |
| HW-9160-M | 76 |
| HW-PC-80016 | 71 |
| HW-PC-80016C | 71 |
| HW-PC-80020 | 71 |
| HW-PC-80020C | 71 |
| HW-PC-80024 | 71 |
| HW-PC-80024C | 71 |
| HW-PC-90020 | 71 |

L

| | |
|---------|----|
| LS-1171 | 24 |
| LS-1172 | 24 |
| LS-1173 | 24 |
| LS-2100 | 24 |

M

| | |
|-----------|----|
| MC-500-BL | 97 |
| MC-501-GN | 97 |
| MC-501GN | 97 |

| | |
|---------------|---------|
| MC-502-RD | 97 |
| MC-503-YE | 97 |
| MC-504-OR | 97 |
| MC-520-BL | 97 |
| MC-521-GN | 97 |
| MC-522-RD | 97 |
| MC-523-YE | 97 |
| MC-580-BL | 97 |
| MC-581-GN | 97 |
| MC-582-RD | 97 |
| MC-583-YE | 97 |
| MC-600-BL | 97 |
| MC-601-GN | 97 |
| MC-602-RD | 97 |
| MC-603-YE | 97 |
| MC-620-BL | 97 |
| MC-621-GN | 97 |
| MC-622-RD | 97 |
| MC-623-YE | 97 |
| MC-700 | 97 |
| MC-700BL | 141 |
| MFF-7410 | 113 |
| MFF-7416 | 113 |
| MFF-7418 | 113 |
| MFF-7424 | 113 |
| MFF-7436 | 113 |
| MFK-V7418-Kit | 114 |
| MFK-V50018 | 114 |
| MFK-V60016 | 114 |
| MFK-V70016 | 115 |
| MFK-V80016 | 114 |
| MFK-V90018 | 115 |
| MFP-4010-BL | 85, 110 |
| MFP-4018-BL | 110 |
| MFP-4018-GN | 110 |
| MFP-4018-RD | 110 |
| MFP-4018-YE | 110 |
| MFP-4024-BL | 110 |
| MFP-4036-BL | 110 |
| MFP-5010-BL | 101 |
| MFP-5012-BL | 101 |
| MFP-5018-BL | 101 |
| MFP-5018-GN | 101 |
| MFP-5018-RD | 101 |
| MFP-5518 | 110 |
| MFP-5524 | 110 |
| MFP-5536 | 110 |
| MFP-6018-GY | 101 |

| | |
|--------------|----------|
| MFP-V4210-BL | 112 |
| MFP-V4210-GN | 112 |
| MFP-V4210-RD | 112 |
| MFP-V4210-YE | 112 |
| MFP-V4216-BL | 112, 116 |
| MFP-V4216-GN | 112 |
| MFP-V4216-RD | 112 |
| MFP-V4216-YE | 112 |
| MFP-V4218-BL | 112 |
| MFP-V4218-GN | 112 |
| MFP-V4218-RD | 112 |
| MFP-V4218-YE | 112 |
| MFP-V4224-BL | 112 |
| MFP-V4224-GN | 112 |
| MFP-V4224-RD | 112 |
| MFP-V4224-YE | 112 |
| MFP-V4236-BL | 112 |
| MFP-V4236-GN | 112 |
| MFP-V4236-RD | 112 |
| MFP-V4236-YE | 112 |
| MFP-V4310 | 111 |
| MFP-V4316 | 111 |
| MFP-V4318 | 111 |
| MFP-V4324 | 111 |
| MFP-V4336 | 111 |
| MFP-V5210-GY | 111 |
| MFP-V5216-GY | 111, 116 |
| MFP-V5218-GY | 111 |
| MFP-V5224-GY | 111 |
| MFP-V5236-GY | 111 |
| MW-BM16 | 70 |
| MW-BM20 | 70 |
| MW-BM24 | 70 |
| MW-CC12 | 65 |
| MW-CC12B | 66 |
| MW-CC12WB | 65 |
| MW-CC12WBB | 66 |
| MW-CC16 | 65 |
| MW-CC16# | 67 |
| MW-CC16B | 66 |
| MW-CC16B# | 67 |
| MW-CC16FTB | 66 |
| MW-CC16WB | 65 |
| MW-CC16WBB | 66 |
| MW-CC16WBB# | 67 |
| MW-CC20 | 65 |
| MW-CC20# | 67 |
| MW-CC20B | 66 |



| | | | | | | | |
|--------------|----|---------------|----|------------------|----|------------------|----|
| MW-CC20B# | 67 | MW-MM24-RD | 71 | MW-SC28WBB | 63 | MW-SLR13XL-WB-OR | 55 |
| MW-CC20FTB | 66 | MW-MM32-BL | 71 | MW-SC32 | 62 | MW-SLR13XL-WB-WH | 55 |
| MW-CC20WB | 65 | MW-MPE1S-NB | 61 | MW-SC32B | 63 | MW-SS11920 | 70 |
| MW-CC20WBB | 66 | MW-MPE2M-NB | 61 | MW-SC32B# | 63 | MW-SS11924 | 70 |
| MW-CC20WBB# | 67 | MW-MPE3L-NB | 61 | MW-SC32FTB | 64 | MW-SW1S-NB-BL | 56 |
| MW-CC24 | 65 | MW-MPE4XL-NB | 61 | MW-SC32WB | 62 | MW-SW1S-NB-GN | 57 |
| MW-CC24# | 67 | MW-MPE10S-WB | 61 | MW-SC32WBB | 63 | MW-SW1S-NB-OR | 57 |
| MW-CC24B | 66 | MW-MPE11M-WB | 61 | MW-SC32WBB# | 63 | MW-SW2M-NB-BL | 56 |
| MW-CC24B# | 67 | MW-MPE12L-WB | 61 | MW-SL1S-NB | 64 | MW-SW2M-NB-GN | 57 |
| MW-CC24FTB | 66 | MW-MPE13XL-WB | 61 | MW-SL2M-NB | 64 | MW-SW2M-NB-OR | 57 |
| MW-CC24WB | 65 | MW-MPEC12 | 61 | MW-SL3L-NB | 64 | MW-SW3L-NB-BL | 56 |
| MW-CC24WBB | 66 | MW-MPEC12-WB | 61 | MW-SL4XL-NB | 64 | MW-SW3L-NB-GN | 57 |
| MW-CC24WBB# | 67 | MW-MPEC16 | 61 | MW-SL10S-WB | 64 | MW-SW3L-NB-OR | 57 |
| MW-CC32 | 65 | MW-MPEC16-WB | 61 | MW-SL11M-WB | 64 | MW-SW4XL-NB-BL | 56 |
| MW-CC32# | 67 | MW-MPEC20 | 61 | MW-SL12L-WB | 64 | MW-SW4XL-NB-GN | 57 |
| MW-CC32B | 66 | MW-MPEC20-WB | 61 | MW-SL13XL-WB | 64 | MW-SW4XL-NB-OR | 57 |
| MW-CC32B# | 67 | MW-MPEC24 | 61 | MW-SLR1S-NB-BL | 54 | MW-SW10S-WB-BL | 56 |
| MW-CC32FTB | 66 | MW-MPEC24-WB | 61 | MW-SLR1S-NB-GN | 54 | MW-SW10S-WB-GN | 57 |
| MW-CC32WB | 65 | MW-MPEC32 | 61 | MW-SLR1S-NB-OR | 54 | MW-SW10S-WB-OR | 57 |
| MW-CC32WBB | 66 | MW-MPEC32-WB | 61 | MW-SLR1S-NB-WH | 54 | MW-SW11M-WB-BL | 56 |
| MW-CC32WBB# | 67 | MW-RF2090 | 70 | MW-SLR2M-NB-BL | 54 | MW-SW11M-WB-GN | 57 |
| MW-CL1S-NB | 66 | MW-SC12 | 62 | MW-SLR2M-NB-GN | 54 | MW-SW11M-WB-OR | 57 |
| MW-CL2M-NB | 66 | MW-SC12B | 63 | MW-SLR2M-NB-OR | 54 | MW-SW12L-WB-BL | 56 |
| MW-CL3L-NB | 66 | MW-SC12FTB | 64 | MW-SLR2M-NB-WH | 54 | MW-SW12L-WB-GN | 57 |
| MW-CL4XL-NB | 66 | MW-SC12WBB | 63 | MW-SLR3L-NB-BL | 54 | MW-SW12L-WB-OR | 57 |
| MW-CL10S-WB | 66 | MW-SC16 | 62 | MW-SLR3L-NB-GN | 54 | MW-SW12-NB-BL | 58 |
| MW-CL11M-WB | 66 | MW-SC16B | 63 | MW-SLR3L-NB-OR | 54 | MW-SW12-WB-BL | 58 |
| MW-CL12L-WB | 66 | MW-SC16B# | 63 | MW-SLR3L-NB-WH | 54 | MW-SW13XL-WB-BL | 56 |
| MW-CL13XL-WB | 66 | MW-SC16FTB | 64 | MW-SLR4XL-NB-BL | 54 | MW-SW13XL-WB-GN | 57 |
| MW-CS16 | 69 | MW-SC16WB | 62 | MW-SLR4XL-NB-GN | 54 | MW-SW13XL-WB-OR | 57 |
| MW-CS20 | 69 | MW-SC16WBB | 63 | MW-SLR4XL-NB-OR | 54 | MW-SW16-NB-BL | 58 |
| MW-CS24 | 69 | MW-SC16WBB# | 63 | MW-SLR4XL-NB-WH | 54 | MW-SW16-WB-BL | 58 |
| MW-HS16B | 69 | MW-SC20 | 62 | MW-SLR09XS-NB-BL | 54 | MW-SW20-NB-BL | 58 |
| MW-HS20B | 69 | MW-SC20B | 63 | MW-SLR09XS-WB-BL | 55 | MW-SW20-WB-BL | 58 |
| MW-HS24B | 69 | MW-SC20B# | 63 | MW-SLR10S-WB-BL | 55 | MW-SW24-NB-BL | 58 |
| MW-LFB16BB | 69 | MW-SC20FTB | 64 | MW-SLR10S-WB-GN | 55 | MW-SW24-WB-BL | 58 |
| MW-LFB20BB | 69 | MW-SC20WB | 62 | MW-SLR10S-WB-OR | 55 | MW-SW32-NB-BL | 58 |
| MW-LFB24BB | 69 | MW-SC20WBB | 63 | MW-SLR10S-WB-WH | 55 | MW-SW32-WB-BL | 58 |
| MW-LFC16B | 68 | MW-SC20WBB# | 63 | MW-SLR11M-WB-BL | 55 | MW-SWC12-BL | 59 |
| MW-LFC20B | 68 | MW-SC24 | 62 | MW-SLR11M-WB-GN | 55 | MW-SWC16-BL | 59 |
| MW-LFC24B | 68 | MW-SC24B | 63 | MW-SLR11M-WB-OR | 55 | MW-SWC16-GN | 59 |
| MW-LFR16B | 68 | MW-SC24B# | 63 | MW-SLR11M-WB-WH | 55 | MW-SWC16-OR | 59 |
| MW-LFR20B | 68 | MW-SC24FTB | 64 | MW-SLR12L-WB-BL | 55 | MW-SWC20-BL | 59 |
| MW-LFR24B | 68 | MW-SC24WB | 62 | MW-SLR12L-WB-GN | 55 | MW-SWC20-GN | 59 |
| MW-MM16-BL | 71 | MW-SC24WBB | 63 | MW-SLR12L-WB-OR | 55 | MW-SWC20-OR | 59 |
| MW-MM20-BL | 71 | MW-SC24WBB# | 63 | MW-SLR12L-WB-WH | 55 | MW-SWC24-BL | 59 |
| MW-MM20-RD | 71 | MW-SC28 | 62 | MW-SLR13XL-WB-BL | 55 | MW-SWC24-GN | 59 |
| MW-MM24-BL | 71 | MW-SC28B | 63 | MW-SLR13XL-WB-GN | 55 | MW-SWC24-OR | 59 |

| | | | | | | | |
|----------------|-----|-------------|---------|---------------|----|------------------|-----|
| RT-DB-9185 | 139 | SP-HSPB | 102 | TS-B2711 | 91 | WA-US31 | 95 |
| RT-DB-9338 | 140 | SP-HSPI | 102 | TS-B2720 | 91 | WA-US32 | 95 |
| RT-DM-9217 | 139 | SP-SM115 | 102 | TS-B2721 | 91 | WA-US33 | 95 |
| RT-FB-9235 | 139 | SP-SS50 | 102 | TS-B2738 | 91 | WF-7000 | 15 |
| RT-FM-9250 | 140 | SP-SSS | 102 | TS-BT289-12 | 90 | WF-7003 | 15 |
| RT-FM-9251 | 140 | SP-UT-BK | 102 | TS-BT289-12-2 | 90 | WF-7003-BK | 15 |
| RT-GB-9196 | 139 | SP-UT-BL | 102 | TS-BT289W-12 | 90 | WF-7005 | 15 |
| RT-IB-9307 | 140 | SP-UT-BN | 102 | TS-BT290-12 | 90 | WF-7006 | 15 |
| RT-MB-9237 | 140 | SP-UT-WH | 102 | TS-BT290-12-2 | 90 | WF-7007 | 15 |
| RT-NB-9319 | 140 | STA-2368 | 116 | TS-BT290W-12 | 90 | WF-7008 | 15 |
| RT-PL-9326 | 140 | STA-2369 | 116 | TS-PP6000 | 91 | WF-7011 | 15 |
| RT-SB9175 | 139 | STA-2370 | 116 | | | WF-7012 | 15 |
| RT-SD-9174 | 139 | STA-2371 | 116 | | | WF-C2828 | 15 |
| RT-TB-9310 | 140 | | | | | WF-C9020 | 15 |
| RT-TB-9311 | 140 | | | | | WF-C9021 | 15 |
| RT-TB-9313 | 140 | | | | | WF-C9021-SP | 15 |
| RT-TB-9314 | 140 | TB-96000 | 94, 140 | WA-209 | 94 | WF-D9002 | 15 |
| RT-TB-9315 | 140 | TL-101 | 49 | WA-210 | 94 | WF-P2020 | 15 |
| RT-WW-9312 | 140 | TL-104 | 49 | WA-2025 | 94 | WM-AC4001 | 18 |
| RYC-0108-BE-GN | 20 | TM-600 | 141 | WA-2026 | 94 | WM-AC4001 | 18 |
| RYC-0311 | 20 | TO-P11 | 14 | WA-AR500 | 92 | WM-D4000 | 18 |
| RYC-0517 | 20 | TO-P12 | 14 | WA-AR501 | 92 | WM-PR0260 | 19 |
| RYC-1248 | 21 | TO-P1850 | 18 | WA-AR502 | 92 | WM-PR1010-WH | 138 |
| RYC-1360-GN | 22 | TS5911-BL | 89 | WA-AR503 | 92 | WM-PR1010-WH-L | 138 |
| RYC-1622-L | 21 | TS5911-RD | 89 | WA-AR504 | 92 | WM-PR2020-BL-RYC | 16 |
| RYC-1660 | 21 | TS5911-WH | 89 | WA-AR505 | 92 | WM-PR2020G-FL | 18 |
| RYC-2290 | 21 | TS5914-GN | 89 | WA-AR506 | 92 | WM-PR2323-BK | 18 |
| RYC-2290-L | 21 | TS5930-WH | 89 | WA-AR507 | 92 | WM-PR2323-BL-RYC | 18 |
| | | TS5932-RD | 89 | WA-AR508 | 92 | WM-PR2323-GN | 18 |
| | | TS-6000 | 91 | WA-P101 | 96 | WM-PR2323-GY | 18 |
| | | TS-6002 | 91 | WA-PU0003 | 95 | WM-PR2324-BL | 18 |
| | | TS-6010 | 91 | WA-PU0016 | 95 | WM-PR2325-BK | 18 |
| | | TS6019 | 89 | WA-SD710 | 93 | WM-PR2325-GY | 18 |
| | | TS-B16 90 | | WA-SD711 | 93 | WM-PR2330D | 18 |
| | | TS-B289-ER | 90 | WA-SD712 | 93 | WM-PR3232BK-DO | 17 |
| | | TS-B289W-2 | 90 | WA-SD962-L | 93 | WM-PR3232-BL-RYC | 16 |
| | | TS-B289W-PL | 90 | WA-SD963-F | 93 | WM-PR3232G-FL | 18 |
| | | TS-B290-2 | 90 | WA-SDS1 | 93 | WM-PR4444-BL-RYC | 16 |
| | | TS-B290W-2 | 90 | WA-T146 | 96 | WM-PR4455BK-DO | 17 |
| | | TS-B290W-PL | 90 | WA-T150 | 96 | WM-PRH1010-GY | 16 |
| | | TS-B2300 | 90 | WA-US1 | 95 | WM-PRH1010-L-WH | 17 |
| | | TS-B2300-PL | 90 | WA-US2 | 95 | WM-PRH1010-WH | 16 |
| | | TS-B2300W | 90 | WA-US3 | 95 | WM-PRH2020-BL | 16 |
| | | TS-B2301 | 90 | WA-US19 | 95 | WM-PRH2020-GN | 16 |
| | | TS-B2301-WH | 90 | WA-US20 | 95 | WM-PRH2020-GY | 16 |
| | | TS-B2700 | 91 | WA-US21 | 95 | WM-PRH2020-L-BL | 17 |
| | | TS-B2700-V | 91 | WA-US22 | 95 | WM-PRH2020-L-GN | 17 |
| | | TS-B2701 | 91 | WA-US23 | 95 | WM-PRH2020-L-RD | 17 |
| | | TS-B2710 | 91 | WA-US24 | 95 | WM-PRH2020-L-WH | 17 |
| | | | | WA-US30 | 95 | WM-PRH2020-L-YE | 17 |

W

S



| | | | | | | | |
|-----------------|-----|-------------|---------|-------------|-----|-------------------|----|
| WM-PRH2020-RD | 16 | WS-BR00 | 104 | WS-TB10 | 105 | YM12 | 74 |
| WM-PRH2020-WH | 16 | WS-BR01 | 104 | WS-TB14 | 105 | YM16 | 74 |
| WM-PRH2020-YE | 16 | WS-BR12 | 104 | WS-TB18 | 105 | YM-HY8 | 74 |
| WM-PRH3232-BL | 16 | WS-BR14 | 104 | WS-TBP10 | 105 | YM-HY10 | 74 |
| WM-PRH3232-GN | 16 | WS-BR18 | 104 | WS-TBP14 | 105 | YM-HY12 | 74 |
| WM-PRH3232-GY | 16 | WS-BR22 | 104 | WS-TBP18 | 105 | YM-HY16 | 74 |
| WM-PRH3232-L-BL | 17 | WS-CL-15060 | 107 | WS-TBS10 | 105 | YM-HY20 | 74 |
| WM-PRH3232-L-GN | 17 | WS-CL-15061 | 107 | WS-TBS14 | 105 | YM-S8 74 | |
| WM-PRH3232-L-RD | 17 | WS-CS1021-P | 107 | WS-TBS18 | 105 | YM-S10 | 74 |
| WM-PRH3232-L-WH | 17 | WS-LS9537 | 24 | WS-TBS22 | 105 | YM-S10-54 | 74 |
| WM-PRH3232-L-YE | 17 | WS-P00 | 104 | WS-TP08-2 | 108 | YM-S12 | 74 |
| WM-PRH3232-RD | 16 | WS-PL12 | 105 | WS-TP09-3 | 108 | YM-S16 | 74 |
| WM-PRH3232-WH | 16 | WS-PL18 | 105 | WS-TP12-2 | 108 | YM-S20 | 74 |
| WM-PRH3232-YE | 16 | WS-PT200 | 37 | WS-TP16-3 | 108 | YM-Y108C | 73 |
| WM-PRH4444-BL | 16 | WS-PT201 | 37 | WS-TP16-4 | 108 | YM-Y108C-M348M | 73 |
| WM-PRH4444-GN | 16 | WS-PT202 | 37 | WS-TP20-3 | 108 | YM-Y110C | 73 |
| WM-PRH4444-GY | 16 | WS-RU12 | 104 | WS-TP20-4 | 108 | YM-Y110C-M348M | 73 |
| WM-PRH4444-L-BL | 17 | WS-RU14 | 104 | WS-TP30-3 | 108 | YM-Y112C | 73 |
| WM-PRH4444-L-GN | 17 | WS-RU18 | 104 | WS-TP100-M | 108 | YM-Y112C-M348M | 73 |
| WM-PRH4444-L-RD | 17 | WS-RU22 | 104 | WS-TP100-P | 108 | YM-Y116C | 73 |
| WM-PRH4444-L-WH | 17 | WS-RU42 | 104 | WS-TP102 | 108 | YM-Y116C-M348M | 73 |
| WM-PRH4444-L-YE | 17 | WS-SC1 | 108 | WS-TP103 | 108 | YM-Y200 | 73 |
| WM-PRH4444-RD | 16 | WS-SC2 | 108 | WS-TP104 | 108 | YM-Y212 | 73 |
| WM-PRH4444-WH | 16 | WS-SC2-1 | 108 | WS-WS10 | 106 | YM-Y310 | 73 |
| WM-PRH4444-YE | 16 | WS-SC2-2 | 108 | WS-WS14 | 106 | YM-Y310-M348 | 73 |
| WM-PRH5555-GY | 16 | WS-SC4 | 109 | WS-WS18 | 106 | YM-Y312 | 73 |
| WM-PRH5555-L-WH | 17 | WS-SC12 | 109 | WS-WS22 | 106 | YM-Y412 | 70 |
| WM-PS008 | 20 | WS-SC48 | 109 | WS-WSAB14 | 106 | YM-Y412-M348 | 70 |
| WM-PS014 | 20 | WS-SC48-M | 109 | WS-WSAB18 | 106 | YM-YEC-11140 | 72 |
| WM-PS0025 | 19 | WS-SC205 | 37, 108 | WS-WSEM10 | 106 | YM-YEC-11140-M48 | 72 |
| WM-PS028 | 20 | WS-SC206 | 37 | WS-WSEM14 | 106 | YM-YMF-12200 | 72 |
| WM-PS028-BE | 20 | WS-SCR001 | 109 | WS-WSEM18 | 106 | YM-YMF-12200-M48 | 72 |
| WM-PS028-BL-RYC | 20 | WS-SCR002 | 109 | WW-940-01 | 85 | YM-YST-05025 | 72 |
| WM-PS038 | 20 | WS-SCR003 | 108 | WW-940-02 | 85 | YM-YST-050253-M48 | 72 |
| WM-PS038-BL-RYC | 20 | WS-SCR004 | 37 | WW-1749 | 85 | | |
| WM-PS0040 | 19 | WS-SCR005 | 37 | WW-1841 | 85 | Z | |
| WM-PS0060 | 19 | WS-SCR56 | 109 | WW-1849 | 85 | | |
| WM-PS0100 | 19 | WS-SCR56R | 109 | WW-1850 | 85 | ZM-1526 | 95 |
| WM-ST3008 | 22 | WS-SCR1640 | 109 | WW-17411 | 85 | | |
| WM-ST4512 | 22 | WS-SCR1641 | 109 | WW-18411-BL | 85 | | |
| WM-ST6818 | 22 | WS-SR01510 | 109 | WW-18411-GN | 85 | | |
| WM-TW12032 | 22 | WS-SR01530 | 109 | WW-18411-RD | 85 | | |
| WM-TW20855 | 22 | WS-SR01540 | 109 | WW-18411-YE | 85 | | |
| WM-TW24064 | 22 | WS-SS00 | 104 | WW-18412 | 85 | | |
| WS-AC003 | 107 | WS-SS12 | 104 | | | | |
| WS-AC004 | 107 | WS-SS14 | 104 | Y | | | |
| WS-AC005 | 86 | WS-SS18 | 104 | YM8 | 74 | | |
| WS-AC006 | 86 | WS-SS22 | 104 | YM10 | 74 | | |
| WS-AC007 | 105 | WS-SW00 | 104 | | | | |





Distributed by / Distribué par

M2 Professional Cleaning Products Ltd.

59 Talman Court, Concord ON L4K 4L5

T: 905.738.2007 | F: 905.738.2006

Toll Free: 1.844.738.2007

Email: marino@m2mfg.com

M2 Professional Cleaning Products Ltd.

59 Talman Court, Concord (Ontario) L4K 4L5

Tél.: 905.738.2007 | Téléc. : 905.738.2006

Numéro sans frais: 1.844.738.2007

Courriel : marino@m2mfg.com